

**NATIONAL
ARCHIVES
MICROFILM
PUBLICATION**

IMAGE EVALUATION TEST TARGET (QA-3)

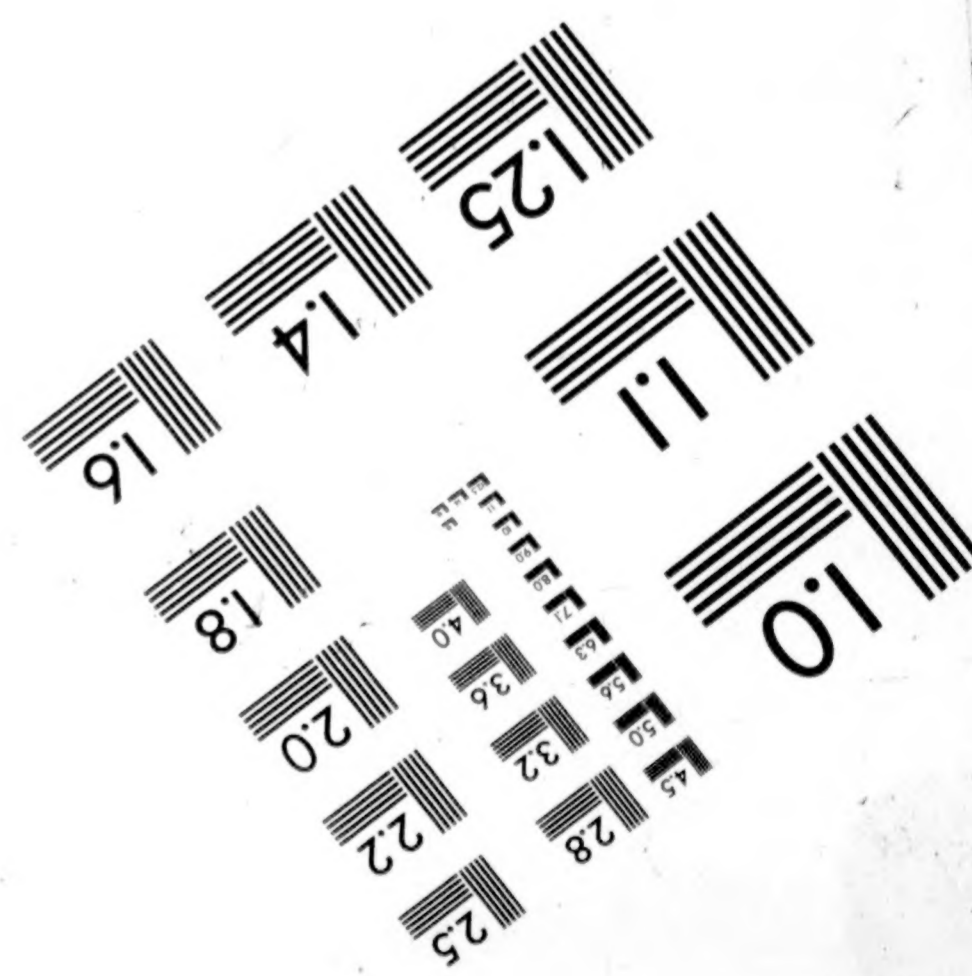
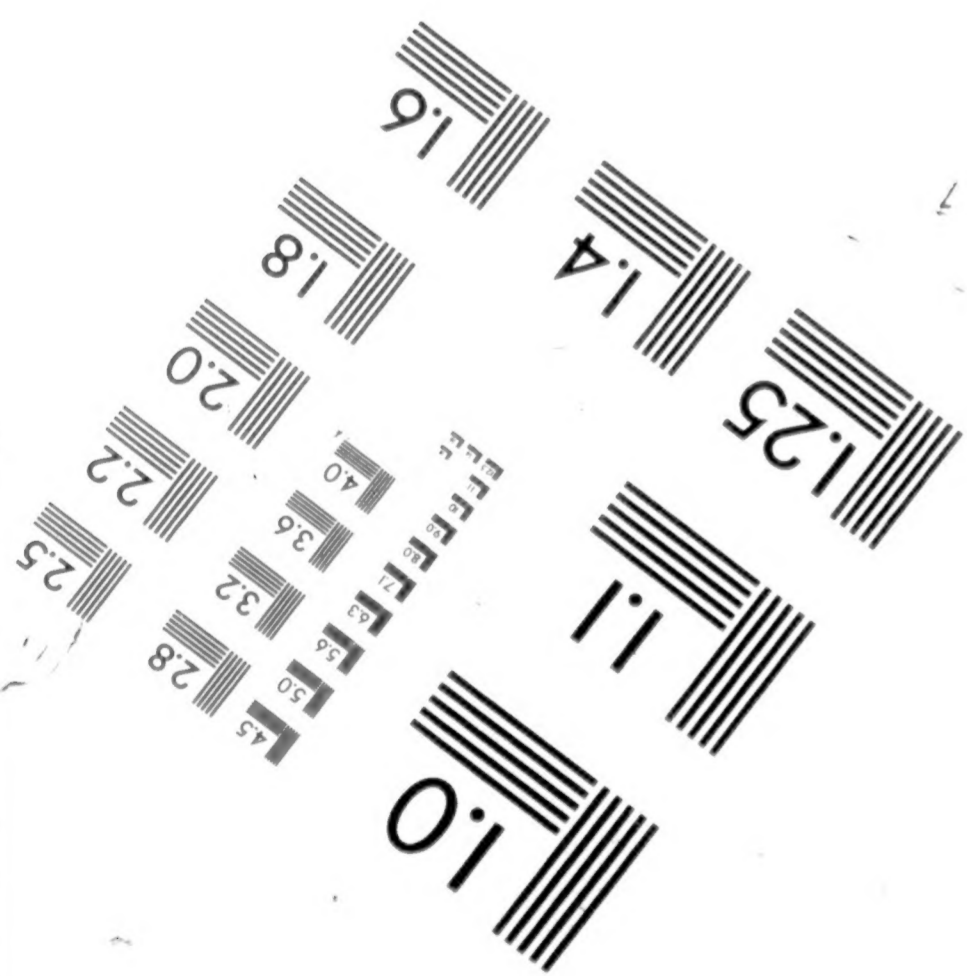
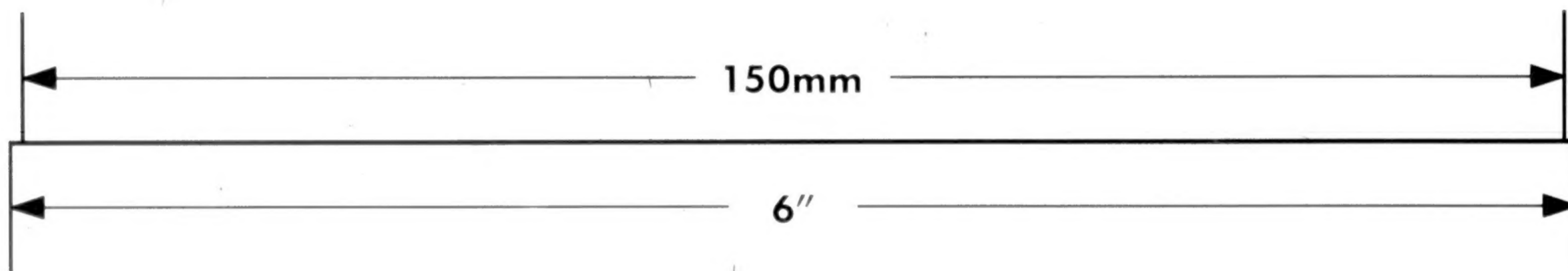
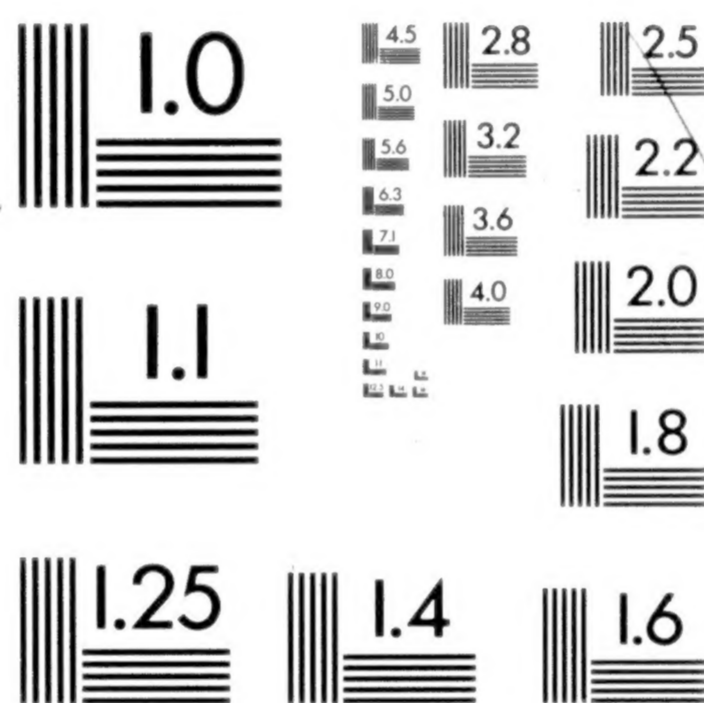
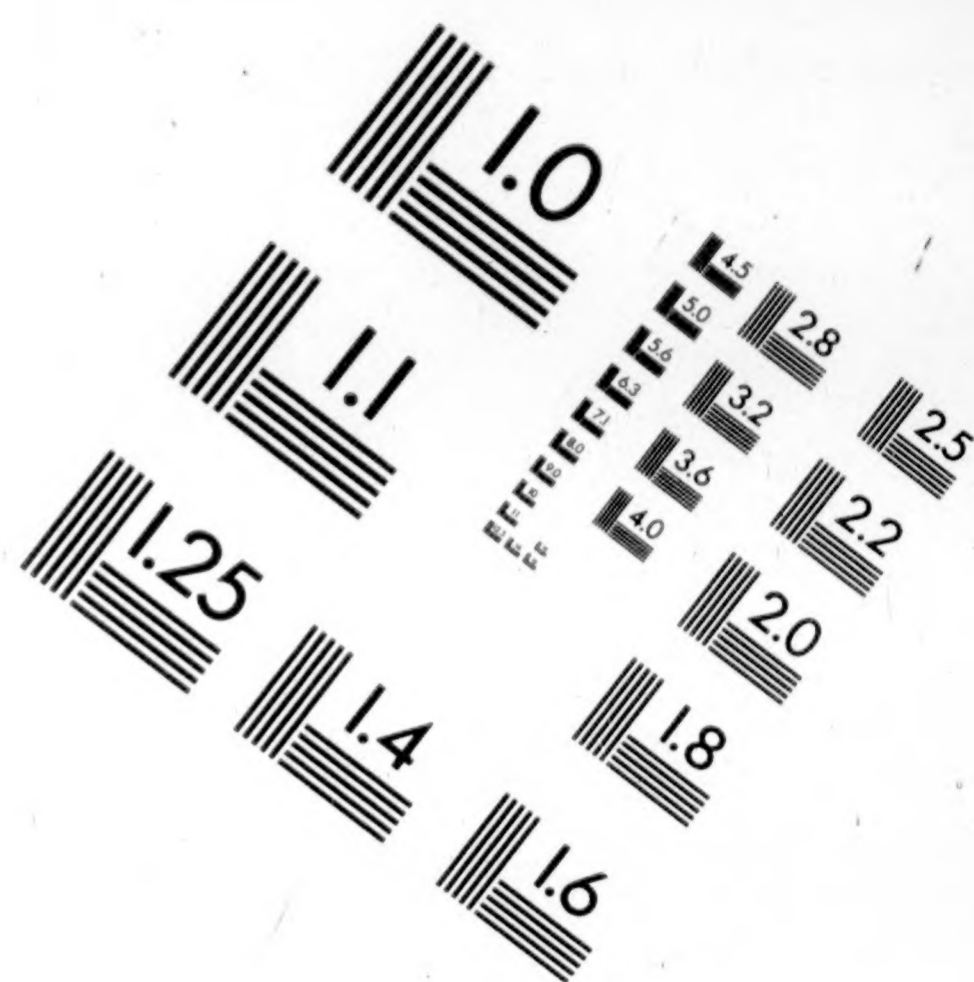
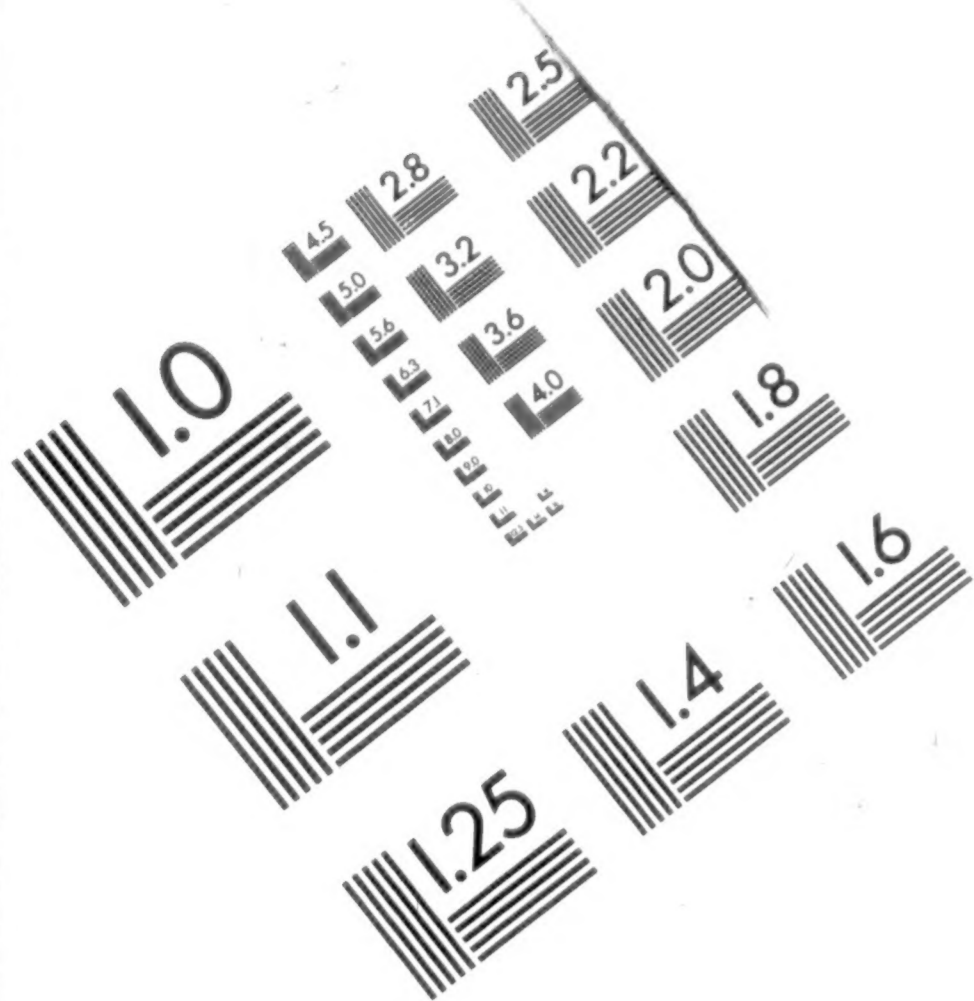

APPLIED IMAGE, Inc
 1653 East Main Street
 Rochester, NY 14609 USA
 Phone: 716/482-0300
 Fax: 716/288-5989

© 1993, Applied Image, Inc., All Rights Reserved

VW

National Archives at College Park



8601 Adelphi Road College Park MD 20740-6001

VWARE

OPERATOR

CAMERA

7-10-97

Z-4

DATE FILMED

REDUCTION RATIO

03510107

10X

FILM EMULSION NUMBER

M1817

16

PROJECT NUMBER

ROLL NUMBER

NO 11

1

6

18

1

7

NATIONAL ARCHIVES MICROFILM PUBLICATIONS

M1817

COMPILED MILITARY SERVICE RECORDS OF
VOLUNTEER UNION SOLDIERS WHO SERVED WITH THE
UNITED STATES COLORED TROOPS:
1st Through 5th United States Colored Cavalry
5th Massachusetts Cavalry (Colored)
6th United States Colored Cavalry

Introduction by Michael E. Pilgrim

Records prepared for microfilming by members of
the Civil War Conservation Corps

Budge Weidman, Project Director

Pat Alfredson	Naomi Glass	Dave Murray
Phyllis Altrogge	Sue Goward*	Ray Puzio
Kenneth Ashton	Bert Greenstein	Bill Schneider
Sue Barnard*	Anne Greenwood	Sylvia Scott
Dee Benson	Jim Harris	Lynn Shearouse
Ann N. Brown	Walter Hayden	Mary Stack-Dunne
Robert Budway	Mary Hayden	Ben Stearns
MaryAnn Castellana*	Pat Ikonen	Bill Stormer*
Mary Lou Cole	Dick Ives	Pat Sullivan
Marjory Cooper	Sarah Jaffe	Gorman Tidball*
Giovanni Croce	Barbara Kemp	Cathy Tinston
B. H. Custer	Bev Manypenny	John Toole
Bob Denney	Frank Masterson	Maryellen Toole
Richard Dow	Joe Mazur	Milt Weatherhead
Yvette Fallin	Sarah McDougall	C. Lois Young
	Ben Miles	

Team leaders are indicated by the asterisk.

National Archives and Records Administration
1997

NATIONAL ARCHIVES MICROFILM PUBLICATIONS

INTRODUCTION

On the 107 rolls of this microfilm publication, M1817, are reproduced the compiled military service records of volunteer Union soldiers belonging to the 1st through 5th United States Colored Cavalry, the 5th Massachusetts Cavalry (Colored), and the 6th United States Colored Cavalry. While the 5th Massachusetts did retain its state designation, these units were all part of the United States Colored Troops (USCT). The USCT included 7 numbered cavalry regiments; 14 numbered artillery regiments; 144 numbered infantry regiments; plus Brigade Bands Nos. 1 & 2 (Corps d'Afrique and US Colored Troops); Powell's Regiment Colored Infantry; Southard's Company Colored Infantry; Quartermaster Detachment; Pioneer Corps, 1st Division, 16th Army Corps; Unassigned Company A Colored Infantry and Unassigned USCT. The records reproduced are part of the Records of the Adjutant General's Office, 1780's-1917, Record Group (RG) 94.

Background

United States Colored Troops

Since the time of the American Revolution, African Americans have volunteered to serve their country in time of war. The Civil War was no exception. Official sanction was the difficulty. In the fall of 1862 there were four Union regiments of African Americans raised in New Orleans, LA: the 1st, 2d, and 3d Louisiana Native Guard, and the 1st Louisiana Heavy Artillery (African Descent). The 1st South Carolina Infantry (African Descent) was not officially organized until January 1863; however, three companies of the regiment were on coastal expeditions as early as November 1862. Similarly, the 1st Kansas Colored Infantry was not mustered into Federal service until January 1863, even though the regiment had already participated in the action at Island Mound, MO, on October 27, 1862. These early unofficial regiments received little Federal support, but they showed the strength of the African American soldier's desire to fight for freedom.

The first official authorization to employ African Americans in Federal service was the Second Confiscation and Militia Act of July 17, 1862. This act allowed President Abraham Lincoln to receive into the military or naval service persons of African descent and gave him permission to use them for any purpose "he may judge best for the public welfare." However, the President did not authorize use of African Americans until issuance of the Emancipation Proclamation on January 1, 1863.

In late January 1863, Gov. John Andrew of Massachusetts received permission to raise a regiment of African American soldiers. The pace of organizing additional regiments was very slow. In March Secretary of War Edwin M. Stanton sent Gen. Lorenzo Thomas to the lower Mississippi Valley to recruit

free and contraband African Americans. Thomas was given broad authority. He was to explain the administration's policy regarding African American soldiers and recruit volunteers to raise and command them. Stanton wanted all officers of such units to be white, but that policy was softened to allow African American surgeons and chaplains. By the end of the war, in addition to the chaplains and surgeons, there were some 87 African-American officers. Thomas's endeavor was very successful, and on May 22, 1863, the Bureau of Colored Troops was established to coordinate and organize regiments from all parts of the country. Created under War Department General Order No. 143, the bureau was responsible for handling "all matters relating to the organization of Colored Troops." The bureau was directly under the Adjutant General's Office and its procedures and rules were specific and strict. All African American regiments were now to be designated United States Colored Troops (USCT). At this time there were some African American regiments with state names and a few regiments in the Department of the Gulf designated as Corps d'Afrique. All these were ultimately assimilated into the USCT, even though some of the regiments, such as the 5th Massachusetts, retained their state designations.

To facilitate recruiting in the states of Maryland, Missouri, Tennessee, and eventually Kentucky, the War Department issued General Order No. 329 on October 3, 1863. Section 6 of the order stated that if any citizen should offer his or her slave for enlistment into the military service, that person would, "if such slave be accepted, receive from the recruiting officer a certificate thereof, and become entitled to compensation for the service or labor of said slave, not exceeding the sum of three hundred dollars, upon filing a valid deed of manumission and of release, and making satisfactory proof of title." For this reason, some records of manumission are contained in the compiled service records reproduced in this publication.

The USCT fought in 39 major engagements and over 400 lesser ones. Sixteen African American soldiers received Medals of Honor. As it was in other units, the death toll from disease was very high in the USCT. Deaths from disease and battle totaled 37,000. The last regiment of the USCT was mustered out of Federal service in December 1867.

Important sources for information about African American units in the Civil War are the War Department's *The War of the Rebellion: A Compilation of the Official Records of the Union and Confederate Armies* (Washington, DC: 1880-1901; reprinted Harrisburg, 1971 and 1985) and the Navy Department's *The War of the Rebellion; A Compilation of the Official Records of the Union and Confederate Navies* (Washington, DC: 1874-1922; reprinted Harrisburg, 1971 and 1985). These multivolume works contains reports of operations and other official correspondence.

1st United States Colored Cavalry

This regiment was organized at Camp Hamilton, VA, on December 22, 1863, and assigned to duty in the Department of Virginia and North Carolina. The 1st participated in Gen. Benjamin F. Butler's operations on the south side of the James River and against Petersburg and Richmond, May 4-28, 1864. These included the capture of Bermuda Hundred and City Point, VA, on May 5, and events leading up to and including the siege of Petersburg. In August 1864 it was transferred to the defenses of Portsmouth, District of Eastern Virginia. On June 10, 1865, the 1st sailed from City Point, VA, to Texas where it was assigned duty on the Rio Grande and various other areas of the state. The unit was mustered out on February 4, 1866. Compiled casualty figures are not available.

2d United States Colored Cavalry

This regiment was organized at Fort Monroe, VA, on December 22, 1863, and assigned to duty in the Department of Virginia and North Carolina. The 2d participated in Gen. Benjamin F. Butler's operations on the south side of the James River and against Petersburg and Richmond, May 4-28, 1864. These included the capture of Bermuda Hundred and City Point, VA, on May 5, and events leading up to and including the siege of Petersburg. In February 1865 it was transferred to Norfolk, District of Eastern Virginia. On June 10, 1865, the 2d sailed from City Point, VA, to Texas where it was assigned duty on the Rio Grande and various other areas of the state. The unit was mustered out on February 12, 1866. Losses included 19 killed in action and 161 dead from disease and other causes.

3d United States Colored Cavalry

Organized at Vicksburg, MS, on October 9, 1863, as the 1st Mississippi Cavalry (African Descent), this regiment was redesignated the 3d U.S. Colored Cavalry on March 11, 1864. From its organization until March 1864, the unit was attached to the District of Northeast Louisiana and from January to March 1864 participated in operations up the Yazoo River and the occupation of Yazoo City. The regiment was then transferred to the District of Vicksburg, Department of Tennessee, where it remained until December 1864. That month the unit moved to Memphis, TN, and from December 21, 1864, to January 5, 1865, participated in Gen. Benjamin Grierson's raid to destroy the Mobile & Ohio Railroad. The 3d remained on duty in Memphis and the District of West Tennessee and took part in the expedition from Memphis to Brownsville, MS, April 23-26, 1865. On April 29 the regiment returned to Vicksburg and operated around Natchez in search of fugitive Confederate President Jefferson Davis. The unit remained in the District of West Tennessee and Department of Mississippi until January 26, 1866, when it was mustered out. Losses included 37 killed in action and 367 dead from disease and other causes.

4th United States Colored Cavalry

Organized on September 12, 1863, as the 1st Corps d'Afrique Cavalry, this regiment was redesignated the 4th United States Colored Cavalry on April 4, 1864. From its organization until August 1864, it was attached to the Defenses of New Orleans, Department of the Gulf. On August 8, 1864, the 4th was ordered to Baton Rouge, LA, District of Port Hudson, and remained on duty at that post until July 1865 when it was transferred to the Department of Mississippi. It performed duties at various points in that department until it was mustered out on March 20, 1866. Compiled casualty figures are not available.

5th United States Colored Cavalry

This regiment was organized at Camp Nelson, KY, on October 24, 1864, and attached to the 1st Division, District of Kentucky, Department of Ohio. December 10-29, 1864, it participated in Stoneman's Raid into southwestern Virginia, including the capture of Saltville and the destruction of saltworks on December 20-21. In February 1865 the regiment was transferred to the Military District and Department of Kentucky until December of that year when it was ordered to the Department of Arkansas. During the latter period the unit performed mostly garrison duty. The regiment was mustered out March 20, 1866. Losses included 35 killed in action and 152 dead from disease and other causes.

5th Massachusetts Cavalry (Colored)

This regiment was organized at Camp Meigs, Reedville, MA, in the spring of 1864, and sent to Washington, DC, in May of that year. On May 13 the regiment moved to City Point, VA, where it was attached to the 18th Army Corps. Until June 16 it functioned as an infantry unit and participated in the siege of Petersburg. On June 30 it was moved to Point Lookout, MD, to guard prisoners of war. In July 1864 the regiment, still at Point Lookout, became part of the 22d Army Corps. It was transferred to the 25th Army Corps in March 1865 and ordered to the field near Richmond and Petersburg. In June the regiment was ordered to the Department of Texas where it was assigned duty at Clarksville until October 31, 1865, when it was mustered out. Losses included 7 men killed in action and 116 dead from disease and other causes.

6th United States Colored Cavalry

This regiment was organized at Camp Nelson, KY, on October 24, 1864, and attached to the 1st Division, District of Kentucky, Department of Ohio. December 10-29, 1864, it participated in Stoneman's Raid, including the destruction of the lead mines in southwestern Virginia. At the end of December the regiment returned to Camp Nelson and in February 1865 was transferred to the Military District and Department of Kentucky. It remained there until December

NATIONAL ARCHIVES MICROFILM PUBLICATIONS

1865 when it was ordered to the Department of Arkansas. The unit was mustered out on April 15, 1866. Compiled casualty figures are not available.

Records Description

Compiled service records consist of a jacket-envelope for each soldier, labeled with his name, rank, unit, and card numbers. The compilation of service records of Union soldiers began in 1890 under the direction of Col. Fred C. Ainsworth, head of the Record and Pension Office of the Adjutant General's Office, Department of War. Information from muster rolls, regimental returns, descriptive books, and other records was copied verbatim onto cards. A separate card was prepared each time an individual name appeared on a document. These cards were numbered on the back, and these numbers were entered onto the outside jacket containing the cards. The carded information was verified by a separated operation of comparison; great care was taken to ensure that the cards were accurate.

A typical jacket contains card abstracts of entries found in original records relating to the soldier and original documents relating solely to that soldier. Examples of the latter include enlistment papers, substitute certificates, casualty sheets, death reports, prisoner-of-war memorandums, and correspondence. Unique to the records of the USCT are deeds of manumission, oaths of allegiance, proof of ownership, certificates of monetary award, and bills of sale. These items appear most frequently in units recruited in the border states of Kentucky, Missouri, and Maryland. These states remained in the Union but were slave states. Jackets and cards include a section labeled "bookmark" which was reserved for cross-references to other records relating to the individual or his unit. The service records are arranged by arm of service, thereunder numerically by regiment or independent battalion or company and thereunder alphabetically by name of the soldier. Records for officers are interfiled alphabetically by name with the records of enlisted men. If an individual served in more than one unit, which was typical for USCT officers, there will be a separate service record for each unit in which he served.

Related Records

Among the records of the Adjutant General's Office in the National Archives are many of the original records that were abstracted or "carded" by the Record and Pension Office. These include the individual unit's muster rolls, returns and descriptive books. Other series in RG 94 that contain information relating to volunteer Union soldiers who served with the USCT include carded records relating to Union staff officers, carded medical records of volunteer Union soldiers, unbound and bound regimental records and "record of events" cards. The regimental records of the 54th Massachusetts Infantry (Colored) have been

NATIONAL ARCHIVES MICROFILM PUBLICATIONS

reproduced as Microfilm Publication M1659, *Records of the Fifty-fourth Massachusetts Infantry Regiment (Colored), 1863-1865*.

The "record of events" cards include information copied from the unit's muster rolls and returns. They show the stations of the field and staff and those of the various companies of the regiment at the time the muster roll or return was prepared and sometimes mention battles, skirmishes, or other activities in which the regiment participated. The cards have been reproduced as Microfilm Publication M594 *Compiled Records Showing Service of Military Units in Volunteer Union Organizations*.

Record Group 94 also includes a card index for the USCT, reproduced as Microfilm Publication M589, *Index to Compiled Military Service Records of Volunteer Union Soldiers Who Served with U.S. Colored Troops*, which may be used to locate the regiment of USCT personnel. An index card gives the name of the soldier and his rank, as well as the unit in which he served; sometimes there is a cross-reference to his service in other units or organizations. The National Archives is continually producing microfilm publications of volunteer Union compiled military service records. A complete listing of finished publications can be found in the National Archives' *Microfilm Resources for Research: A Comprehensive Catalog* which is available online at <http://www.nara.gov>.

The Records of the Colored Troops Division, within RG 94, include division correspondence and records relating to recruiting, the appointment of officers, and the slave or free status of individuals; and a compilation of historical extracts and official papers concerning the military service of African Americans from the colonial period through the Civil War entitled *The Negro in the Military Service of the United States 1639-1886*. This compilation is reproduced as Microfilm Publication M858. The Records of the Bounty and Claims Division, also in RG 94, include correspondence of the division and records relating to bounties and claims paid to loyal owners of slaves by the Slave Claims Commissions of Delaware, Kentucky, Maryland, Missouri, Tennessee and West Virginia.

If an application for a pension was made, the pension application case file may be among the Records of the Veterans Administration (RG 15). Indexes to the pension applications have been reproduced as Microfilm Publication T288, *General Index to Pension Files, 1861-1934*, and T289, *Organizational Index to Pension Files of Veterans Who Served Between 1861 and 1900*.

If a soldier or officer was tried before a general court-martial or if an individual or his unit was the subject of a court of inquiry or military commission, transcripts of the proceedings may be among the Records of the Office of the Judge Advocate General (Army) (RG 153). The registers to the proceedings have been reproduced as Microfilm Publication M1105, *Registers of the Records of the Proceedings of the U.S. Army General Courts-Martial, 1809-1890*.

NATIONAL ARCHIVES MICROFILM PUBLICATIONS

Other record groups having information pertaining to the USCT include Records of the Bureau of Refugees, Freedmen, and Abandoned Lands (RG 105); Records of the Provost Marshal General's Bureau (Civil War) (RG 110); Records of the Accounting Officers of the Department of the Treasury (RG 217); and Records of U.S. Army Continental Commands, 1821-1920 (RG 393).

NATIONAL ARCHIVES MICROFILM PUBLICATIONS

ROLL LIST

Roll Description

1st United States Colored Cavalry

- 1 Akess, Alexander - Bom, John H.
- 2 Bomer, James - Cartwright, John
- 3 Casey, Thomas - Davenport, John J.
- 4 Davis, Augustus - Floyd, George
- 5 Fly, Benjamin - Griffin, Oliver
- 6 Griffin, Quinton - Holstead, Peter
- 7 Holt, George - Jones, Herbert
- 8 Jones, Howell - Macoy, Peter
- 9 Madry, Andrew - Mosley, Jacob
- 10 Moss, James - Polk, James
- 11 Pollard, Sipio - Sales, William
- 12 Sample, Abram (Abraham) - Smith, Ives
- 13 Smith, James - Times, Nelson
- 14 Tines, Archer - Wheldon, Charles M.
- 15 Whitby, Joseph - Wilson, Isaac
- 16 Wilson, James - Zoe (no first name)

2d United States Colored Cavalry

- 17 Abbot, John - Bell, Charles
- 18 Bell, Henry - Burns, Richard
- 19 Burroughs, George L. - Cotton, Samuel
- 20 Coues, Alexander - Duncan, Levi
- 21 Dunkins, Ezikiah James - Gardner, Richard
- 22 Garris, Henry - Harrison, Thomas
- 23 Harrison, William - Humphries, David
- 24 Hunter, Francis - Jones, Robert
- 25 Jones, Robert F. - Martin, Robert (Martin)
- 26 Martin, Thaddeus or Martin, Thaddeus W. - Osborne, Henry S.
- 27 Oulden, Jacob - Prior, Edward or Edmund
- 28 Proctor, David - Sawyer, Wilson
- 29 Scabber, Charles - Stanley, William
- 30 Stanley, Wright or Right - Upshear, Neverson
- 31 Upshear, Samuel - Whites, Joe
- 32 Whites, Silas - Zodrick, Isaiah A. or Isaiah

3d United States Colored Cavalry

- 33 Aaron, John - Black, David
- 34 Black, Richard - Cameron, Wyatt

NATIONAL ARCHIVES MICROFILM PUBLICATIONS

<u>Roll</u>	<u>Description</u>
35	Cammel, Austin - Cooper, Stephen
36	Coran, Joseph - Erving, Tilson
37	Erwin, Anderson - Gool, George
38	Gordon, Alfred - Haskins, Jasper
39	Hawkins, Frank - Jackson, Harvey
40	Jackson, Henry - Kembro, Abraham
41	Kenedy, Lemuel - Lott, Judge
42	Lott, Matton - Mitchell, Berry
43	Mitchell, George - Pettis, Edmond
44	Pettis, George - Roberson, Jefferson
45	Roberson, Wallace - Simpson, Levi
46	Sims, Anderson - Taylor, Phillip
47	Taylor, Richard - Washington, Isaac
48	Washington, Oscar - Williams, Mitchel
49	Williams, Moses - Young, Mathew

4th United States Colored Cavalry

50	Abraham, Randall - Blanchan, William
51	Blanchard, Moses - Clark, Moses
52	Clark, Theodore - Ellars, James
53	Ellars, John - Heath, Culbert
54	Henderson, George - Johnson, Henderson
55	Johnson, Henry - Mayberry, Nelson
56	Macomory, John - Oliver, Celestine
57	Olsten, Alexander - Robinson, William
58	Robinson, William E. - Thomas, Stephen
59	Thomas, William - Williams, Horace
60	Williams, Isaac - Zulia, Francois

5th United States Colored Cavalry

61	Abel, Fletcher - Biggs, Randall
62	Birch, Benjamin - Burly, Frank
63	Burly, James - Coffman, James D.
64	Coke, Samuel - Dudley, John
65	Duke, John - Givens, Peter
66	Glen, John - Harriden, Edmund
67	Harrigan, Harden - Hughes, Thomas
68	Hulse, James - Keller, Ephraim
69	Kelley, Franklin - Matthews, Benjamin
70	Maupin, Preston - Murry, Ned
71	Murtney, Morton - Ray, John
72	Ray, Thomas - Sherrod, William

NATIONAL ARCHIVES MICROFILM PUBLICATIONS

Roll Description

- 73 Shrewsbury, Joseph - Stone, John
- 74 Stone, Lewis - Trye, Benjamin
- 75 Trueheart, Samuel - Williams, James
- 76 Williams, Jerry - Yowell, Joseph

5th Massachusetts Cavalry (Colored)

- 77 Abbey, David - Biers, William
- 78 Billings, Jeremiah - Burgess, Williams
- 79 Burnett, Lewis - Cook, Joseph T.
- 80 Cooper, Isaac - Dunmore, William
- 81 Durbin, Stephen - Furman, Seneca A.
- 82 Gadson, James - Gurley, Joseph L.
- 83 Guy, James - Hill, John W.
- 84 Hill, Richard - Johns, Thomas H.
- 85 Johnson, Aaron - Lambert, William
- 86 Lancaster, James - Mason, John
- 87 Mason, John H. - Nelson, Philip
- 88 Nelson, Preston - Preston, Thomas
- 89 Price, Adam - Sampson, George P.
- 90 Sanborn, Madison - Stringer, William
- 91 Strother, Frank - Vance, William H.
- 92 Van Hoesen, Charles - Wilkinson, Simon
- 93 Williams, Abram H. - Young, Thomas

6th United States Colored Cavalry

- 94 Abbot, John - Birch, James
- 95 Bivins, Gabriel - Buckner, George
- 96 Buckner, Henderson - Compton, James
- 97 Cook, Benjamin - Ellis, William
- 98 Ellis, Wyatt - Godley, Isaac
- 99 Gooch, Alexander - Herston, Abraham
- 100 Heywood, John R. - Johnson, Jackson
- 101 Johnson, James M. - Marshall, Lyman
- 102 Marshall, William - Neihardt, Isaac D.
- 103 Nelson, Joseph - Redd, Tiney
- 104 Redway, Hamilton K. - Sebree, Bob Woodcock
- 105 Sebree, Crittenden - Sumpter, John
- 106 Sutherland, Williams - Washington, Charles
- 107 Washington, George - Wren (no first name)

NATIONAL ARCHIVES MICROFILM PUBLICATIONS

Microfilm Publication M1817

COMPILED MILITARY SERVICE RECORDS OF VOLUNTEER UNION
SOLDIERS WHO SERVED WITH THE UNITED STATES COLORED
TROOPS: 1st Through 5th United States Colored Cavalry, 5th Massachusetts
Cavalry (Colored), 6th United States Colored Cavalry

Roll 16

1st United States Colored Cavalry

Wilson, James - Zoe (no first name)

NATIONAL ARCHIVES AND RECORDS ADMINISTRATION

1487
Wilson, James

Co H, 1 U. S. Col'd Cav.

Private

Corporal

CARD NUMBERS.

1	5310730	26
2	5310799	27
3	5310871	28
4	5310942	29
5	5300124	30
6	5311015	31
7	5300272	32
8	5311098	33
9	5311130	34
10	5311220	35
11	5311323	36
12	5311428	37
13	5311532	38
14	5311636	39
15	5311736	40
16	5311837	41
17	5311937	42
18	9086573	43
19	34355216	44
20		45
21		46
22		47
23		48
24		49
25		50

Book Mark: V231 P241. 76, 6261 P.M. 9 June 21/66
V81. P. 178. 69

See also

J. 611505 P.O. Off.
D 1507663 Poznan
AM. 1505837

Griffing, Cor

W | *1 Cav.* | **U.S.C.T.**

James Wilson

, Co *H*, *1* Reg't U. S. Col'd *Cav.*

Appears on

Company Descriptive Book

of the organization named above.

DESCRIPTION.

Age *19* years; height *5* feet *8* inches.

Complexion *Black*.

Eyes *Black*; hair *Black*.

Where born *Hertford N.C.*

Occupation

ENLISTMENT.

When *Dec 14*, 1863.

Where *Norfolk*.

By whom *Capt Brown*; term *3* y'rs.

Remarks: *Promoted Corporal*
Sept-10-1864.

Dickerson.

(383g)

Copyist.

61 | **1 Cav.** | **U.S.C.T.**

James H. [unclear]

Co. [unclear], 1 Reg't U. S. Col'd Cavalry.

Age years.

Appears on

Company Muster-in Roll

of the organization named above. Roll dated

 , 186 .

Muster-in to date , 186 .

Joined for duty and enrolled:

When , 186 .

Where

Period years.

Valuation of horse, \$ ¹⁰⁰

Valuation of horse equipments, \$ ¹⁰⁰

Remarks:

Book mark:

(356)

Copyist.

Q | 1 Cav. | U.S.C.T.

James Wilson

Plt, Co. H, 1 Reg't U. S. Col'd Cavalry.

Appears on

Company Muster Roll

for *Jan 25 1863*, 1863.

Present or absent *Present*

Stoppage, \$ *100* for

Due Gov't, \$ *100* for

Valuation of horse, \$ *100*

Valuation of horse equipments, \$ *100*

Remarks:

Book mark : _____

(358)

W. Edwards
Copyist.

1 Cav. U.S.C.T.

James Wilson

Co. H, 1 Reg't U. S. Col'd Cavalry.

Appears on

Company Muster Roll

for Jan 9 Feb, 1864.

Present or absent Present

Stoppage, \$ 100 for

Due Gov't, \$ 100 for

Valuation of horse, \$ 100

Valuation of horse equipments, \$ 100

Remarks:

Book mark:

James Wilson

(358)

Copyist.

01

1 Cav. U.S.C.T.

James Wilson
Private, Co. H, 1 Reg't U. S. Col'd Cavalry.

Appears on

Company Muster Roll

for *January*, 186*4*.

Present or absent *Present*

Stoppage, \$ 100 for

Due Gov't, \$ 100 for

Valuation of horse, \$ 100

Valuation of horse equipments, \$ 100

Remarks:

*Present - name
with honor
honored*

Book mark:

(358)

W. S. ...
Copyist.

25 | 1 Cav. | **U.S.C.T.**

James Wilson
Pvt, Co. 1, Reg't U. S. Col'd Cavalry

Appears on a

Detachment Muster Roll

of the organization named above

for Mar. & April, 1864.

Station Camp Hamilton, Va

Present or absent Present

Stoppage, \$ 100 for

Due Gov't, \$ 100 for

Valuation of horse, \$ 100

Valuation of horse equipments, \$ 100

Remarks :

Book mark : _____

(344)

Hammer Copyist.

1/10 | U.S.C.T.

1/10
1st, Co. 4, 1 Reg't U. S. Col'd.

Appears on

Company Muster Roll

for *1/10*, 1867.

Present or absent *Present*

Stoppage, \$ *100* for

Due Gov't, \$ *100* for

Valuation of horse, \$ *100*

Valuation of horse equipments, \$ *100*

Remarks:

1/10
1st, Co. 4, 1
1st, Co. 4, 1
1st, Co. 4, 1
1st, Co. 4, 1

Book mark:

(358)

M. A. Edwards

Copyist.

111 cav | U.S.C.T.

James Wilson

, Co., | Reg't U. S. Col'd Cav.

Appears on a

Detachment Muster Roll

of the organization named above

for May & June, 1864

Station: In the field Va. near Petersburg

Present or absent Present

Stoppage, \$ 100 for

Due Gov't, \$ 100 for

Valuation of horse, \$ 100

Valuation of horse equipments, \$ 100

Remarks:

Book mark:

Hammer

W V Cav. WSC 7

James Wilson
Priv 1 Regt U.S. Cav.

Appears on

Muster Roll

of Enlisted Men, Ambulance Corps, 2 Division,
18 Army Corps,

for *May & June*, 1864.

Station *In the Field, Va*

Clothing account:

Last settled _____, 186; drawn since \$ 100

Present or absent *Present*

Remarks:

Book mark:

Pagan

(520)

Copyist.

1 Cav. U.S.C.T.

_____, Co. H, 1 Reg't U. S. Col'd Cavalry.

Appears on

Company Muster Roll

for _____, 186__.

Present or absent _____

Stoppage, \$ _____ 100 for _____

Due Gov't, \$ _____ 100 for _____

Valuation of horse, \$ _____ 100

Valuation of horse equipments, \$ _____ 100

Remarks: _____

Book mark: _____

(358)

Copyist.

W / Cav U.S.C.T

James Wilson
 Capt, Co. H, 1 Reg't U. S. Col'd Cav

Appears on

Company Muster Roll

for Sept & Oct, 1864

Present or absent Present

Stoppage, \$ 100 for

Due Gov't, \$ 100 for

Valuation of horse, \$ 100

Valuation of horse equipments, \$ 100

Remarks: Appointed Capt
 Sept 10. 1864 per S. O. 144
 Reg Hd Qrs

Book mark:

Remmer
 Camp Copyist

(358)

24 | **1 Cav. U.S.C.T.**

James Wilson
Carp, Co. H, 1 Reg't U. S. Col'd Cavalry.

Appears on

Company Muster Roll

for *Nov & Dec*, 186*4*.

Present or absent *Present*

Stoppage, \$ *100* for

Due Gov't, \$ *100* for

Valuation of horse, \$ *100*

Valuation of horse equipments, \$ *100*

Remarks:

Book mark: -----

(358)

J. M. Jackson
Copyist.

4 | **1 Cav. | U.S.C.T.**

James Wilson
Carp, Co. H, 1 Reg't U. S. Col'd Cavalry.

Appears on

Company Muster Roll

for Jan & Feb, 1865

Present or absent Present

Stoppage, \$ 100 for

Due Gov't, \$ 100 for

Valuation of horse, \$ 100

Valuation of horse equipments, \$ 100

Remarks:

Book mark: -----

(358)

M Jackson
Copyist.

J | 1 Cav. | U.S.C.T.

James Wilson
Capt, Co. H, 1 Reg't U. S. Col'd Cavalry.

Appears on

Company Muster Roll

for *March & April*, 186*3*.

Present or absent *Present*

Stoppage, \$ *100* for

Due Gov't, \$ *100* for

Valuation of horse, \$ *100*

Valuation of horse equipments, \$ *100*

Remarks:

Book mark: -----

(358)

J M Jackson
Copyist.

22 | **1 Cav.** | **U.S.C.T.**

James Wilson
Carp, Co. H, 1 Reg't U. S. Col'd Cavalry.

Appears on

Company Muster Roll

for *May 1865*, 1865.

Present or absent *Present*

Stoppage, \$ 100 for

Due Gov't, \$ 100 for

Valuation of horse, \$ 100

Valuation of horse equipments, \$ 100

Remarks:

Book mark:

(358)

M. Jackson
Copyist.

21 | **1 Cav. | U.S.C.T.**

James Wilson

Corp, Co. H, 1 Reg't U. S. Col'd Cavalry.

Appears on

Company Muster Roll

for *July & Aug*, 186*5*.

Present or absent *Present*

Stoppage, \$ *100* for

Due Gov't, \$ *100* for

Valuation of horse, \$ *100*

Valuation of horse equipments, \$ *100*

Remarks:

Book mark: *21*

(858)

J. Jackson
Copyist.

W | 1 Cav. | U.S.C.T.

James Wilson
Corp, Co. H, 1 Reg't U. S. Col'd Cavalry.

Appears on

Company Muster Roll

for Sept & Oct, 1865.

Present or absent Present

Stoppage, \$ 100 for

Due Gov't, \$ 100 for

Valuation of horse, \$ 100

Valuation of horse equipments, \$ 100

Remarks:

Book mark:

(358)

J. H. Stewart
Copyist.

W | 1 Cav. | U.S.C.T.

Gas. Wilson
Copl., Co. H, 1 Reg't U. S. Col'd Cavalry.

Appears on

Company Muster Roll

for Nov & Dec, 1863.

Present or absent Present

Stoppage, \$ 100 for

Due Gov't, \$ 100 for

Valuation of horse, \$ 100

Valuation of horse equipments, \$ 100

Remarks:

Book mark:

(358)

J. H. Stewart

Copyist.

W | 1 Cav. | U.S.C.T.

James Wilson

Corp, Co. K, 1 Reg't U. S. Col'd Cavalry.

Appears on Co. Muster-out Roll, dated

Brazos Santiago Tex, Feb 4, 1866.

Muster-out to date Feb 4, 1866.

Last paid to Aug 31, 1865.

Clothing account:

Last settled _____, 1866 ; drawn since \$ 100

Due soldier \$ 507¹⁰⁰; due U. S. \$ 100

Am't for cloth'g in kind or money adv'd \$ 100

Due U. S. for arms, equipments, &c., \$ 100

Bounty paid \$ 100; due \$ 100

Remarks: Joined at Org. Org
Pt. until Sept 10/64

Book mark: V2.31 P27/1.76, 6261
(over)

J. H. Stewart

(361)

Copyist.

148
Wilson, James

Co I, 1 U. S. Col'd Cav.

Private Private

CARD NUMBERS.

1	5312092	26
2	5312164	27
3	5312240	28
4	5312318	29
5	5312395	30
6	5300561	31
7	5312469	32
8	5312559	33
9	5312665	34
10	5312774	35
11	5312878	36
12	5312977	37
13	5313077	38
14	5313172	39
15	5313263	40
16	5313355	41
17	9086807	42
18	9086678	43
19	40725501	44
20		45
21		46
22		47
23		48
24		49
25		50

Book Mark: _____

See also _____

H. | 1 Cav. | U.S.C.T.

James Wilson
....., Co. *D.*, 1 Reg't U.S. Col'd Cav.

Appears on

Company Descriptive Book

of the organization named above.

DESCRIPTION.

Age *27* years; height *5* feet *3* inches.

Complexion *dark*

Eyes; *dark* hair *dark*,

Where born *North Carolina*

Occupation *Labourer*

ENLISTMENT.

When *Dec. 13th 1863*

Where *Norfolk Va.*

By whom *Capt. H. Brown*; term *3* y'rs.

Remarks:

.....

.....

.....

.....

.....

.....

.....

.....

.....

(383g)

A. J. [unclear]

Copyst.

W | 1 Cav. | U.S.C.T.

James Wilson
 _____, Co. *I*, 1 Reg't U.S. Col'd Cav.

Appears on

Company Descriptive Book

of the organization named above.

DESCRIPTION.

Age *27* years; height *5* feet *13* inches.

Complexion *Dark*

Eyes; *Dark* hair *Dark*

Where born *No. Carolina*

Occupation *Laborer*

ENLISTMENT.

When *Dec. 13th 1863*

Where *Norfolk*

By whom *Capt Brown*; term *3* y'rs.

Remarks: *Sent to Genl. Hospl.*
at Ft Monroe Apr. 30th 1864
Returned from Hospl. Oct.
24th 65 Due U.S. for
Camp + Garrison C. lost
while at Hospl. \$9.80

Waggett

W | 1 Cav. | U.S.C.T.

James Wilson

Private, Co. *D*, 1 Reg't U. S. Col'd Cavalry.

Age *27* years.

Appears on

Company Muster-in Roll

of the organization named above. Roll dated

Camp Hamilton Va, Dec 22, 1863.

Muster-in to date *Dec 22, 1863.*

Joined for duty and enrolled:

When *Dec. 13th*, 1863.

Where *Norfolk Va*

Period *3* years.

Valuation of horse, \$ 100

Valuation of horse equipments, \$ 100

Remarks: _____

Book mark: _____

M. A. Michaels

(356)

Copyist.

W. | 1 Cav. | U.S.C.T.

James Wilson

Private, Co. I, 1 Reg't U. S. Col'd Cavalry.

Appears on

Company Muster Roll

for Dec. 21^d to 31st, 1863.

Present or absent present

Stoppage, \$ 100 for

Due Gov't, \$ 100 for

Valuation of horse, \$ 100

Valuation of horse equipments, \$ 100

Remarks:

Book mark:

M.A. Michaels

(358)

Copyist.

W | 1 Cav. | U.S.C.T.

James Wilson
Private, Co. I, 1 Reg't U. S. Col'd Cavalry.

Appears on

Company Muster Roll
for *James Febr.*, 1864.

Present or absent *present*

Stoppage, \$ 100 for

Due Gov't, \$ 100 for

Valuation of horse, \$ 100

Valuation of horse equipments, \$ 100

Remarks:

Book mark: -----

(358) *M. A. Michaels* Copyist.

W 1 Cav. U.S.C.T.

James Wilson
Private, Co. I, 1 Reg't U. S. Col'd Cavalry.

Appears on

Company Muster Roll
for *March & Apr*, 186*4*.

Present or absent *Present*

Stoppage, \$ *100* for

Due Gov't, \$ *100* for

Valuation of horse, \$ *100*

Valuation of horse equipments, \$ *100*

Remarks:
.....
.....
.....
.....
.....
.....
.....
.....
.....
.....

Book mark:

M. A. Michaels
(358) Copyist.

W | 1 Cav. | U.S.C.T.

James Wilson
Private, Co. I, 1 Reg't U. S. Col'd Cavalry.

Appears on

Company Muster Roll

for *May & June*, 186*4*.

Present or absent *Absent*

Stoppage, \$ *100* for

Due Gov't, \$ *100* for

Valuation of horse, \$ *100*

Valuation of horse equipments, \$ *100*

Remarks: *In Receipt at Fort Monroe Va*

Book mark:

M. A. Michaels

(358)

Copyist.

W | 1 Cav. | U.S.C.T.

James Wilson

Pvt., Co. D, 1 Reg't U. S. Col'd Cavalry

Appears on a

Detachment Muster Roll

of the organization named above

for May & June, 1864.

Station Wilson's Landing, Va

Present or absent Absent

Stoppage, \$ 100 for

Due Gov't, \$ 100 for

Valuation of horse, \$ 100

Valuation of horse equipments, \$ 100

Remarks: In Hosp'l at Fort
Mannor Va.

Book mark:

Ammer

(344)

Copyist.

W

1 Cav.

U.S.C.T.

James Hilson

Private, Co. I, 1 Reg't U. S. Col'd Cavalry.

Appears on

Company Muster Roll

for *July & Aug.*, 1864.

Present or absent *absent*

Stoppage, \$ *100* for

Due Gov't, \$ *100* for

Valuation of horse, \$ *100*

Valuation of horse equipments, \$ *100*

Remarks: *In Gen. Hoopst at
Fort Monroe since April
30th 1864*

Book mark:

M. A. Michaels

(358)

Copyist.

107 | 1 Cav. | U.S.C.T.

James Wilson
Private, Co. I, 1 Reg't U. S. Col'd Cavalry.

Appears on

Company Muster Roll

for Sept & Oct, 1864

Present or absent Absent

Stoppage, \$ 100 for

Due Gov't, \$ 100 for

Valuation of horse, \$ 100

Valuation of horse equipments, \$ 100

Remarks In Genl Hospital at Fort
Monroe Va June 30
1864

Book mark:

(358)

Copyist

W | 1 Cav. | U.S.C.T.

James Wilson

Plt, Co. I, 1 Reg't U. S. Col'd Cavalry.

Appears on

Company Muster Roll

for Nov & Dec, 1864

Present or absent

Stoppage, \$ 100 for

Due Gov't, \$ 100 for

Valuation of horse, \$ 100

Valuation of horse equipments, \$ 100

Remarks: In Gen Hopt at Fort-
Mauve since April 30 1864

Book mark:

Quitt

Copyist.

(358)

W | 1 Cav. | U.S.C.T.

James Wilson

Priv., Co. I, 1 Reg't U. S. Col'd Cavalry.

Appears on

Company Muster Roll

for *Jan & Feb*, 186*J.*

Present or absent *Absent*

Stoppage, \$ *100* for

Due Gov't, \$ *100* for

Valuation of horse, \$ *100*

Valuation of horse equipments, \$ *100*

Remarks: *In Genl Hap Horn
March June April 30
'64*

Book mark:

Cutter

Copyist.

(358)

W | 1 Cav. | U.S.C.T.

James Wilson

Mr, Co. I, 1 Reg't U. S. Col'd Cavalry.

Appears on

Company Muster Roll

for *Mar & Apr*, 1865.

Present or absent *Absent*

Stoppage, \$ *100* for

Due Gov't, \$ *100* for

Valuation of horse, \$ *100*

Valuation of horse equipments, \$ *100*

Remarks: *In Gen Hospital Fort-
Mauve since April 30th
1864*

Book mark:

Cutus
Copyist.

(358)

W | 1 Cav. | U.S.C.T.

James Wilson

nm, Co. I, 1 Reg't U. S. Col'd Cavalry.

Appears on

Company Muster Roll

for May & June, 1865.

Present or absent Absent

Stoppage, \$ 100 for

Due Gov't, \$ 100 for

Valuation of horse, \$ 100

Valuation of horse equipments, \$ 100

Remarks: In Gen Hospital at Ft Monroe since April 30 '64

Book mark:

Butts Copyist.

(358)

W | 1 Cav. | U.S.C.T.

James Wilson

M, Co. I, 1 Reg't U. S. Col'd Cavalry.

Appears on

Company Muster Roll

for July & Aug, 1865.

Present or absent Absent

Stoppage, \$ 100 for

Due Gov't, \$ 100 for

Valuation of horse, \$ 100

Valuation of horse equipments, \$ 100

Remarks: He was Capt 7th
Mansie since April 30
64

Book mark:

Copyist.

N. | 1 Cav. | U.S.C.T.

James Wilson.
Pr., Co. I, 1 Reg't U. S. Col'd Cavalry.

Appears on

Company Muster Roll

for *Sept. - Oct.*, 1865.

Present or absent *Present*

Stoppage, \$ 100 for

Due Gov't, \$ 100 for

Valuation of horse, \$ 100

Valuation of horse equipments, \$ 100

Remarks: _____

Book mark: _____

(358) *Kelly* Copyist.

77. | 1 Cav. | U.S.C.T.

James Wilson.
Pai, Co. I, 1 Reg't U. S. Col'd Cavalry.

Appears on

Company Muster Roll

for No. + Dec., 1865.

Present or absent Present

Stoppage, \$ 100 for

Due Gov't, \$ 100 for

Valuation of horse, \$ 100

Valuation of horse equipments, \$ 100

Remarks:

Book mark:

(358)

Kelley

Copyist.

W | 1 Cav. | U.S.C.T.

James Wilson

Prs, Co. I, 1 Reg't U. S. Colored Cav.

Appears on Returns as follows:

May 1864 absent sick
in Hosp. at Ft Monroe
since March 30/64

Aug & Sept 1864 absent sick
in Genl Hosp. at Ft Monroe
Va since April 30/64

Nov 1864 to Feb 1865 absent
sick at Fort Monroe Va
since April 30/64

April to Sept 1865 absent sick
in Gen Hosp at Ft Monroe
Va since April 30/64

Book mark:

Chas. Patton

(546)

Copyist.

N. | 1 Cav. | U.S.C.T.

James Wilson
Co. I, 1 Reg't U. S. Col'd Cavalry.

Appears on Co. Muster-out Roll, dated

Orange Springs, Tex, Feb. 4, 186*6*.

Muster-out to date *Feb 4*, 186*6*.

Last paid to *Jan. 1*, 186*4*.

Clothing account:

Last settled....., 186 ; drawn since \$.....100

Due soldier \$ *11.49*.....100; due U. S. \$.....100

Am't for cloth'g in kind or money adv'd \$.....100

Due U. S. for arms, equipments, &c., \$.....100

Bounty paid \$.....100; due \$.....100

Remarks: *Joined at Orig. Org.*

Book mark :

(361)

Kelley.

Copyist.

1489

Wilson, John

Co A, 1 U. S. Col'd Cav.

Private

Private

CARD NUMBERS.

1 5301105
 2 5301174
 3 5301261
 4 5301348
 5 5301434
 6 5301520
 7 5301604
 8 5301702
 9 5301815
 10 5301920
 11 5302018
 12 5302114
 13 5302209
 14 5302296
 15 5302378
 16 9085826
 17 40725550
 18
 19
 20
 21
 22
 23
 24
 25

26
 27
 28
 29
 30
 31
 32
 33
 34
 35
 36
 37
 38
 39
 40
 41
 42
 43
 44
 45
 46
 47
 48
 49
 50

Book Mark: 11619. v. 1. P. 92-68

See also

2

RP 579131

A 1704255 P.O. 21172

J. B. Dond
Ex

W | **1 Cav. | U.S.C.T.**

John Wilson
Cvt, Co. *A*, 1 Reg't U.S. Col'd Cav.

Appears on

Company Descriptive Book

of the organization named above.

DESCRIPTION.

Age *30* years; height *5* feet *3/2* inches.

Complexion *Black*

Eyes; *Black* hair *Black*

Where born *Norfolk Va*

Occupation *Farmer*

ENLISTMENT.

When *Dec 12 1863*

Where *Norfolk Va*

By whom *Capt Brown*; term *3* y'rs.

Remarks:

Houston

W | **1 Cav. | U.S.C.T.**

John Wilson
Co. *A*, 1 Reg't U. S. Col'd Cavalry.

Age *30* years.

Appears on

Company Muster-in Roll

of the organization named above. Roll dated

Camp Hamilton, Va. Dec: 22, 1863.

Muster-in to date *Dec. 22, 1863.*

Joined for duty and enrolled:

When *Dec. 12*, 1863.

Where *Norfolk, Va.*

Period *5* years.

Valuation of horse, \$ *100*

Valuation of horse equipments, \$ *100*

Remarks:

Book mark:-----

O. J. Taylor

(356)

Copyist.

JH

1 Cav. U.S.C.T.

John Wilson

Or, Co. A, 1 Reg't U. S. Col'd Cavalry.

Appears on

Company Muster Roll

for *Dec 22 to Dec 31*, 1863.

Present or absent *Present*

Stoppage, \$ *100* for

Due Gov't, \$ *100* for

Valuation of horse, \$ *100*

Valuation of horse equipments, \$ *100*

Remarks:

Book mark:

W. J. Taylor

(358)

Copyist.

W | **1 Cav.** | **U.S.C.T.**

John Wilson
OW, Co. A, 1 Reg't U.S. Col'd Cavalry.

Appears on

Company Muster Roll

for *Jan. & Feb.*, 1864.

Present or absent *Present*

Stoppage, \$ *100* for

Due Gov't, \$ *100* for

Valuation of horse, \$ *100*

Valuation of horse equipments, \$ *100*

Remarks:

Book mark: -----

D. A. Taylor
(358) *D. A. Taylor* Copyist.

W | **1 Cav. | U.S.C.T.**

John Wilson
Pr, Co. A, 1 Reg't U. S. Col'd Cavalry.

Appears on

Company Muster Roll

for *March-April*, 1864.

Present or absent *Present*

Stoppage, \$ 100 for

Due Gov't, \$ 100 for

Valuation of horse, \$ 100

Valuation of horse equipments, \$ 100

Remarks:

Book mark: -----

(358)

O. A. Taylor

Copyist.

W | 1 Cav. | U.S.C.T.

John Wilson
Plt, Co. A, 1 Reg't U. S. Col'd Cavalry.

Appears on

Company Muster Roll

for *May & June*, 1864.

Present or absent *Present*

Stoppage, \$ *100* for

Due Gov't, \$ *100* for

Valuation of horse, \$ *100*

Valuation of horse equipments, \$ *100*

Remarks:
.....
.....
.....
.....
.....
.....
.....

Book mark :

O. P. Taylor
(358) Copyist.

W | **1 Cav. | U.S.C.T.**

John Wilson
Pr, Co. A, 1 Reg't U. S. Col'd Cavalry.

Appears on

Company Muster Roll
for *July & Aug.*, 1864.

Present or absent *Present*

Stoppage, \$ *100* for

Due Gov't, \$ *100* for

Valuation of horse, \$ *100*

Valuation of horse equipments, \$ *100*

Remarks:

Book mark: _____

O. J. Taylor
(358) *O. J. Taylor* Copyist.

25 | 1 Cav. | U.S.C.T.

John Wilson

Priv; Co. A, 1 Reg't U. S. Col'd Cavalry.

Appears on

Company Muster Roll

for Sept. & Oct., 1864.

Present or absent Present

Stoppage, \$ 100 for

Due Gov't, \$ 100 for

Valuation of horse, \$ 100

Valuation of horse equipments, \$ 100

Remarks:

Book mark:

Folsom

(358)

Copyist.

20 | 1 Cav. | U.S.C.T.

John Wilson
Private, Co. A, 1 Reg't U. S. Col'd Cavalry

Appears on

Company Muster Roll

for Nov. & Dec., 1867

Present or absent Present

Stoppage, \$ 100 for

Due Gov't, \$ 100 for

Valuation of horse, \$ 100

Valuation of horse equipments, \$ 100

Remarks:

Book mark: _____

Tobman

(358)

Copyist

W | 1 Cav. | U.S.C.T.

John Wilson
Priv; Co. A, 1 Reg't U. S. Col'd Cavalry.

Appears on

Company Muster Roll

for *Jan'y & Feby*, 1865.

Present or absent *Present*

Stoppage, \$ 100 for

Due Gov't, \$ 100 for

Valuation of horse, \$ 100

Valuation of horse equipments, \$ 100

Remarks:

Book mark:

(358)

Shuman

Copyist.

23 | 1 Cav. | U.S.C.T.

John Wilson
Priv., Co. A, 1 Reg't U. S. Col'd Cavalry.

Appears on

Company Muster Roll

for March & April, 1865.

Present or absent Present

Stoppage, \$ 100 for

Due Gov't, \$ 100 for

Valuation of horse, \$ 100

Valuation of horse equipments, \$ 100

Remarks:

Book mark:

Tolman

W | **1 Cav.** | **U.S.C.T.**

John Wilson
Priv., Co. A, 1 Reg't U. S. Col'd Cavalry.

Appears on

Company Muster Roll

for May & June, 1865.

Present or absent Present

Stoppage, \$ 100 for

Due Gov't, \$ 100 for

Valuation of horse, \$ 100

Valuation of horse equipments, \$ 100

Remarks:

Book mark : _____

Tobean

(358)

Copyist.

W | 1 Cav. | U.S.C.T.

John Wilson
Priv, Co. A, 1 Reg't U.S. Col'd Cavalry.

Appears on

Company Muster Roll

for July & August, 1865.

Present or absent Present

Stoppage, \$ 100 for

Due Gov't, \$ 100 for

Valuation of horse, \$ 100

Valuation of horse equipments, \$ 100

Remarks:

Book mark:

(358)

Johnson

Copyist.

H | 1 Cav. | U.S.C.T.

John Wilson
Capt., Co. A, 1 Reg't U. S. Col'd Cavalry.

Appears on

Company Muster Roll

for *Sept and Oct.*, 186*5*.

Present or absent *Present*

Stoppage, \$ 100 for

Due Gov't, \$ 100 for

Valuation of horse, \$ 100

Valuation of horse equipments, \$ 100

Remarks:

Book mark:

D. V. Webster

(358)

Copyist.

A | 1 Cav. | U.S.C.T.

John Wilson

Capt, Co. A, 1 Reg't U. S. Col'd Cavalry.

Appears on

Company Muster Roll

for *Nov. and Dec.*, 186*7*.

Present or absent *Present*

Stoppage, \$ *100* for

Due Gov't, \$ *100* for

Valuation of horse, \$ *100*

Valuation of horse equipments, \$ *100*

Remarks:

Book mark: -----

D.P. Webster

(358)

Copyist.

W | 1 Cav. | U.S.C.T.

Comd Wilson

Priv, Co. A, 1 Reg't U. S. Colored Cav.

Appears on Returns as follows:

April 1864 Co Cook

Nov 1864 Co Cook

April & May 1865 Co Cook

Aug 1865 Co Cook

Nov & Dec 1865 Co Cook

Book mark:

Lat Patten

(546)

Copyist.

N | 1 Cav. | U.S.C.T.

John Kilorn
Prov. Co. H, 1 Reg't U. S. Col'd Cavalry.

Appears on **Co. Muster-out Roll**, dated
Brazos Santiago Tex Feb 4, 1866.
 Muster-out to date *Feb 4*, 1866.
 Last paid to *Aug 31*, 1865.

Clothing account:

Last settled _____, 1866 ; drawn since \$ _____ 100
 Due soldier \$ *27 08* / 100 ; due U. S. \$ _____ 100
 Am't for cloth'g in kind or money adv'd \$ _____ 100

Due U. S. for arms, equipments, &c., \$ _____ 100

Bounty paid \$ *none* / 100 ; due \$ _____ 100

Remarks: *joined at Big Spring*

Book mark: *11619 U.S.P. 92.68*

J.P. Webster
 (361) Copyist.

Wilson, John

Co D, 1 U. S. Col'd Cav.

Personal papers herein.

Private

Private

CARD NUMBERS.

1	5299691	26
2	5299667	27
3	5305839	28
4	5305948	29
5	W-160-05-1873	30
6	5305950	31
7	5306055	32
8	5306158	33
9	5306255	34
10	5306353	35
11	5306448	36
12	5306539	37
13	S-276-RCV-1868	38
14	40775533	39
15		40
16		41
17		42
18		43
19		44
20		45
21		46
22		47
23		48
24		49
25		50

Book Mark: W-160-05-1873
S-276-RCV-1868

See also

7 | **1 Cav. | U.S.C.T.**

John Wilson

Appears with rank of *Recruit* on

Muster and Descriptive Roll of a Detachment of U. S. Vols. forwarded

for the 1 Reg't U. S. Col'd Cavalry. Roll dated

Newport News Va Nov 26, 1864.

Where born *Petersburg Va*

Age *23* y'rs; occupation *laborer*

When enlisted *Nov 26*, 1864.

Where enlisted *Newport News*

For what period enlisted *3* years.

Eyes *brn*; hair *black*

Complexion *light*; height *5* ft. *6* in.

When mustered in *Nov 26*, 1864.

Where mustered in *Newport News.*

Bounty paid \$ *100* ¹⁰⁰; due \$ ¹⁰⁰

Where credited *Mass. 1st Eng. Det.*

Company to which assigned

Remarks:

Book mark: *W-160-QD-1873*

Conner

W | 1 Cav. | U.S.C.T.

John Wilson

Appears with rank of *Pvt* on

Muster and Descriptive Roll of a Detachment of U. S. Vols. forwarded

for the 1 Reg't U. S. Col'd Cavalry. Roll dated

Newport News Va Nov 30 1864

Where born *Petersburg Va*

Age *23* y'rs; occupation *Laborer*

When enlisted *Nov-26*, 186*4*

Where enlisted *Newport News*

For what period enlisted *3* years.

Eyes *brown*; hair *blk*

Complexion *light*; height *5* ft. *6* in.

When mustered in *Nov-26*, 186*4*

Where mustered in *Newport News*

Bounty paid \$ *100* ¹⁰⁰; due \$ ¹⁰⁰

Where credited *Major 1st Cav Dist*

Company to which assigned

Remarks :

Book mark :

News

57 | 1 Cav. | U.S.C.T.

John Wilson
Sgt, Co. D, 1 Reg't U. S. Col'd Cavalry.

Appears on

Company Muster Roll

for Nov 1864, 1864.

Present or absent Present

Stoppage, \$ 100 for

Due Gov't, \$ 100 for

Valuation of horse, \$ 100

Valuation of horse equipments, \$ 100

Remarks: Present Muster
Present Roll corrected

Book mark:

Wilson

77 | 1 Cav. | U.S.C.T.

John Wilson
Co., Co. D, 1 Reg't U. S. Col'd Cavalry.

Appears on

Company Muster Roll

for June 1867, 1867.

Present or absent Absent

Stoppage, \$ 100 for

Due Gov't, \$ 100 for

Valuation of horse, \$ 100

Valuation of horse equipments, \$ 100

Remarks: No Muster and
descriptive Piece need
detached June 5th 1867

* Not borne on sub's rolls as

George Wilson
* Corrected by H. J. April 20. 97.

Book mark:

Libanus

H | 1 Cav. | U.S.C.T.

John Wilson

Co. D, 1 Reg't U. S. Col'd Cavalry.

Appears on

Company Muster Roll

for May & July, 1867.

Present or absent Absent

Stoppage, \$ 100 for

Due Gov't, \$ 100 for

Valuation of horse, \$ 100

Valuation of horse equipments, \$ 100

Remarks: No muster and description Roll Recd from direction May 1st 1865. Now in confinement at Internment N. J. Prison with Wilson, George. See Card Recd April 1867.

Inserted by Camp * Corrected by H at April 20. 97. H. G.

Book mark:

Abrams

H | 1 Cav. | U.S.C.T.

George Wilson

W, Co. D, 1 Reg't U. S. Col'd Cavalry.

Appears on

Company Muster Roll

for *Mar Suprie*, 186*5*.

Present or absent *absent*

Stoppage, \$ *100* for

Due Gov't, \$ *100* for

Valuation of horse, \$ *100*

Valuation of horse equipments, \$ *100*

Remarks: *absent in Company
at Portsmouth*

Book mark: *Geo. W. Wilson*

Abraham

ARRA 69

JAN. - 6

5306055

#1891*

to John Wilson
~~213 Ave. 10. 544~~
w-100-09-1873

A | 1 Cav. | U.S.C.T.

George Wilson

Det, Co. D, 1 Reg't U. S. Col'd Cavalry.

Appears on

Company Muster Roll

for *May & June*, 186*4*.

Present or absent *Absent*

Stoppage, \$ *100* for

Due Gov't, \$ *100* for

Valuation of horse, \$ *100*

Valuation of horse equipments, \$ *100*

Remarks: *Absent in confinement at Portsmouth Va*

Book mark: *U.S. Name Change*

10002

Wilson

(358)

Copyist.

NARA 71

JAN. - 6

5306158

* 1891 *

John Wilson. Sec 2034
Dec. 10. 54
W-160-09-1873

11 | 1 Cav. | U.S.C.T.

George Wilson

(A), Co. D, 1 Reg't U. S. Col'd Cavalry.

Appears on

Company Muster Roll

for Nancy [unclear], 1865.

Present or absent absent

Stoppage, \$ 100 for

Due Gov't, \$ 100 for

Valuation of horse, \$ 100

Valuation of horse equipments, \$ 100

Remarks: Absent Capt in
Parliament

Book mark: [unclear] 1864

(358)

Copyist.

MARR 73

JAN. - 6

5306255

1891

to Mr. Wilson

~~1891-544~~

* W-160 @ 9-1873

H | 1 Cav. | U.S.C.T.

George Wilson

Priv., Co. D, 1 Reg't U. S. Col'd Cavalry.

Appears on

Company Muster Roll

for Sept & Oct., 1865.

Present or absent Absent

Stoppage, \$ 100 for

Due Gov't, \$ 100 for

Valuation of horse, \$ 100

Valuation of horse equipments, \$ 100

Remarks: In conf. at Portsmouth, Va. since Feb. 1, 1865.

Book mark: *EB. Vol. 10. 541.

*Corrected April 20, 1907 by Austin.

R. E. Wilson

W | 1 Cav. | U.S.C.T.

George Wilson

Pvt., Co. D, 1 Reg't U. S. Col'd Cavalry.

Appears on

Company Muster Roll

for Nov & Dec, 1865.

Present or absent Absent

Stoppage, \$ 100 for

Due Gov't, \$ 100 for

Valuation of horse, \$ 100

Valuation of horse equipments, \$ 100

Remarks: Abs. in Court. at Portsmouth, Va.

Book mark: *S.D. 402, 10-5000

*Corrected April 23, 97 by Austin

R. E. Wilson

W | 1 Cav. | U.S.C.T.

x *John Wilson*
ser, Co. *D*, 1 Reg't U. S. Colored Cav.

Appears on Returns as follows:

Jan'y 1865 Loss. *Jan'y 19/65*. *Portsmouth Va*
Deserted

Mani apprehended & returned to Co Feby 1/65.

Feb'y 1865 absent in *Confinement at Portsmouth Va*

May to Oct 1865. absent in *confinement at Portsmouth Va since Feby 1/65.*

Nov 1865 to Jan'y 1866. absent in *confinement at Portsmouth Va by sentence of Gen Court Martial since Dec 21/64*

x *Name also appears as George Wilson*

Book mark:

W. J. Patton

11 | 1 Car | **U. S. C. T.**

George Wilson

1st, Co. D, 1 Reg't U. S. Col'd Carr

Appears on **Co. Muster-out Roll**, dated

Gray's Santiago, Tex., Feb. 4, 1866.

Muster-out to date _____, 186 .

Last paid to pay due from enlistment 186 .

Clothing account:

Last settled _____, 186 ; drawn since \$ _____ 100

Due soldier \$ _____ 100 ; due U. S. \$ _____ 100

Am't for cloth'g in kind or money adv'd \$ _____ 100

Due U. S. for arms, equipments, &c., \$ _____ 100

Bounty paid \$ 100 due \$ _____ 100

Remarks: Joined as recruit Dec. 2/64.
Deserted Jan. 19/65. Apprehended Feb. 1/65.
In confinement at Fort Mifflin, Va.
by sentence G. C. M. Desc. List
furnished. No discharge furnished.

Book mark: ^{W 160. C 6-1872 *}
Name changed to John Wilson, B. 10,
1844.
S. 276, v. 5, R. C. I. 1868.
* 1161, 150-73
Transferred to prison deserts from
Kent County Dec 1/64. B. 10 1548.

* Corrected April 23/97 by Austin.

Witnessed

W. 1 Cav. U.S.C.

John Wilson
 Co. D, 1 Reg't U. S. Col. Cav.

NOTATION.

Book mark: W 160 C. J. 1873

Record and Pension Office,

WAR DEPARTMENT,

Washington, Apr. 17, 1897.

Tried by a G. C. M. convened Feb. 6, 1865, at Norfolk, Va. on the charges:

1. Desertion
2. Obtaining money under false pretenses,

found guilty of both charges and sentenced to refund to Pvt. Smith, Co. D, 1st U. S. Colored Cav., the sum of eighty dollars fraudulently obtained, and that he be confined at hard labor at such place as the commanding general shall direct for the remainder of his term of enlistment,

a. G. N. (over)

and forfeit all pay and allowances now due or to become due except the just dues of the laundry and sutler, and that he be dishonorably discharged the service at the expiration of his term of enlistment, vide G.O. #19 Dist. Eastern Va. Mch. 30. 1865.

He was received at Hard Labor Prison, Norfolk, Va., June 14, 1865, and escaped Sept. 18, 1865.

W | 1st Cav | U.S.C.S.

John Wilson

, Co. _____, 1st Reg't U.S.C.S.
Cav.

NOTATION.

Book mark: S-276-R-C-J-1868.

War Department,

Adjutant General's Office,

Washington, July 22, 1868.

Call from

()

returned with report.

The above book mark was noted on rolls in order to
preserve results of search in this case.

W. J. Allen

(475)

Copyist.

Wilson John

, Co. *D*,

Reg't *U.S.C. Cav*

2 Enclosures.

Bed Cards	Final Statements
Burial Records	Furloughs or L. of A
Certs. of Dis. for Discharge	Med. Certificates
C. M. Charges	Med. Des. Lists
Descriptive Lists	Orders
Discharge Certificates	Pris. of War Record
Enlistment Papers <i>/</i>	Resignations

Other papers relating to—

Admission to Hosp'l	Furlough or L. of A
Casualty Sheet	Med. Examination
Confinement	Misc. Information <i>/</i>
Contracts	Pay or Clothing
Death or Effects	Personal Reports
Desertion	Rank
Discharge from Hosp'l	Transfer to Hosp'l
Discharge from Service	Transfer to V. R. C.
Duty	Transportation

Note 1. This blank will be used for both enlistments and re-enlistments—enlistment of veterans, &c., &c., in the volunteer service. They will be made out in duplicate in all cases—one to accompany the recruiting return of the superintendent (not the recruiting officer) to the Adjutant-General, and one to accompany the accounts of the officer who pays bounty, &c. The Regiment and Company in which the soldier last served should be given on the back.

Note 2.—An enlistment holds to service. A muster-in must, in all cases, precede payment of pay, bounty, pension, &c. A muster-in roll must, in all cases, be filed in the Adjutant-General's Office as evidence of muster-in. The mustering officer, commissary, or assistant-commissary of musters, as the case may be, will countersign both enlistments as having mustered the soldier into the service of the United States before either of them is given to the disbursing officer.

DECLARATION OF RECRUIT.

I, *John Wilson* desiring to VOLUNTEER as a Soldier in the Army of the United States, for the term of THREE YEARS, Do Declare, That I am *twenty three* years and _____ months of age; that I have never been discharged from the United States service on account of disability or by sentence of a court-martial, or by order before the expiration of a term of enlistment; and I know of no impediment to my serving honestly and faithfully as a soldier for three years.

GIVEN at *Norfolk Va* the *23^d* day of *Novemb 1864*

Witness: *A. K. Starkweather* *John Wilson*
mark

Discharged _____ 18 _____
14th Reg't of N. Y. Cavalry

enlistment; last served in Company ()

By *A. M. Moore*
3^d Regiment of N. Y. I.

Volunteered at *Norfolk Va*
Novemb 26 1864

No. *33*

CONSENT IN CASE OF MINOR.

I, _____ Do CERTIFY, That I am _____ the _____ of _____; that the said _____ is _____ years of age; and I do hereby freely give my CONSENT to his volunteering as a SOLDIER in the ARMY OF THE UNITED STATES, for the period of THREE YEARS.

GIVEN at _____ the _____ day of _____

Wi _____

VOLUNTEER ENLISTMENT.

STATE OF

Mass



TOWN OF

1st Cong. Dist
At Large

I, John Wilson

born in

Petersburg

in the State of

Virginia

aged

twenty three years,

and by occupation a

laborer

DO HEREBY ACKNOWLEDGE to have

volunteered this twenty third day of November 1864,

to serve as a Soldier in the Army of the United States of America, for the period of THREE YEARS, unless sooner discharged by proper authority: Do also agree to accept such bounty, pay, rations, and clothing, as are, or may be, established by law for volunteers. And I, John Wilson do

solemnly swear that I will bear true faith and allegiance to the United States of America, and that I will serve them honestly and faithfully against all their enemies or opposers whomsoever; and that I will observe and obey the orders of the President of the United States, and the orders of the officers appointed over me, according to the Rules and Articles of War.

Sworn and subscribed to, at

Newport News

on this

26th

day of

Nov

1864

John Wilson
mark

BEFORE

M. Mowbray
Lt. 37th U.S.C.T.

I CERTIFY, ON HONOR, That I have carefully examined the above-named Volunteer, agreeably to the General Regulations of the Army, and that, in my opinion, he is free from all bodily defects and mental infirmity, which would in any way disqualify him from performing the duties of a soldier.

W.C. Gray
Asst Surg. Major

EXAMINING SURGEON.

I CERTIFY, ON HONOR, That I have minutely inspected the Volunteer, Wilson previously to his enlistment, and that he was entirely sober when enlisted; that, to the best of my judgment and belief, he is of lawful age; and that, in accepting him as duly qualified to perform the duties of an able-bodied soldier, I have strictly observed the Regulations which govern the recruiting service.

This soldier has brown eyes, black hair, fair complexion, is five feet six inches high.

James M. Mowbray
Lt. 37th Regiment of U.S.C.T.

RECRUITING OFFICER.

Mustered into the service of the United States, in Company
the 26th day of November, 1864, at Newport News Va
1st Regt of Va Volunteers, on
the 26th day of Nov 1864
at Newport News Va
John Wilson
M. Mowbray
W.C. Gray
James M. Mowbray
Asst Surg. Major

James Wilson

Co. 1st Regt. S. C.

His of record etc

----- 1863,

✓

General Order No. 19. Hd. Qrs. Dist. of Eastern
Virginia March 30-1865.

g. Private John Wilson. Co. "D." 1st U.S. C. Cav.
Charge 1st Desertion

" 2nd Obtaining money under false pretences
Findings "Guilty."

Sentence: "That he refund to Private
Smith, Co. "D." 1st U.S. Cold. Cav. the sum
of \$80. fraudulently obtained, and that
he be confined at hard labor at such
place as the Com. Genl. may direct for
the remainder of his term of enlistment
and forfeit all pay and allowances now
due or to become due - except the just
dues of the sutler & Launderer and
that he be dishonorably discharged
the service at the expiration of his
term of enlistment.

Approved

By order Brig. Gen. Geo. H. Gordon

1491 or news
Wilson, Louis

Co *F*, 1 U. S. Col'd Cav.

Private

Private

CARD NUMBERS.

- 1 5307949
- 2 5308018
- 3 5308100
- 4 5308185
- 5 5308275
- 6 5300456
- 7 5308361
- 8 5308448
- 9 5308545
- 10 5308654
- 11 5308762
- 12 5308868
- 13 5308971
- 14 5309077
- 15 5309170
- 16 5309266
- 17 9086849
- 18 40725492
- 19 34354856
- 20 40725503
- 21
- 22
- 23
- 24
- 25

- 26
- 27
- 28
- 29
- 30
- 31
- 32
- 33
- 34
- 35
- 36
- 37
- 38
- 39
- 40
- 41
- 42
- 43
- 44
- 45
- 46
- 47
- 48
- 49
- 50

Book Mark: *4825 P.M.G. May 28/66.*

See also

N. | 1 Cav. | U.S.C.T.

Louis Wilson

....., Co. F, 1 Reg't U.S. Col'd Cav.

Appears on

Company Descriptive Book

of the organization named above.

DESCRIPTION.

Age 25 years; height 6 feet 7 inches.

Complexion Black

Eyes; Black hair Wavy

Where born Norfolk Va.

Occupation Serv.

ENLISTMENT.

When Dec 7-63

Where Norfolk

By whom Capt Brown; term 3 y'rs.

Remarks:

.....

.....

.....

.....

.....

.....

.....

.....

.....

.....

.....

.....

.....

.....

.....

.....

.....

.....

.....

.....

.....

.....

.....

.....

.....

.....

.....

.....

.....

.....

.....

.....

.....

.....

.....

.....

.....

.....

.....

.....

.....

.....

.....

.....

.....

.....

Dickerson

N | **1 Cav.** | **U.S.C.T.**

Louis Wilson

Pvt, Co. *F*, 1 Reg't U. S. Col'd Cavalry.

Age *25* years.

Appears on

Company Muster-in Roll

of the organization named above. Roll dated
Camp Hamilton Va Dec. 22, 1863.

Muster-in to date *Dec. 22, 1863.*

Joined for duty and enrolled:

When *Dec. 7*, 1863.

Where *Norfolk, Va.*

Period *3* years.

Valuation of horse, \$ 100

Valuation of horse equipments, \$ 100

Remarks:

Book mark:

(356)

Perry

Copyist.

A | **1 Cav.** | **U.S.C.T.**

Louis Wilson

Qui, Co. F, 1 Reg't U. S. Col'd Cavalry.

Appears on

Company Muster Roll

for *22 Dec to 31 Dec*, 1863.

Present or absent *Present*

Stoppage, \$ *100* for

Due Gov't, \$ *100* for

Valuation of horse, \$ *100*

Valuation of horse equipments, \$ *100*

Remarks:

Book mark:

Curry

(358)

Copyist.

A. | **1 Cav.** | **U.S.C.T.**

Louis Wilson

Pvt., Co. F, 1 Reg't U. S. Col'd Cavalry.

Appears on

Company Muster Roll

for *Jan & Feb*, 1864.

Present or absent *Present*

Stoppage, \$ *100* for

Due Gov't, \$ *100* for

Valuation of horse, \$ *100*

Valuation of horse equipments, \$ *100*

Remarks:

Book mark:

(358)

Perry

Copyist.

A | 1 Cav. | U.S.C.T.

Lewis Wilson

Pvt, Co. F, 1 Reg't U. S. Col'd Cavalry.

Appears on

Company Muster Roll

for *Mch & Apr*, 1864.

Present or absent *Present*

Stoppage, \$ *100* for

Due Gov't, \$ *100* for

Valuation of horse, \$ *100*

Valuation of horse equipments, \$ *100*

Remarks:

Book mark:

Perry

(358)

Copyist.

W 1 Cav. WDCY

Louis Wilson

Pat 1 Regt U.S. Cold Cav.

Appears on

Muster Roll

of Enlisted Men, Ambulance Corps, 1 Division,
18 Army Corps,

for *May & June*, 1864.

Station *In the Field*

Clothing account:

Last settled....., 186 ; drawn since \$..... 100

Present or absent *Present*

Remarks: *Detained to
Amb. Corps*

Book mark: _____

Ragan

W | 1 Cav. | U.S.C.T.

Lewis Wilson

Priv, Co. F, 1 Reg't U. S. Col'd Cavalry.

Appears on

Company Muster Roll

for *May & June*, 1864.

Present or absent *Absent*

Stoppage, \$ *100* for

Due Gov't, \$ *100* for

Valuation of horse, \$ *100*

Valuation of horse equipments, \$ *100*

Remarks: *On D.S per S.O
Hd. Qrs. 1st U.S.C.C.
June 29, 1864*

Book mark:

Cerry Copyist.

(358)

W | 1 Cav. | **U.S.C.T.**

Louis Wilson

Pvt., Co. F, 1 Reg't U. S. Col'd Cavalry

Appears on a

Detachment Muster Roll

of the organization named above

for Dated June 30, 1864.

Station In the Field

Present or absent Present

Stoppage, \$ 100 for

Due Gov't, \$ 100 for

Valuation of horse, \$ 100

Valuation of horse equipments, \$ 100

Remarks:

Book mark:

Wanner

(341)

Copyist.

A

1 Cav. U.S.C.T.

Lewis Wilson

Priv, Co. F, 1 Reg't U. S. Col'd Cavalry.

Appears on

Company Muster Roll

for *July & Aug*, 1864.

Present or absent *Present*

Stoppage, \$ *100* for

Due Gov't, \$ *100* for

Valuation of horse, \$ *100*

Valuation of horse equipments, \$ *100*

Remarks:

Book mark:

(358)

Perry

Copyist.

W | **1 Cav.** | **U.S.C.T.**

Lewis Wilson

Qm, Co. F, 1 Reg't U. S. Col'd Cavalry.

Appears on

Company Muster Roll

for *Sept 10th*, 1864.

Present or absent *Present*

Stoppage, \$ 100 for

Due Gov't, \$ 100 for

Valuation of horse, \$ 100

Valuation of horse equipments, \$ 100

Remarks:

Book mark:

(358)

J. M. Leonard
Copyist.

26 | 1 Cav. | U.S.C.T.

Lewis Wilson

Private, Co. F, 1 Reg't U. S. Col'd Cavalry.

Appears on

Company Muster Roll

for Nov. & Dec, 1864.

Present or absent Present

Stoppage, \$ 100 for

Due Gov't, \$ 100 for

Valuation of horse, \$ 100

Valuation of horse equipments, \$ 100

Remarks:

Book mark:

[Signature]

(358)

Copyist.

W | 1 Cav. | U.S.C.T.

Lewis Wilson

Priv, Co. F, 1 Reg't U. S. Col'd Cavalry.

Appears on

Company Muster Roll

for *Jan & Feb*, 1865.

Present or absent *Present*

Stoppage, \$ *100* for

Due Gov't, \$ *100* for

Valuation of horse, \$ *100*

Valuation of horse equipments, \$ *100*

Remarks:

Book mark:

J. W. Leonard

(358)

Copyist.

24 | 1 Cav. | U.S.C.T.

Lewis Wilson

Priv., Co. F, 1 Reg't U. S. Col'd Cavalry.

Appears on

Company Muster Roll

for Mar. & Apr., 1865.

Present or absent Present

Stoppage, \$ 100 for

Due Gov't, \$ 100 for

Valuation of horse, \$ 100

Valuation of horse equipments, \$ 100

Remarks:

Book mark:

(358)

J. M. Leonard

Copyist.

W | **1 Cav.** | **U.S.C.T.**

Lewis Wilson

Pw, Co. F, 1 Reg't U. S. Col'd Cavalry.

Appears on

Company Muster Roll

for *May June*, 1865.

Present or absent *Present*

Stoppage, \$ *100* for

Due Gov't, \$ *100* for

Valuation of horse, \$ *100*

Valuation of horse equipments, \$ *100*

Remarks: *Due U.S. Branch
31 ct.*

Book mark:

J. Leonard

(358)

Copyist.

24

1 Cav.

U.S.C.T.

Lewis Wilson

Private

, Co. F, 1 Reg't U. S. Col'd Cavalry.

Appears on

Company Muster Roll

for July & Aug, 1865.

Present or absent Present

Stoppage, \$ 100 for

Due Gov't, \$ 100 for

Valuation of horse, \$ 100

Valuation of horse equipments, \$ 100

Remarks: due U.S. for Ordnance Branch 31 cts.

Book mark:

J. L. Leonard

(358)

Copyist.

No. | 1 Cav. | U.S.C.T.

Lewis Wilson
Cvt., Co. F, 1 Reg't U. S. Col'd Cavalry.

Appears on

Company Muster Roll

for Sept + Oct., 1865.

Present or absent Present.

Stoppage, \$ 100 for

Due Gov't, \$ 100 for

Valuation of horse, \$ 100

Valuation of horse equipments, \$ 100

Remarks:

Book mark:

A. J. Cooke

(358)

Copyist.

W. | 1 Cav. | U.S.C.T.

Lewis Wilson

Co. F, Co. F, 1 Reg't U. S. Col'd Cavalry.

Appears on

Company Muster Roll

for *Nov. Aug Dec*, 186*5*.

Present or absent *Present*

Stoppage, \$ *100* for

Due Gov't, \$ *100* for

Valuation of horse, \$ *100*

Valuation of horse equipments, \$ *100*

Remarks:

Book mark: _____

B. J. Cooke

(358)

Copyist.

W

1 Cav. U.S.C.T.

Wilson 3d

Pr, Co. *F*, 1 Reg't U. S. Colored Cav.

Appears on Returns as follows:

June 1864 absence on
D.S. for S.O. Hayes. 1 week.
June 26

Book mark:

W. D. Miller

(546)

Copyist.

W | 1 Cav. | U. S. C. T.

Lewis Wilson

Bth, Co. *F*, 1 Reg't U. S. Col'd Cav.

Appears on Returns as follows:

*June 1864 Absent on DS.
pr S. O. Hdqrs 1 USCC.
June 26*

*Sept Oct & Dec 1865 On duty
Co Cook*

Book mark :

Scottell

W. | **1 Cav.** | **U.S.C.T.**

Lewis Wilson
Priv, Co. *F*, 1 Reg't U. S. Col'd Cavalry.

Appears on **Co. Muster-out Roll**, dated

Pragos Santiago Tex, Feb. 4, 1866.

Muster-out to date *Feb. 4, 1866.*

Last paid to *Aug. 31, 1865.*

Clothing account:

Last settled _____, 186 ; drawn since \$ _____ 100

Due soldier \$ *18/0* / 100; due U. S. \$ _____ 100

Am't for cloth'g in kind or money adv'd \$ _____ 100

Due U. S. for arms, equipments, &c., \$ _____ 100

Bounty paid \$ *None* 100; due \$ *None* 100

Remarks: *Joined at Oriskany.*

Book mark *4825 C.M. May 28/66 C.H.*

(861)

B. J. Cooke

Copyist.

Wilson, Moses

Co C, 1 U. S. Col'd Cav.

Private

Private

CARD NUMBERS.

1	5303858	26
2	5303930	27
3	5304020	28
4	5304101	29
5	5304186	30
6	5300398	31
7	5304272	32
8	5304358	33
9	5304462	34
10	5304572	35
11	5304678	36
12	5304777	37
13	5304877	38
14	5304971	39
15	5305061	40
16	5305749	41
17	9086003	42
18	34354796	43
19		44
20		45
21		46
22		47
23		48
24		49
25		50

Book Mark:

See also

N | **1 Cav. | U.S.C.T.**

Moses Wilson

....., Co. *C*, 1 Reg't U.S. Col'd Cav.

Appears on

Company Descriptive Book

of the organization named above.

DESCRIPTION.

Age *20* years; height *5* feet *3/4* inches.

Complexion *Black*

Eyes; *Black* hair *Black*

Where born *Princeton, Va*

Occupation *Furrier*

ENLISTMENT.

When *Dec 4 '63*

Where *Norfolk Va*

By whom *Capt Brown*; term *3* y'rs.

Remarks:

.....
.....
.....
.....
.....
.....
.....
.....
.....
.....

Heuser

M. | *1 Cav.* | **U.S.C.T.**

Mason Wilson

A., Co. *C*, 1 Reg't U. S. Col'd *Cav.*

Age *19* years.

Appears on

Company Muster-in Roll

of the organization named above. Roll dated

Ch. Hamilton, Va., Dec. 22, 1863.

Muster-in to date *Dec. 22, 1863.*

Joined for duty and enrolled:

When *Dec. 4*, 1863.

Where *Winchester, Va.*

Period *3* years.

Valuation of horse, \$ *100*

Valuation of horse equipments, \$ *100*

Remarks :

Book mark :

Steel

(356)

Copyist.

W

1 Cav.

U.S.C.T.

Moses Wilson

Plt

, Co. C, 1 Reg't U. S. Col'd Cavalry.

Appears on

Company Muster Roll

for *Dec 22 to 31*, 1863.

Present or absent *Present*

Stoppage, \$ *100* for

Due Gov't, \$ *100* for

Valuation of horse, \$ *100*

Valuation of horse equipments, \$ *100*

Remarks:

Book mark:

Ackerman

(358)

Copyist.

W | 1 Cav. | U.S.C.T.

Moses Willson

Plt, Co. C, 1 Reg't U. S. Col'd Cavalry.

Appears on

Company Muster Roll

for *Jan'y + Feb*, 1864

Present or absent *Present*

Stoppage, \$ *100* for

Due Gov't, \$ *100* for

Valuation of horse, \$ *100*

Valuation of horse equipments, \$ *100*

Remarks:

Book mark: -----

Acterman

N | 1 Cav. | U.S.C.T.

Moses Nilson

Pvt, Co. C, 1 Reg't U. S. Col'd Cavalry.

Appears on

Company Muster Roll

for *Mar + Apr*, 1864.

Present or absent *Absent*

Stoppage, \$ *100* for

Due Gov't, \$ *100* for

Valuation of horse, \$ *100*

Valuation of horse equipments, \$ *100*

Remarks: *Absent at Camp Dix Va.*

Book mark:

A. Kernan

(358)

Copyist.

W. V. Cav. US 65

Moses Wilson

Pat 1 Regt W. S. Cald Cav

Appears on

Muster Roll

of Enlisted Men, Ambulance Corps, 1 Division,
18 Army Corps,

for *May & June*, 186*4*.

Station *In the Field*

Clothing account:

Last settled....., 186 ; drawn since \$..... 100

Present or absent *Present*

Remarks: *Detached to
Amb. Corps,*

& Col. James M. Moore

Book mark:

Ragan

(520)

Copyist

N

1 Cav.

U.S.C.T.

Moses Wilson

Plt, Co. C, 1 Reg't U. S. Col'd Cavalry.

Appears on

Company Muster Roll

for *May + June*, 1864.

Present or absent *Absent*

Stoppage, \$ *100* for

Due Gov't, \$ *100* for

Valuation of horse, \$ *100*

Valuation of horse equipments, \$ *100*

Remarks: *Absent on detached Service Order from Hd Qrs 1st U.S.C. dated June 26/64*

Book mark:

A. Kerman

(358)

Copyist.

lv | 1 car | U.S.C.T.

Moses Wilson

Pvt, Co. W, 1 Reg't U. S. Col'd Cavalry

Appears on a

Detachment Muster Roll

of the organization named above

for Dated June 30, 1864.

Station In the Field

Present or absent Present

Stoppage, \$ 100 for

Due Gov't, \$ 100 for

Valuation of horse, \$ 100

Valuation of horse equipments, \$ 100

Remarks:

Book mark:

Hammer

(344)

Copyist.

W | **1 Cav.** | **U.S.C.T.**

Moses Wilson

Pat, Co. C, 1 Reg't U. S. Col'd Cavalry.

Appears on

Company Muster Roll

for *July & Aug*, 186*4*.

Present or absent *Present*

Stoppage, \$ *100* for

Due Gov't, \$ *100* for

Valuation of horse, \$ *100*

Valuation of horse equipments, \$ *100*

Remarks:

Book mark:

A. Kerman

(358)

Copyist.

W | 1 Cav. | U.S.C.T.

Mass Wilson

Pop, Co. C, 1 Reg't U. S. Col'd Cavalry.

Appears on

Company Muster Roll

for *Sept and Oct*, 186*1*.

Present or absent *Present*

Stoppage, \$ 100 for _____

Due Gov't, \$ 100 for _____

Valuation of horse, \$ 100

Valuation of horse equipments, \$ 100

Remarks: _____

Book mark: _____

(358) *J. M. ...* Copyist.

No. | 1 Cav. | U.S.C.T.

Moses Wilson

Pr4, Co. C, 1 Reg't U. S. Col'd Cavalry.

Appears on

Company Muster Roll

for Nov. & Dec., 1864.

Present or absent Present

Stoppage, \$ 100 for

Due Gov't, \$ 100 for

Valuation of horse, \$ 100

Valuation of horse equipments, \$ 100

Remarks:

Book mark: 1

(358)

J. M. Hance

Copyist.

M. | 1 Cav. | U.S.C.T.

Moses Wilson

Private, Co. C, 1 Reg't U. S. Col'd Cavalry.

Appears on

Company Muster Roll

for *Jan & Feb*, 1865.

Present or absent *Present*

Stoppage, \$ *100* for

Due Gov't, \$ *100* for

Valuation of horse, \$ *100*

Valuation of horse equipments, \$ *100*

Remarks:

.....
.....
.....
.....
.....
.....
.....
.....
.....
.....

Book mark:

J. M. Hance

(358)

Copyist.

N | **1 Cav.** | **U.S.C.T.**

Moses Wilson

Priv, Co. C, 1 Reg't U. S. Col'd Cavalry.

Appears on

Company Muster Roll

for *Mar & Apr*, 186*3*.

Present or absent *Present*

Stoppage, \$ *100* for

Due Gov't, \$ *100* for

Valuation of horse, \$ *100*

Valuation of horse equipments, \$ *100*

Remarks:

Book mark:

(358)

J. M. Hance

Copyist.

N. | 1 Cav. | U.S.C.T.

Moses Wilson

Priv., Co. C, 1 Reg't U. S. Col'd Cavalry.

Appears on

Company Muster Roll

for *May & June*, 1865.

Present or absent *Present*

Stoppage, \$ *100* for

Due Gov't, \$ *100* for

Valuation of horse, \$ *100*

Valuation of horse equipments, \$ *100*

Remarks:

Book mark:

(358) *J. M. Vance* Copyist.

W | **1 Cav. | U.S.C.T.**

Moses Wilson

Pat, Co. C, 1 Reg't U. S. Col'd Cavalry.

Appears on

Company Muster Roll

for *July & Aug.*, 1865.

Present or absent *Present.*

Stoppage, \$ 100 for

Due Gov't, \$ 100 for

Valuation of horse, \$ 100

Valuation of horse equipments, \$ 100

+ Remarks: *Mustered on June Muster Roll as Thomas Mack*

Remarks cancelled by lines.

Book mark:

(358)

J. M. Hance

Copyist.

H | **1 Cav. | U.S.C.T.**

Moses Wilson
Privt, Co. C, 1 Reg't U. S. Col'd Cavalry.

Appears on

Company Muster Roll

for *Sept 7 Oct*, 186*5*.

Present or absent *Present*

Stoppage, \$ *100* for

Due Gov't, \$ *100* for

Valuation of horse, \$ *100*

Valuation of horse equipments, \$ *100*

Remarks:
Due H. Co. & G. Co. 90 cts

Book mark:

Sumner

(358)

Copyist.

M

1 Cav. U.S.C.T.

Moses Wilson

Private, Co. C, 1 Reg't U. S. Col'd Cavalry.

Appears on

Company Muster Roll

for *Nov Dec*, 1865.

Present or absent *Present*.

Stoppage, \$ *100* for

Due Gov't, \$ *70* for *Ordnance*

lost or destroyed

Valuation of horse, \$ *100*

Valuation of horse equipments, \$ *100*

Remarks:

*Due Wf. for C & G equipage
lost .70 cts.*

Book mark:

Sumner

(358)

Copyist.

W | 1 Cav. | U.S.C.T.

Moses Wilson

Priv, Co. *C*, 1 Reg't U. S. Col'd Cavalry.

Appears on **Co. Muster-out Roll**, dated

Bragas Santiago Tex, Feb 4, 1866.

Muster-out to date *Feb 4*, 1866.

Last paid to *Aug 31*, 1865.

Clothing account:

Last settled _____, 186 ; drawn since \$ _____ $\frac{100}{100}$

Due soldier \$ _____ $\frac{100}{100}$; due U. S. \$ *21* $\frac{32}{100}$

Am't for cloth'g in kind or money adv'd \$ _____ $\frac{100}{100}$

Due U. S. for arms, equipments, &c., \$ _____ / $\frac{60}{100}$

Bounty paid \$ *None* $\frac{100}{100}$; due \$ *None* $\frac{100}{100}$

Remarks: *I joined at Crigt Org,*
Stopped for Carbmi Brush
Whiper, Carbmi Cone wrench
Spare Carbmi Cone, Haversack
and canteen. lost.

Book mark : _____

Lucas

1940
Wilson, Paldo

Co E, 1 U. S. Col'd Cav.

Personal papers herein.

Private

Private

CARD NUMBERS.

1	5299668	26
2	5307176	27
3	5307283	28
4	5307884	29
5	9086266	30
6	40725505	31
7		32
8		33
9		34
10		35
11		36
12		37
13		38
14		39
15		40
16		41
17		42
18		43
19		44
20		45
21		46
22		47
23		48
24		49
25		50

Book Mark:

See also

W | 1 bar | U.S.C.T.

Paldo Wilson

, Co. E, 1 Reg't U. S. Col'd bar

Appears on

Company Descriptive Book

of the organization named above.

DESCRIPTION.

Age 18 years; height 5 feet 5 inches.

Complexion Blk

Eyes Blk; hair Blk

Where born Norfolk Co. Va.

Occupation Farmer

ENLISTMENT.

When Nov 5, 1864.

Where Newport News

By whom Lt. Monroe; term 3 y'rs.

Remarks: Killed in skirmish
in Surry Co. Va.
Jan'y 25/65

(383g)

Laffer

Copyist.
Camp

W | **1 Cav.** | **U.S.C.T.**

James Wilson

Appears with rank of *Sgt* on

Muster and Descriptive Roll of a Detachment of U. S. Vols. forwarded

for the 1 Reg't U. S. Col'd Cavalry. Roll dated

Newport News Va Nov 30 1864

Where born *York Co. Va*

Age *18* y'rs; occupation *Farmer*

When enlisted *Nov 5*, 1864.

Where enlisted *Newport News*

For what period enlisted *3* years.

Eyes *blk*; hair *blk*

Complexion *blk*; height *5 ft. 5 in.*

When mustered in *Nov. 5*, 1864.

Where mustered in *Newport News*

Bounty paid \$ *100* / *100*; due \$ *100* / *100*

Where credited *Come at large*

Company to which assigned

Remarks:

Book mark:

(339)

W
Copyist.

W | **1 Cav. | U.S.C.T.**

John Wilson

Plt., Co. E, 1 Reg't U. S. Col'd Cavalry.

Appears on

Company Muster Roll

for *Nov & Dec.*, 1864.

Joined for duty and enrolled :

When *Nov. 5*, 1864.*

Where *Newport News, Va.**

Period *3* years.*

Present or absent *Present.*

Stoppage, \$ *100* for

Due Gov't, \$ *100* for

Valuation of horse, \$ *100*

Valuation of horse equipments, \$ *100*

Remarks: *Pay due from
Government.*

* See enrollment on card from muster-in roll.

Book mark :

(358c)

Wagner

Copyist.

W | **1 Cav.** | **U.S.C.T.**

Paldo Wilson

Pvt., Co. E, 1 Reg't U. S. Col'd Cavalry.

Appears on

Company Muster Roll

for *Jan 7 Feb*, 1865.

Joined for duty and enrolled :

When *Nov. 5*, 1864.*

Where *Newport News, Va.* *

Period *3* years.*

Present or absent

Stoppage, \$ *100* for

Due Gov't, \$ *100* for

Valuation of horse, \$ *100*

Valuation of horse equipments, \$ *100*

Remarks: *Killed in skirmish with enemy Jan. 25/65. Pay due from enrollment. Rec'd \$100. U.S. Bounty.*

* ~~See~~ See enrollment on card from muster-in roll.

Book mark :

Wagoner

W | 1 Cav. | U.S.C.T.

Saido Wilson

Priv, Co. *E*, 1 Reg't U. S. Colored Cav.

Appears on Returns as follows:

Nov 18 64 *Nov 21 64*
Powhatan Va
Co from Recruitment Depot

Jan 18 65 *Jan 25 65*
Cabin Point Va
in engagement with
the enemy.

Book mark:

Saido Wilson

W | *1 Cav* | **U.S.C.T.**

Paldo Wilson

Pri, Co. *E*, *1* Reg't U. S. Col'd *Cav*

Appears on **Co. Muster-out Roll**, dated
Brazos Santiago Texas, *Feb. 4*, 1866.

Muster-out to date 186 .
Last paid to 186 .

Clothing account:

Last settled 186 ; drawn since \$ 100
Due soldier \$ 100 ; due U. S. \$ 100
Am't for cloth'g in kind or money adv'd \$ 100

Due U. S. for arms, equipments, &c., \$ 100
Bounty paid \$ 100 ; due \$ 100

Remarks: *Joined as recruit. Killed in battle in Leary Co Va Jan 25/65, final statements + inventory of effects forwarded Nov 25/65.*

Book mark :

(361)

A W Allen

Copyist.

Wilson, Baldo
Pvt. E, Co. *E*, Reg't *U.S.C. Cav.*

4 Enclosures.

Bed Cards	Descriptive Lists
Burial Records	Final Statements
Certs. of Dis. for Discharge	Furloughs
C. M. Charges	Med. Des. Lists
Med. Certificates	Orders

Other papers relating to—

Admission to Hosp'l	Furlough
Casualty Sheet (<i>Pvt.</i> <u>Officer's</u>)	Med. Examination
Confinement	Misc. Information
Contracts	Pay or Clothing
Death or Effects	Personal Reports
Desertions	Rank
Discharge from Hosp'l	Transfer to Hosp'l
Discharge from Service	Transfer to V. R. C.
Duty	Transportation

DECLARATION OF RECRUIT.

I, Paldo Wilson, desiring to VOLUNTEER as a Soldier in the Army of the United States, for the term of THREE YEARS, Do Declare, That I am Eighteen years and _____ months of age; that I have never been discharged from the United States service on account of disability or by sentence of a court martial, or by order before the expiration of a term of enlistment; and I know of no impediment to my serving honestly and faithfully as a soldier for three years.

GIVEN at Norfolk Virginia the 28 day of October 1864

Witness:

Joseph Selman

Paldo Wilson

No. 34
Paldo Wilson
66

Volunteered at Newport News

Nov 5 1864

By J. M. Moore

37 Regiment of VA

enlistment; last served in Company ()

1st Regt of VA Cavalry

Discharged _____, 1864

CONSENT IN CASE OF MINOR.

I, _____, Do CERTIFY, That I am the _____ of _____; that the said _____ is _____ years of age; and I do hereby freely give my CONSENT to his volunteering as a SOLDIER in the ARMY OF THE UNITED STATES for the period of THREE YEARS.

GIVEN at _____ the _____ day of _____

Witness:

NOTE 1.—This book will be used for both enlistments and reenlistments—enlistments of recruits, &c. &c. in the volunteer service. They will be made out in duplicate in all cases—one to accompany the returning return of the superintendent and the returning officer, to the Adjutant General, and one to accompany the accounts of the officers who pay bounty, &c. The Regiment and Company in which the soldier last served shall be given in the book.

NOTE 2.—An enlistment book is to be used in all cases, previous payment of pay, bounty, pension, &c. A muster-in roll must, in all cases, be used in the Adjutant General's Office as evidence of muster-in. The muster-in roll, commissary, or assistant commissary of musters, as the case may be, will countersign both enlistments as having mustered the soldier into the service of the United States before either of them is given to the disbursing officer.

VOLUNTEER ENLISTMENT.

STATE OF

TOWN OF

Connecticut



at Ledge

I, *Paldo Wilson*, born in *Newport* in the State of *Virginia*, aged *Twenty* years, and by occupation a *Farmer*. Do HEREBY ACKNOWLEDGE to have volunteered this *Twenty Eighth* day of *October*, 1864, to serve as a **Soldier** in the **Army of the United States of America**, for the period of **THREE YEARS**, unless sooner discharged by proper authority: Do also agree to accept such bounty, pay, rations, and clothing, as are, or may be, established by law for volunteers. And I, *Paldo Wilson*, do solemnly swear, that I will bear true faith and allegiance to the **United States of America**, and that I will serve them honestly and faithfully against all their enemies or opposers whomsoever; and that I will observe and obey the orders of the President of the United States, and the orders of the officers appointed over me, according to the Rules and Articles of War.

Sworn and subscribed to, at *Newport News* on this *5th* day of *Nov*, 1864, by *Paldo Wilson* his *mark* BEFORE *J. M. Monroe* Lt. 37th U.S.C.T.

I CERTIFY, ON HONOR, That I have carefully examined the above-named Volunteer, agreeably to the General Regulations of the Army, and that, in my opinion, he is free from all bodily defects and mental infirmity, which would in any way disqualify him from performing the duties of a soldier.

W. H. Gray
Assistant Surg. U.S.A.
EXAMINING SURGEON.

I CERTIFY, ON HONOR, That I have minutely inspected the Volunteer *P. Wilson* previously to his enlistment, and that he was entirely sober when enlisted; that, to the best of my judgment and belief, he is of lawful age; and that, in accepting him as duly qualified to perform the duties of an able-bodied soldier, I have strictly observed the Regulations which govern the recruiting service. This soldier has *Blk* eyes, *Blk* hair, *Blk* complexion, is *Five* feet *five* inches high.

James M. Monroe
Lt. 37th Regiment of U.S.C.T.
RECRUITING OFFICER.

(A. G. O. No. 74 & 75.)

Mustered into the service of the United States, for three years or during the war, from date of enlistment, in Company _____
 1st Regiment of *Volunteers*, on the *5th* day of *November*, 1864, at *Newport News*
 Paldo Wilson
 Company 1st Regt U.S.C.T.

INVENTORY OF THE EFFECTS

OF

*Private Paldo Wilson*Late of Company *"E"**First* Reg't of *W. S. C. Cav.*

Volunteers, who ~~died at~~ *was killed in a*
skirmish with the enemy
on the *25* day of *January* 1865.



Inventory of the effects of Baldo Wilson late
a Private of Captain C. W. Emersons Company "E" of
the First Regiment of U.S. Colored Cavalry Volunteers, who was enrolled as
a Private at Newport News in the State of Virginia on
the 5th day of November 1864, and mustered into the service of the United
States as a Private on the 5th day of November 1864, at Newport News
in Company "E", First Regiment of U.S.C. Cavalry Volunteers, to serve Three (3)
years or during the war; he was born in _____ in the State
of _____; he was _____ years of age, _____ feet _____ inches
high, _____ complexion, _____ eyes, _____ hair, and by occupation, when enrolled,
a _____; he died in Was killed in skirmish, at
With Enemy on the 25th day of January 1865, by
reason of Being shot by the enemy

No		INVENTORY.		Effects	
ARTICLES.	No.	ARTICLES.	No.	ARTICLES.	No.
Hats.....		Pairs trousers.....		Knapsacks.....	
Caps.....		Pairs flannel drawers.....			
Forage caps.....		Pairs cotton drawers.....			
Great coats.....		Flannel shirts.....			
Uniform coats.....		Cotton shirts.....			
Uniform jackets.....		Pairs boots.....			
Flannel sack coats.....		Pairs shoes.....			
Blouses.....		Pairs socks.....			
Stable frocks.....		Blankets.....			
Fatigue overalls.....		Haversacks.....			
				MONEY.	
				Specie.....	\$
				Notes.....	\$

I CERTIFY, ON HONOR, that the above inventory comprises all the effects of Private
Baldo Wilson, deceased, and that the effects are in the hand
of Records of this Company at _____
_____ to be disposed of by a Council of Administration.

(DUPLICATES.)

STATION: Brayos Santiago Texas

DATE: Nov 21st 1865

Eugene Sullivan
2nd Lt. 1st U.S.C. Cav.
Commanding the Company.

CASUALTY SHEET

Completed
 No.

Paulo Wilson

Priv of Company E

1st Regiment of W.C.C.

State Volunteers.

NATURE OF CASUALTY.

Died June 25th / 65

CASUALTY SHEET.

Name: Fred Wilson
 Rank: Priv Company: E. Regiment: 1st
 Arm: U.S. Cavalry State: _____
 Nature of Casualty: Death.

CAUSE OF CASUALTY—(NAME OF DISEASE, &c.)
Being shot by the enemy

DEGREE OF DISABILITY.

BY WHOM CERTIFIED.
Eugene Sullivan
S. Lt. 1st U.S.C.

DATE OF DISCHARGE, DEATH, &c.
Jan'y 25. 1865

PLACE OF DISCHARGE, DEATH, &c.

BY WHOM DISCHARGED.

FROM WHAT SOURCE THIS INFORMATION WAS OBTAINED.
Inv of effects

REMARKS.
U.S. Oct. 20. 1864
Inv of effects sent
2. Auditors

B.F.C
 Clerk.

Ft. Ds. 1st U.S. C. Cavalry
 Brazos Santiago Texas
 November 21st 1865

Sir

I have the honor to forward herewith
 Inventory of effects and Final Statements of Private
 Paldo Wilson Co. "E" 1st U.S. Colored Cavalry who
 was killed in a skirmish with the enemy January
 25th 1865.

I assumed temporary Command of this Co. the 1st inst.
 and find no description of the deceased soldier in the
 Books of the Company, except what is stated in the Muster
 Roll for the Months of January and February 1865.

Very Respectfully Yours Obedt. Servant
 Eugene Sullivan
 2nd Lt. Co. "E" 1st U.S. C. Cav.

L. Thomas
 Adjutant Gen. U.S. A.
 Washington D. C.

1494
 Wilson, Palen

Co B, 1 U. S. Col'd Cav.

Private

Private

CARD NUMBERS.

1	5299361	26
2	5302629	27
3	5302715	28
4	5302802	29
5	5300264	30
6	5302887	31
7	5302973	32
8	5303070	33
9	5300185	34
10	5303289	35
11	5303401	36
12	5300766	37
13	5303800	38
14	9083-935	39
15	34355208	40
16	40725504	41
17		42
18		43
19		44
20		45
21		46
22		47
23		48
24		49
25		50

Book Mark: _____

See also _____

A | **1 Cav. | U.S.C.T.**

Calvin Wilson

....., Co. *B*, 1 Reg't U.S. Col'd Cav.

Appears on

Company Descriptive Book

of the organization named above.

DESCRIPTION.

Age *21* years; height *5* feet *7* inches.

Complexion *Dark*

Eyes; *Black* hair *Black*

Where born *Paspatsunk Co Va*

Occupation *Laborer*

ENLISTMENT.

When *Jan 20" 1864*

Where *Norfolk Va*

By whom *Lt Hudson*, term *3* y'rs.

Remarks: *Discharged*

Jan 15" 1865 Ft.

Mansory Va

Harrison

W | 1 Cav. | U.S.C.T.

Salen Wilson

Appears with rank of *Priv* on

Muster and Descriptive Roll of a Detachment of U. S. Vols. forwarded

for the 1 Reg't U. S. Col'd Cavalry. Roll dated

Camp Hamilton Va. Feby 22, 1864.

Where born *Paspatent Co. Va.*

Age *21* y'rs; occupation *Laborer*

When enlisted *Jan 20*, 1864.

Where enlisted *Norfolk Va.*

For what period enlisted *3* years.

Eyes *Blk*; hair *Blk*

Complexion *Blk*; height *5 ft. 7 in.*

When mustered in *Feby 22*, 1864.

Where mustered in *F. H. Morrow*

Bounty paid \$ *100*; due \$ *100*

Where credited

Company to which assigned

Remarks:

Book mark:

J. H. Morris

M | 1 Cav. | U.S.C.T.

Calvin Miller

C. M., Co. B, 1 Reg't U. S. Col'd Cavalry.

Appears on

Company Muster Roll

for *Jan 1st* *Feb*, 186*2*.

Present or absent *Present*

Stoppage, \$ *100* for

Due Gov't, \$ *100* for

Valuation of horse, \$ *100*

Valuation of horse equipments, \$ *100*

Remarks: *Pay due since*
Jan 21st '62

Book mark:

J. A. Miller
Copyist.

11 | 1 Cav. | U.S.C.T.

Robert Miles
Co. B, 1 Reg't U. S. Col'd Cavalry.

Appears on

Company Muster Roll

for *William J. Miller*, 1864.

Present or absent *Present*

Stoppage, \$ *100* for

Due Gov't, \$ *100* for

Valuation of horse, \$ *100*

Valuation of horse equipments, \$ *100*

Remarks:

Book mark: -----

J. M. [Signature]
(358) Copyist.

21 | 1 Cav. | U.S.C.T.

Palen Wilson
Pvt., Co. B, 1 Reg't U. S. Col'd Cavalry.

Appears on

Company Muster Roll

for *May 1st*, 186*4*.

Present or absent *Absent*

Stoppage, \$ 100 for

Due Gov't, \$ 100 for

Valuation of horse, \$ 100

Valuation of horse equipments, \$ 100

Remarks: *On detach. serv.
Spec. order Hd Qrs.
1st U.S. Cav. June 26 64
Due to horse
equip. lost 0.52*

Book mark:

Wilson
Copyist.

W V Cav. W.S.C.I

Palan Wilson

Priv. 1 Regt U.S. Cold Cav.

Appears on

Muster Roll

of Enlisted Men, Ambulance Corps, 2 Division,
18 Army Corps,

for May + June 1864.

Station In the Field, Va

Clothing account:

Last settled _____, 186; drawn since \$ 100

Present or absent Present

Remarks Gives U.S.

for Skins and
straps 52
cents -

Book mark:

Pagan

(520)

Copyist.

W | 1 Cav. | U.S.C.T.

Calam Wilson

Svt, Co., 1 Reg't U. S. Col'd Cavalry

Appears on a

Detachment Muster Roll

of the organization named above

for May & June, 1864

Station In the field Va. near Petersburg

Present or absent Present

Stoppage, \$ 100 for

Due Gov't, \$ 100 for

Valuation of horse, \$ 100

Valuation of horse equipments, \$ 100

Remarks: Owe U.S. for Spurs & Straps \$0.52

Book mark :

Hammer

(344)

Copyist.

W | **1 Cav.** | **U.S.C.T.**

Patron Wilson
1st., Co. B, 1 Reg't U. S. Col'd Cavalry.

Appears on

Company Muster Roll
for *Jul. 1st*, 186*4*.

Present or absent *Present*

Stoppage, \$ 100 for

Due Gov't, \$ 100 for

Valuation of horse, \$ 100

Valuation of horse equipments, \$ 100

Remarks *Deerly horse*
with lost 1.52

Book mark:

Hartway
(358) Copyist.

N | 1 Cav. | U.S.C.T.

Palmer Wilson

O, Co. B, 1 Reg't U. S. Col'd Cavalry.

Appears on

Company Muster Roll

for *Sept. + Oct.*, 1864.

Present or absent *Present*

Stoppage, \$ *100* for

Due Gov't, \$ *100* for

Valuation of horse, \$ *100*

Valuation of horse equipments, \$ *100*

Remarks:

Book mark:

(358)

Shadlock

Copyist.

W | **1 Cav.** | **U.S.C.T.**

Palen Wilson

P, Co. B, 1 Reg't U. S. Col'd Cavalry.

Appears on

Company Muster Roll

for *Nov. + Dec.*, 1864.

Present or absent *Absent*

Stoppage, \$ *100* for

Due Gov't, \$ *100* for

Valuation of horse, \$ *100*

Valuation of horse equipments, \$ *100*

Remarks: *On guard.*

Book mark:

(358)

Shadwell

Copyist.

W. | **1 Cav.** | **U.S.C.T.**

Palen Wilson

P, Co. B, 1 Reg't U. S. Col'd Cavalry.

Appears on

Company Muster Roll

for *Jan. & Feb.*, 1865.

Present or absent *Present*

Stoppage, \$ *100* for

Due Gov't, \$ *100* for

Valuation of horse, \$ *100*

Valuation of horse equipments, \$ *100*

Remarks: *Due U.S. Col'd Cavalry.*
Equip. 45¢

Book mark:

(358)

Shadwell

Copyist.

24 | 1 Cav. | U.S.C.T.

Palmer Wilson

P, Co. B, 1 Reg't U. S. Col'd Cavalry.

Appears on

Company Muster Roll

for Mar. & Apr., 1865

Present or absent Present

Stoppage, \$ 100 for

Due Gov't, \$ 100 for

Valuation of horse, \$ 100

Valuation of horse equipments, \$ 100

Remarks: Due U.S. Camp & Garrison Equip. 45⁰⁰ for Ordnance, \$ 20⁰⁰

Book mark: _____

(358)

Shadlock

Copyist.

N | 1 Cav. | U.S.C.T.

Palen Wilson

P, Co. B, 1 Reg't U.S. Col'd Cavalry.

Appears on

Company Muster Roll

for *May & June*, 186*5*.

Present or absent

Stoppage, \$ *100* for

Due Gov't, \$ *100* for

Valuation of horse, \$ *100*

Valuation of horse equipments, \$ *100*

Remarks: *Deserted June 15/65*
Fort Monroe Va. Dec 11.
Camps. Garrison Equip 6⁵⁰
Ordnance 2⁹⁶ Clothing 9⁶¹

Book mark:

(358)

Shadbolt

Copyist.

M | *1 Cav.* | **U.S.C.T.**

Palen Wilson

priv., Co. *B*, *1* Reg't U. S. Col'd *Cav.*

Appears on

Descriptive List of Deserters

dated *Brazos Santiago Tex. June 30*, 1865.

Deserted :

When *June 13*, 1865.

Where *Fort Monroe*

Arrested :

When _____, 186 .

Where _____

Remarks : *Blue U.S. C & G. equip. 1/2 Shells*
Tent - Canvas Haversack #620. Spivance
Colts Rev. Brush. Thong & rod. Carbine wrench
Sabre belt & plate, cap pouch & pick, Carbine
Car. Box. Car sling & rivet screw
Trim & cone wrench #25-26

Book mark : _____

Somers

(351)

Copyist.

W | 1 Cav. | U.S.C.T.

* Salem Wilson

Priv., Co. B, 1 Reg't U. S. Colored Cav.

Appears on Returns as follows:

May 1864 York

Enlisted in Regt

May 1864 absent at
Camp. Mich Va

June 1865. June 1865.
In Monroe. Discharged

* Name dropped as Peter Wilson

Book mark:

[Signature]

M | **1 Cav. | U.S.C.T.**

Palen Wilson

Priv, Co. *B*, 1 Reg't U. S. Col'd Cavalry.

Appears on **Co. Muster-out Roll**, dated

Brazos Santiago, Texas, Feb 7, 1866 .

Muster-out to date _____, 186 .

Last paid to _____, 186 .

Clothing account:

Last settled _____, 186 ; drawn since \$ _____ 100

Due soldier \$ _____ 100; due U. S. \$ _____ 100

Am't for cloth'g in kind or money adv'd \$ _____ 100

Due U. S. for arms, equipments, &c., \$ *32* ^{*46*} 100

Bounty paid \$ _____ 100; due \$ _____ 100

Remarks: *Joined as Recruit. Deserted*

Jan 12, 65 - Fort Monroe Va. For

1 Sabre belt & Plate, 1 Car Couch

& Pick, 1000 Cartridge Box,

1 Turbine sling and swivel, 1 Brush

Thong, Rod Turbine screw driver

Book mark: _____

Fullmer

(361)

Copyist.

ARRA 150

JAN. - 6

5303800

1891 *

and cone wrench, Pistol,
Screw driver and cone wrench,
Colts Revolver 1/2 Shelter tent,
1 Haversack, 1 canteen
Descriptive list sent to A.G.O.
July 14, 65.

¹⁴⁷⁰
Wilson, Reuben

Co C, 1 U. S. Col'd Cav.

Private

Corporal

CARD NUMBERS.

1	53 03 859	26
2	53 03 931	27
8	53 03 957	28
4	53 04 038	29
5	53 04 125	30
6	53 04 211	31
7	53 04 297	32
8	53 04 382	33
9	53 04 491	34
10	53 04 598	35
11	53 04 704	36
12	53 04 809	37
13	53 04 906	38
14	53 04 998	39
15	53 05 087	40
16	9080004	41
17		42
18		43
19		44
20		45
21		46
22		47
23		48
24		49
25		50

Book Mark :

See also

M | 1 Cav. | U.S.C.T.

Ruben Wilson
Co. *C*, 1 Reg't U.S. Col'd Cav.

Appears on
Company Descriptive Book
of the organization named above.

DESCRIPTION.

Age *18* years; height *5* feet *7* inches.

Complexion *Black*

Eyes; *Black* hair *Black*

Where born *Norfolk Va*

Occupation *Waiter*

ENLISTMENT.

When *Dec 4 1863*

Where *Norfolk Va*

By whom *Capt. Brown*; term *3* y'rs.

Remarks: *Promoted to Corp*
Dec 1-1863

Ruben Wilson

W. | 1 Cav. | U.S.C.T.

Reuben Wilson

P. Co. C, 1 Reg't U. S. Col'd Cav.

Age *20* years.

Appears on

Company Muster-in Roll

of the organization named above. Roll dated

Ch. Hamilton, Va., Dec. 22, 1863.

Muster-in to date *Dec. 22, 1863.*

Joined for duty and enrolled:

When *Dec. 4*, 1863 .

Where *Manassas, Va.*

Period *3* years.

Valuation of horse, \$ *100*

Valuation of horse equipments, \$ *100*

Remarks :

Book mark :

Steele

W | 1 Cav. | U.S.C.T.

Reuben Wilson

Plt, Co. C, 1 Reg't U. S. Col'd Cavalry.

Appears on

Company Muster Roll

for *Dec 22 to 31*, 1863.

Present or absent *Present*

Stoppage, \$ *100* for

Due Gov't, \$ *100* for

Valuation of horse, \$ *100*

Valuation of horse equipments, \$ *100*

Remarks:

Book mark:

A. Herman

(358)

Copyist.

H | 1 Cav. | U.S.C.T.

Reuben Wilson

Corp, Co. C, 1 Reg't U. S. Col'd Cavalry.

Appears on

Company Muster Roll

for: *Jan'y + Feb*, 1864.

Present or absent *Present*

Stoppage, \$ 100 for

Due Gov't, \$ 100 for

Valuation of horse, \$ 100

Valuation of horse equipments, \$ 100

Remarks:

Book mark:

A. Kernan

(358)

Copyist.

R | 1 Cav. | U.S.C.T.

Reuben Wilson

Bugler, Co. C, 1 Reg't U. S. Col'd Cavalry.

Appears on

Company Muster Roll

for *Mar + Apr*, 1864.

Present or absent *Present*

Stoppage, \$ *100* for

Due Gov't, \$ *100* for

Valuation of horse, \$ *100*

Valuation of horse equipments, \$ *100*

Remarks:

Book mark:

A. Kerman

(358)

Copyist.

W | 1 Cav. | U.S.C.T.

Ruben Wilson

Bugler, Co. C, 1 Reg't U. S. Col'd Cavalry.

Appears on

Company Muster Roll

for *May + June*, 1864.

Present or absent *Present*

Stoppage, \$ 100 for

Due Gov't, \$ 100 for

Valuation of horse, \$ 100

Valuation of horse equipments, \$ 100

Remarks:

Book mark:

A. Kerman

(358)

Copyist.

W | 1 Cav. | U.S.C.T.

Ruben Wilson

Bugler, Co. C, 1 Reg't U. S. Col'd Cavalry.

Appears on

Company Muster Roll

for *July + Aug*, 1864.

Present or absent *Present*

Stoppage, \$ 100 for

Due Gov't, \$ 100 for

Valuation of horse, \$ 100

Valuation of horse equipments, \$ 100

Remarks:
.....
.....
.....
.....
.....
.....
.....
.....
.....
.....

Book mark:

Adlerman

(358)

Copyist.

W.

1 Cav.

U.S.C.T.

Reuben Wilson

Butler, Co. C, 1 Reg't U. S. Col'd Cavalry.

Appears on

Company Muster Roll

for *Sept and Oct*, 186*1*.

Present or absent *Present*

Stoppage, \$ 100 for

Due Gov't, \$ 78 for *Ordinance*

Lost

Valuation of horse, \$ 100

Valuation of horse equipments, \$ 100

Remarks:

.....
.....
.....
.....
.....
.....
.....
.....
.....

Book mark: *5*

(358) *J. M. Hance* Copyist.

Dr | 1 Cav. | U.S.C.T.

Newman Wilson
Bugler, Co. C, 1 Reg't U. S. Col'd Cavalry.

Appears on

Company Muster Roll

for *Nov. 4th Dec*, 186*4*.

Present or absent *Present*

Stoppage, \$ *100* for

Due Gov't, \$ *1* ^{*23*}/_{*100*} for *Ordman's*
lost

Valuation of horse, \$ *100*

Valuation of horse equipments, \$ *100*

Remarks:

Book mark: -----

(358) *J. M. Hancock* Copyist.

W | 1 Cav. | U.S.C.T.

Reuben Wilson

Byler, Co. C, 1 Reg't U. S. Col'd Cavalry.

Appears on

Company Muster Roll

for *Jan & Feb*, 1865.

Present or absent *Present*

Stoppage, \$ 100 for

Due Gov't, \$ *1* ^{*23*}/_{*100*} for *Ordinance*
lost

Valuation of horse, \$ 100

Valuation of horse equipments, \$ 100

Remarks:

Book mark:

J. M. Hance

(358)

Copyist.

N

1 Cav. | U.S.C.T.

Reuben Wilson

Dugles, Co. C, 1 Reg't U. S. Col'd Cavalry.

Appears on

Company Muster Roll

for *May & Apr*, 186*1*.

Present or absent *Present*

Stoppage, \$ 100 for

Due Gov't, \$ 100 for

Valuation of horse, \$ 100

Valuation of horse equipments, \$ 100

Remarks:

Book mark:

(358)

J. McHarris

Copyist.

W | 1 Cav. | U.S.C.T.

Reuben Wilson

Bugles, Co. C, 1 Reg't U. S. Col'd Cavalry.

Appears on

Company Muster Roll

for *May & June*, 1865.

Present or absent *Present*

Stoppage, \$ *100* for

Due Gov't, \$ *100* for

Valuation of horse, \$ *100*

Valuation of horse equipments, \$ *100*

Remarks:

Book mark :

(358) *J. M. Hance* Copyist.

N. | **1 Cav.** | **U.S.C.T.**

Ruben Wilson

Bugler, Co. C, 1 Reg't U. S. Col'd Cavalry.

Appears on

Company Muster Roll

for *July & Aug.*, 1865.

Present or absent *Present*

Stoppage, \$ *100* for

Due Gov't, \$ *100* for

Valuation of horse, \$ *100*

Valuation of horse equipments, \$ *100*

Remarks: *Due U.S. Camp & Garrison Equipage, one Haversack \$ 0.95*

Book mark:

J. M. Hance

(358)

Copyist.

W

1 Cav. U.S.C.T.

Reuben Wilson

Bugler, Co. C, 1 Reg't U. S. Col'd Cavalry.

Appears on

Company Muster Roll

for *Sept & Oct*, 1865.

Present or absent: *Present*

Stoppage, \$ 100 for

Due Gov't, \$ 100 for

Valuation of horse, \$ 100

Valuation of horse equipments, \$ 100

Remarks:

Book mark:

Carver

(358)

Copyist.

W

1 Cav. | U.S.C.T.

Reuben Wilson

Corpl, Co. C, 1 Reg't U. S. Col'd Cavalry.

Appears on

Company Muster Roll

for *Nov & Dec*, 186 *5*.

Present or absent *Present*

Stoppage, \$ *100* for

Due Gov't, \$ *1* ^{*40*}/_{*100*} for *Ordnance*
lost or destroyed

Valuation of horse, \$ *100*

Valuation of horse equipments, \$ *100*

Remarks: *Promoted to Corpl Dec 1/65*

Book mark:

Sumner

(358)

Copyist.

W | 1 Cav. | U.S.C.T.

Reuben Wilson
 Copt, Co. *C.*, 1 Reg't U. S. Col'd Cavalry.

Appears on **Co. Muster-out Roll**, dated
Brazos Santiago's Tex, Feb 4, 186 *6*.
 Muster-out to date *Feb 11*, 186 *6*.
 Last paid to *Aug 31*, 186 *5*.

Clothing account:

Last settled _____, 186 ; drawn since \$ 100
 Due soldier \$ *3* ^{*73*} 100; due U. S. \$ 100
 Am't for cloth'g in kind or money adv'd \$ 100

Due U. S. for arms, equipments, &c., \$ ^{*40*} 100

Bounty paid \$ *None* 100; due \$ *100* 100

Remarks: *Joined at Original Org.*
Was private until Dec 1/65
Stopped for Pistol screw driver,
Pistol Cartridge, ^{Cap} pouch, lost.
Free before Apr 11/61

Book mark:

Leuner

Wilson, Richard

Co B. L, 1 U. S. Col'd Cav.

Personal papers herein.

Private

Sergeant

CARD NUMBERS.

1	5299362	26
2	5302628	27
3	5302714	28
4	5302801	29
5	5302886	30
6	5302972	31
7	5303069	32
8	5303184	33
9	5303287	34
10	5303403	35
11	5303772	36
12	5314837	37
13	5314908	38
14	5314969	39
15	5315032	40
16	5315089	41
17	9086956	42
18	9085934	43
19	40725506	44
20		45
21		46
22		47
23		48
24		49
25		50

Book Mark:

See also

M | **1 Cav. | U.S.C.T.**

Richard Wilson

Co. *B*, 1 Reg't U.S. Col'd Cav.

Appears on

Company Descriptive Book

of the organization named above.

DESCRIPTION.

Age *19* years; height *5* feet *6* inches.

Complexion *Dark*

Eyes; *Black* hair *Black*

Where born *Allanright Co. Va*

Occupation *Labourer*

ENLISTMENT.

When *Jan 11 - 1864*

Where *Carrif Miss Ga*

By whom *Sp. McHenry*; term *3* y'rs.

Remarks: *Transferred*
in Co "L" 13th Spec. order
No 223, Fed G.O. 1st
U.S.C. May 1st 1865

H. ...

N. | 1 Cav. | U.S.C.T.

Richard Wilson
capt, Co. *L.*, 1 Reg't U.S. Col'd Cav.

Appears on

Company Descriptive Book

of the organization named above.

DESCRIPTION.

Age *20* years; height *5* feet *6* inches.

Complexion *Blk*

Eyes; *Blk* hair *Blk*.

Where born *Allawright Va.*

Occupation *Laborer*

ENLISTMENT.

When *Jan. 18/64*

Where *Camp Mox Va.*

By whom *Capt W Intyre*; term *13* y'rs.

Remarks:

Daggett

W | **1 Cav. | U.S.C.T.**

Richard Wilson

Appears with rank of *Priv* on

Muster and Descriptive Roll of a Detachment of U. S. Vols. forwarded

for the 1 Reg't U. S. Col'd Cavalry. Roll dated

Camp Hamilton Va. Feby 22, 1864.

Where born *Allawright Co. Va.*

Age *19* y'rs; occupation *Laborer*

When enlisted *Jan 11*, 186*4*.

Where enlisted *Camp Mix Va.*

For what period enlisted *3* years.

Eyes *Blk*; hair *Blk*

Complexion *Blk*; height *5 ft. 6 in.*

When mustered in *Feby 22*, 186*4*.

Where mustered in *F. A. Monroe*

Bounty paid \$ *100*; due \$ *100*

Where credited

Company to which assigned

Remarks:

Book mark:

J. A. Harris

(339) Copyist.

11

1 Cav. U.S.C.T.

Richard Wilson
Pvt., Co. B, 1 Reg't U.S. Col'd Cavalry.

Appears on

Company Muster Roll

for Jan. & Feb., 1864.

Present or absent Present

Stoppage, \$ 100 for

Due Gov't, \$ 100 for

Valuation of horse, \$ 100

Valuation of horse equipments, \$ 100

Remarks: Paid due money
Jan 17th 1864

Book mark:

Antawan

11 | **1 Cav.** | **U.S.C.T.**

Richard M. Wilson

Capt., Co. B, 1 Reg't U. S. Col'd Cavalry.

Appears on

Company Muster Roll

for *Wm. H. Felt*, 186*7*.

Present or absent *Present*

Stoppage, \$ *100* for

Due Gov't, \$ *100* for

Valuation of horse, \$ *100*

Valuation of horse equipments, \$ *100*

Remarks:
.....
.....
.....
.....
.....
.....
.....
.....
.....
.....

Book mark:

J. H. Wilson
Copyist.

(358)

W | 1 Cav. | U.S.C.T.

Richard Wilson
Plt, Co. B, 1 Reg't U. S. Col'd Cavalry.

Appears on

Company Muster Roll

for *May Term*, 186*4*.

Present or absent *Present*

Stoppage, \$ 100 for

Due Gov't, \$ 100 for

Valuation of horse, \$ 100

Valuation of horse equipments, \$ 100

Remarks:

Book mark: -----

H. H. H. H. H.
(358) *H. H. H. H. H.* Copyist.

26 | 1 Cav. | U.S.C.T.

Richard Wilson
Pvt., Co. B, 1 Reg't U. S. Col'd Cavalry.

Appears on

Company Muster Roll
for *Jul. Aug.*, 186*x*.

Present or absent *Present*

Stoppage, \$ *100* for

Due Gov't, \$ *100* for

Valuation of horse, \$ *100*

Valuation of horse equipments, \$ *100*

Remarks:

Book mark: -----

Wilson
(358) *Wilson* Copyist.

W. | **1 Cav.** | **U.S.C.T.**

Richard Wilson

P, Co. B, 1 Reg't U. S. Col'd Cavalry.

Appears on

Company Muster Roll

for *Sept. & Oct.*, 1864.

Present or absent *Present*

Stoppage, \$ 100 for

Due Gov't, \$ 100 for

Valuation of horse, \$ 100

Valuation of horse equipments, \$ 100

Remarks:

Book mark:

(358)

Shadbolt

Copyist.

N | **1 Cav.** | **U.S.C.T.**

Richard Wilson

P, Co. B, 1 Reg't U. S. Col'd Cavalry.

Appears on

Company Muster Roll

for *Nov. & Dec.*, 1864.

Present or absent *Absent*

Stoppage, \$ *100* for

Due Gov't, \$ *100* for

Valuation of horse, \$ *100*

Valuation of horse equipments, \$ *100*

Remarks: *On duty a Reg't
H. 2.*

Book mark:

(358)

Shadwell

Copyist.

W. | **1 Cav.** | **U.S.C.T.**

Richard Wilson

P, Co. B, 1 Reg't U. S. Col'd Cavalry.

Appears on

Company Muster Roll

for *Jan & Feb.*, 1865.

Present or absent *Absent*

Stoppage, \$ *100* for

Due Gov't, \$ *100* for

Valuation of horse, \$ *100*

Valuation of horse equipments, \$ *100*

Remarks: *On duty Rgt Hd
2rs.*

Book mark:

(358)

Stadboet

Copyist.

N | 1 Cav. | U.S.C.T.

Richard Nelson

P, Co. B, 1 Reg't U. S. Col'd Cavalry.

Appears on

Company Muster Roll

for *Mar. & Apr.*, 186*1*.

Present or absent *absent*

Stoppage, \$ *100* for

Due Gov't, \$ *100* for

Valuation of horse, \$ *100*

Valuation of horse equipments, \$ *100*

Remarks: *On duty at Regiment
Hd Qrs*

Book mark:

Shadbolt

(358)

Copyist.

W | 1 Cav. | U.S.C.T.

Richard Wilson

P, Co. B, 1 Reg't U. S. Col'd Cavalry.

Appears on

Company Muster Roll

for *May & June*, 1865.

Present or absent

Stoppage, \$ *100* for

Due Gov't, \$ *100* for

Valuation of horse, \$ *100*

Valuation of horse equipments, \$ *100*

Remarks *Transferred for promotion to Co. L. 1st U.S.C. Cav. May 1/65 Spec. order 223 Hd Qrs 1st U.S.C. Due U.S. Ordnance 1⁸⁴*

Book mark:

(358)

Shadbolt

Copyist.

W | 1 Cav. | U.S.C.T.

Richard Wilson

lpl, Co. L, 1 Reg't U. S. Col'd Cavalry.

Appears on

Company Muster Roll

for May & June, 1865

Present or absent Present

Stoppage, \$ 100 for

Due Gov't, \$ 100 for

Valuation of horse, \$ 100

Valuation of horse equipments, \$ 100

Remarks Promoted to lpl. June 10 1865. Transfd. from Co. B. 1st U.S. Col'd Cavalry on account of Co. being full. By order of Maj. Brown Cavalry Regt.

Book mark:

(358)

Copyist.

W | 1 Cav. | U.S.C.T.

Richard Wilson

Sgt, Co. L, 1 Reg't U.S. Col'd Cavalry.

Appears on

Company Muster Roll

for July & Aug., 1865

Present or absent Present

Stoppage, \$ 100 for

Due Gov't, \$ 100 for

Valuation of horse, \$ 100

Valuation of horse equipments, \$ 100

Remarks Promoted to Corporal June 10 1865. Promoted to Sergeant July 29 1865.

Book mark:

(358)

Reif Copyist.

W | 1 Cav. | U.S.C.T.

Richard Wilson

Pvt, Co. L, 1 Reg't U. S. Col'd Cavalry.

Appears on

Company Muster Roll

for Sept, & Oct., 1865.

Present or absent Present

Stoppage, \$ 100 for

Due Gov't, \$ 100 for

Valuation of horse, \$ 100

Valuation of horse equipments, \$ 100

Remarks: Due W.P. for ord. 35 cts.

Book mark:

(358)

Reif

Copyist.

W | 1 Cav. | U.S.C.T.

Richard Wilson

Pvt, Co. L, 1 Reg't U. S. Col'd Cavalry.

Appears on

Company Muster Roll

for Nov. & Dec., 1865.

Present or absent Present

Stoppage, \$ 100 for

Due Gov't, \$ 100 for

Valuation of horse, \$ 100

Valuation of horse equipments, \$ 100

Remarks:

Book mark:

(358)

Ref

Copyist.

No. | 1 Cav. | U.S.C.T.

Richard Wilson

Private, Co. D, 1 Reg't U. S. Colored Cav.
" " Co. L

Appears on Returns as follows:

Joined by Enlisted in
Regt

July 1864 to Jan 1865, on duty
orders for Col. Yarrard
1 US C.C.

From to April 1865. on duty
at Regt Hdqrs

May 18 65. May 1/65.
Gen's Station Transf'd
for promotion to Co. L
Spec 223 Hdqrs. 1 US CC

May 18 65 (Co L) May 5/65.
Gen's Station 7a transf'd
from Co B to Co L

Book mark:

[Signature]

(546)

Copyist.

2

W | **1 Cav.** | **U.S.C.T.**

Richard Wilson

Priv, Co. *B*, 1 Reg't U. S. Col'd Cavalry.

Appears on **Co. Muster-out Roll**, dated
Brazos Santiago Texas, Feby 4, 1866.

Muster-out to date -----, 186 .

Last paid to -----, 186 .

Clothing account:

Last settled -----, 186 ; drawn since \$ ----- 100

Due soldier \$ ----- 100; due U. S. \$ ----- 100

Am't for cloth'g in kind or money adv'd \$ ----- 100

Due U. S. for arms, equipments, &c., \$ ----- 100

Bounty paid \$ ----- 100; due \$ ----- 100

Remarks: *joined as recruit*

transferred to Co. G. U. S. C. C.

S. O. 223 74d. 2ro. U. S. C. C. May 1, 65

Descriptive list furnished

May 1, 1865

Book mark : -----

J. Faulkner

(361)

Copyist.

W | | bar | U.S.C.T.

Richard Wilson

Sgt, Co. D, 1 Reg't U. S. Col'd

Appears on Co. Muster-out Roll, dated
Brazos Santiago Tex Feb. 4, 1866.

Muster-out to date Feb. 4, 1866.

Last paid to Aug. 31, 1865.

Clothing account:

Last settled _____, 186 ; drawn since \$ _____ 100

Due soldier \$ $52 \frac{18}{100}$; due U. S. \$ _____ 100

Am't for cloth'g in kind or money adv'd \$ _____ 100

Due U. S. for arms, equipments, &c., \$ _____ $\frac{35}{100}$

Bounty paid \$ ~~None~~ $\frac{100}{100}$; due \$ $300 \frac{100}{100}$

Remarks: joined as Ret. was free
Apr 19 1861 Transfd from
Co B to D By order of Maj.
H. Brown S.O. No 223 dated
Kelly Station May 18 1865
Was Pat to June 16 1865 lpt
over

Book mark: _____

(361)

Ref

Copyist.

MARR 1965

JAN. - 7

5315039

★ 1891 ★

to July 29 /65.

due A.P. for one barline
screw driver and one
home wrench

Wilson, Richard

P, Co. B^{and} 2

1 Regt U.S.C. Cav.

Enclosures.

Bed Cards	Descriptive Lists
Burial Records	Final Statements
Certs. of Dis. for Discharge	Furloughs
C. M. Charges	Med. Des. Lists
Med. Certificates	Orders

Other papers relating to—

Admission to Hosp'l	Furlough
Casualty Sheet (Officer's)	Med. Examination
Confinement	Misc. Information
Contracts	Pay or Clothing
Death or Effects	Personal Reports
Desertions	Rank
Discharge from Hosp'l	Transfer to Hosp'l
Discharge from Service	Transfer to V. R. C.
Duty	Transportation

May 1/65

Wilson, Richard.

P.O. Box 2, 1st. Fl. C. Ave.

Head Quarters 1st US CG
Fetty Station Va May 1st 1863

Special Order
No 223

Private Richard
Wilson Squadron "B" is hereby transferred
to Squadron "F"

By Order of
Maj G. H. Brown

George
P. Mantz
1st Lt Adjutant

1497

Wilson, Richard
 Co F, 1 U. S. Col'd Cav.

Private

Private

CARD NUMBERS.

1	5307951	26
2	5308020	27
3	5308102	28
4	5308186	29
5	5308276	30
6	5300360	31
7	5308362	32
8	5308449	33
9	5308546	34
10	5308655	35
11	5308763	36
12	5308869	37
13	5308972	38
14	5309078	39
15	5309171	40
16	5309267	41
17	9086357	42
18	34354857	43
19	40725548	44
20		45
21		46
22		47
23		48
24		49
25		50

Book Mark: *284.563*

See also

W. | **1 Cav. | U.S.C.T.**

Richard Wilson,

....., Co. *F*....., 1 Reg't U.S. Col'd Cav.

Appears on

Company Descriptive Book

of the organization named above.

DESCRIPTION.

Age *45* years; height *5* feet *9* inches.

Complexion *Black.*

Eyes; *Black* hair *Wooly.*

Where born *Norfolk Va.*

Occupation *Servt.*

ENLISTMENT.

When *Dec 7-63.*

Where *Norfolk*

By whom *Capt Brown*; term *3* y'rs.

Remarks:

.....

.....

.....

.....

.....

.....

.....

.....

.....

.....

.....

.....

.....

.....

.....

.....

.....

.....

.....

.....

.....

.....

.....

.....

.....

.....

Dickerson.

N | 1 Cav. | U.S.C.T.

Richard Wilson

Pri, Co. *F*, 1 Reg't U. S. Col'd Cavalry.

Age *45* years.

Appears on

Company Muster-in Roll

of the organization named above. Roll dated

Camp Hamilton Va, *Dec. 22*, 1863.

Muster-in to date *Dec. 22*, 1863.

Joined for duty and enrolled:

When *Dec. 7*, 1863.

Where *Norfolk Va*

Period *3* years.

Valuation of horse, \$ 100

Valuation of horse equipments, \$ 100

Remarks:

Book mark:-----

(356)

Perry

Copyist.

A | 1 Cav. | U.S.C.T.

Richard Wilson

Priv, Co. F, 1 Reg't U. S. Col'd Cavalry.

Appears on

Company Muster Roll

for *22 Dec to 31 Dec*, 1863.

Present or absent *Present*

Stoppage, \$ *100* for

Due Gov't, \$ *100* for

Valuation of horse, \$ *100*

Valuation of horse equipments, \$ *100*

Remarks:

Book mark:

Perry

(358)

Copyist.

A | 1 Cav. | U.S.C.T.

Richard Wilson

Priv, Co. F, 1 Reg't U. S. Col'd Cavalry.

Appears on

Company Muster Roll

for *Jan - Feb*, 1864.

Present or absent *Present*

Stoppage, \$ *100* for

Due Gov't, \$ *100* for

Valuation of horse, \$ *100*

Valuation of horse equipments, \$ *100*

Remarks:

Book mark:

Perry

(358)

Copyist.

A | **1 Cav.** | **U.S.C.T.**

Richard Wilson

Cmn, Co. F, 1 Reg't U. S. Col'd Cavalry.

Appears on

Company Muster Roll

for *Mch 1st*, 1864.

Present or absent *Present*

Stoppage, \$ *100* for

Due Gov't, \$ *100* for

Valuation of horse, \$ *100*

Valuation of horse equipments, \$ *100*

Remarks:

Book mark:

(358)

Cerry

Copyist.

A

1 Cav. | U.S.C.T.

Richard Wilson

Private, Co. F, 1 Reg't U. S. Col'd Cavalry.

Appears on

Company Muster Roll

for *May & June*, 1864.

Present or absent *Absent*

Stoppage, \$ 100 for

Due Gov't, \$ 100 for

Valuation of horse, \$ 100

Valuation of horse equipments, \$ 100

Remarks: *On D-S per S.O.
Hd. Qrs. 1st U.S.C.C.
June 29, 1864*

Book mark:

Cerry Copyist.

(358)

W 1 | Cav | U.S.C.T.

Richard Wilson

Pvt, Co., 1 Reg't U. S. Col'd Cavalry

Appears on a

Detachment Muster Roll

of the organization named above

for: May & June, 1864

Station: Battlefield near Petersburg Va

Present or absent Present

Stoppage, \$ 100 for

Due Gov't, \$ 100 for

Valuation of horse, \$ 100

Valuation of horse equipments, \$ 100

Remarks:

Book mark:

(341)

W. Hammer

Copyist.

W. V. Cav. W.S.C.T

Rimus Wilson
1st Regt U.S. Cold Cav.

Appears on

Muster Roll

of Enlisted Men, Ambulance Corps, 1 Division,
18 Army Corps,

for *May + June*, 186*4*.

Station *In the Field*

Clothing account:

Last settled....., 186 ; drawn since \$.....¹⁰⁰

Present or absent *Present*

Remarks: *Detailed to*
Amb. Corps,

+ Col. Fred de Rimus

Book mark:

Ragan

W. | **1 Cav.** | **U.S.C.T.**

Richard Wilson

Priv, Co. F, 1 Reg't U.S. Col'd Cavalry.

Appears on

Company Muster Roll

for *July Aug*, 186*4*.

Present or absent *Present*

Stoppage, \$ *100* for

Due Gov't, \$ *100* for

Valuation of horse, \$ *100*

Valuation of horse equipments, \$ *100*

Remarks:

Book mark:

Perry

(358)

Copyist.

W | 1 Cav. | U.S.C.T.

Richard Wilson

Pr, Co. F, 1 Reg't U. S. Col'd Cavalry.

Appears on

Company Muster Roll

for *Sept 1864*, 1864.

Present or absent *Present*

Stoppage, \$ *100* for

Due Gov't, \$ *100* for

Valuation of horse, \$ *100*

Valuation of horse equipments, \$ *100*

Remarks:

Book mark:

J. Wilson

(358)

Copyist.

W | **1 Cav.** | **U.S.C.T.**

Richard Wilson

Priv, Co. F, 1 Reg't U. S. Col'd Cavalry.

Appears on

Company Muster Roll

for *Nov. 1864*, 186 *4*

Present or absent *Present*

Stoppage, \$ *100* for

Due Gov't, \$ *100* for

Valuation of horse, \$ *100*

Valuation of horse equipments, \$ *100*

Remarks: *Due U.S. for one
Pr Spurs & Straps. 60*

Book mark:

J. L. Lewis

(358)

Copyist.

N | 1 Cav. | U.S.C.T.

Richard Wilson

Priv, Co. F, 1 Reg't U. S. Col'd Cavalry.

Appears on

Company Muster Roll

for *Jan & Feb*, 1865.

Present or absent *Present*

Stoppage, \$ *100* for

Due Gov't, \$ *100* for

Valuation of horse, \$ *100*

Valuation of horse equipments, \$ *100*

Remarks: *due US for
one Pr Spurs &
straps .60*

Book mark:

(358)

J. M. Leonard

Copyist.

H | **1 Cav. | U.S.C.T.**

Richard Wilson

Priv., Co. F, 1 Reg't U. S. Col'd Cavalry.

Appears on

Company Muster Roll

for *Mar. & Apr.*, 1865.

Present or absent *Present*

Stoppage, \$ *100* for

Due Gov't, \$ *100* for

Valuation of horse, \$ *100*

Valuation of horse equipments, \$ *100*

Remarks:

Book mark:

(358)

J. W. Leonard

Copyist.

W | 1 Cav. | U.S.C.T.

Richard Wilson

Priv., Co. F, 1 Reg't U. S. Col'd Cavalry.

Appears on

Company Muster Roll

for *May & June*, 1865.

Present or absent *Present*

Stoppage, \$ *100* for

Due Gov't, \$ *100* for *1*

Valuation of horse, \$ *100*

Valuation of horse equipments, \$ *100*

Remarks: *Due U.S. One
Colts Army Pistol
\$20.00*

Book mark:

A. J. [Signature]

(358)

Copyist.

W

1 Cav.

U.S.C.T.

Richard Wilson

Priv

, Co. F, 1 Reg't U. S. Col'd Cavalry.

Appears on

Company Muster Roll

for July & Aug, 1865.

Present or absent Present

Stoppage, \$ 100 for

Due Gov't, \$ 100 for

Valuation of horse, \$ 100

Valuation of horse equipments, \$ 100

Remarks: Due U.S. for
Colt's Army Pistol
\$20.00

Book mark:

J. U. Leonard

(358)

Copyist.

W. | 1 Cav. | U.S.C.T.

Richard Wilson

Priv, Co. F, 1 Reg't U.S. Col'd Cavalry.

Appears on

Company Muster Roll

for *Sept & Oct.*, 1865.

Present or absent *Priv.*

Stoppage, \$ 100 for

Due Gov't, \$ 100 for

Valuation of horse, \$ 100

Valuation of horse equipments, \$ 100

Remarks:

Book mark:

(358)

R J Coyle

Copyist.

W. | 1 Cav. | U.S.C.T.

Richard Wilson
Priv, Co. F, 1 Reg't U. S. Col'd Cavalry.

Appears on

Company Muster Roll

for *Nov and Dec*, 186*0*.

Present or absent *Present*

Stoppage, \$ 100 for

Due Gov't, \$ 100 for

Valuation of horse, \$ 100

Valuation of horse equipments, \$ 100

Remarks:

Book mark:

B J Cook
Copyist.

(358)

M | 1 Cav. | U.S.C.T.

Wilson 4th

Boy, Co. *F*, 1 Reg't U. S. Colored Cav.

Appears on Returns as follows:

*June 1864 absent on
D.S. for S.O. Hager
1 U.S. C. Co. June 26*

Book mark :

at 1/2

W. | 1 Cav. | U.S.C.T.

Richard Wilson

Prvt, Co. *F*, 1 Reg't U. S. Col'd Cavalry.

Appears on Co. Muster-out Roll, dated

Proprs Santiago, Tex, Feb. 4, 1866.

Muster-out to date *Feb. 4, 1866.*

Last paid to *Aug. 31, 1865.*

Clothing account:

Last settled....., 186 ; drawn since \$.....¹⁰⁰

Due soldier \$.....¹⁰⁰; due U. S. \$ *4* ^{*58*}/₁₀₀

Am't for cloth'g in kind or money adv'd \$.....¹⁰⁰

Due U. S. for arms, equipments, &c., \$.....¹⁰⁰

Bounty paid \$ *None* ¹⁰⁰; due \$ *100* ¹⁰⁰

Remarks: *Joined at Augt Ariz.*

Free before April 19th 61.

Book mark: *284.563.*

(361)

R. J. Cooke

Copyist.

Wilson, Samuel

Co H, 1 U. S. Col'd Cav.

Captain

Private

CARD NUMBERS.

1	5310679	26
2	5310748	27
3	5310817	28
4	5310889	29
5	5311016	30
6	5300271	31
7	5311099	32
8	5311189	33
9	5311294	34
10	5311398	35
11	5311504	36
12	5311605	37
13	5311709	38
14	5311809	39
15	5311908	40
16	5312005	41
17	9086571	42
18	9086566	43
19	34355215	44
20	40725537	45
21		46
22		47
23		48
24		49
25		50

Book Mark: V.S.P. 109/61, V40P60.68

See also

W. | Cav. | U.S.C.T.

Samuel Wilson.

Co. H, 1 Reg't U. S. Col'd Cavl.

Appears on

Company Descriptive Book

of the organization named above.

DESCRIPTION.

Age 20 years; height 5 feet 2 inches.

Complexion Black.

Eyes Black; hair Black.

Where born Norfolk Va.

Occupation _____

ENLISTMENT.

When Dec 11, 1863.

Where Norfolk

By whom Capt Brown; term 3 y'rs.

Remarks: _____

Dickerson.

(383g)

Copyist.

W. | *1 Cav.* | **U.S.C.T.**

Samuel Wilson.

, Co. H, 1 Reg't U. S. Col'd *Caval.*

Appears on

Company Descriptive Book

of the organization named above.

DESCRIPTION.

Age *22* years ; height *5* feet inches.

Complexion *Light*

Eyes *Black* ; hair *Black*

Where born *Norfolk, Va.*

Occupation *Butler.*

ENLISTMENT.

When *Dec 12*, 18*63*.

Where *Norfolk Va.*

By whom *Capt Brown*; term *3* y'rs.

Remarks:

Dickerson.

11 | **1 Cav.** | **U.S.C.T.**

Samuel Wilson

Co. 4, 1 Reg't U. S. Col'd Cavalry.

Age 20 years.

Appears on

Company Muster-in Roll

of the organization named above. Roll dated

Sp. Hamilton Va, Dec 22, 1863.

Muster-in to date Dec, 1863.

Joined for duty and enrolled:

When Dec 11, 1863.

Where Sp. Hamilton Va.

Period 3 years.

Valuation of horse, \$ 100

Valuation of horse equipments, \$ 100

Remarks:
.....
.....
.....
.....

Book mark:
.....

(356)

Wm. J. ...

Copyist.

J | 1 Cav. | U.S.C.T.

Samuel Wilson

Co. II, Co. II, 1 Reg't U. S. Col'd Cavalry.

Appears on

Company Muster Roll

for *Dec 1st*, 186*5*.

Present or absent *Present*

Stoppage, \$ *100* for

Due Gov't, \$ *100* for

Valuation of horse, \$ *100*

Valuation of horse equipments, \$ *100*

Remarks:

*Discharged by order
of the commanding officer*

Book mark:

(358)

Samuel Wilson
Copyist.

1 Cav. U.S.C.T.

William S. Wilson
Co. H, 1 Reg't U. S. Col'd Cavalry.

Appears on

Company Muster Roll

for *William S. Wilson*, 186*4*.

Present or absent *Present*

Stoppage, \$ *100* for

Due Gov't, \$ *100* for

Valuation of horse, \$ *100*

Valuation of horse equipments, \$ *100*

Remarks:

Book mark: -----

(358) *William S. Wilson* Copyist.

24 | 1 Cav. | U.S.C.T.

James Wilson

Co. H, Co. H, 1 Reg't U. S. Col'd Cavalry.

Appears on

Company Muster Roll

for *Feb 24*, 186*7*.

Present or absent *Present*

Stoppage, \$ *100* for

Due Gov't, \$ *100* for

Valuation of horse, \$ *100*

Valuation of horse equipments, \$ *100*

Remarks:

Book mark:

(358)

W. L. ...

Copyist.

67 | U.S.C.T.

Wm. H. ...
... Co. ... / Reg't U. S. Col'd ...

Appears on

Company Muster Roll

for *Sept 1861*, 1861.

Present or absent *Present*

Stoppage, \$ 100 for

Due Gov't, \$ 100 for

Valuation of horse, \$ 100

Valuation of horse equipments, \$ 100

Remarks:
Admitted to service in ...
... 1st ...

Book mark:

(358)

W. H. ...
Copyist.

W *V Cav.* *W807*

Samuel Wilson
Priv 1 Regt W.S. Cav. Co.

Appears on

Muster Roll

of Enlisted Men, Ambulance Corps, 2 Division,
18 Army Corps,

for *May June*, 1864.

Station *In the Field, Va*

Clothing account:

Last settled _____, 186; drawn since \$ 100

Present or absent *Present*

Remarks: _____

Book mark: _____

Ryan

(520)

Copyist.

Or | 1 Cav. | **U.S.C.T.**

Samuel Wilson

....., Co....., | 1 Reg't U. S. Col'd Cavly

Appears on a

Detachment Muster Roll

of the organization named above

for May & June, 1864

Station In the field Va. near Petersburg

Present or absent Present

Stoppage, \$ 100 for

Due Gov't, \$ 100 for

Valuation of horse, \$ 100

Valuation of horse equipments, \$ 100

Remarks :

Book mark :

(344)

Hammer

Copyist.

1 Cav. U.S.C.T.

....., Co. H, 1 Reg't U. S. Col'd Cavalry.

Appears on

Company Muster Roll

for, 186.....

Present or absent

Stoppage, \$.....¹⁰⁰ for

Due Gov't, \$.....¹⁰⁰ for

Valuation of horse, \$.....¹⁰⁰

Valuation of horse equipments, \$.....¹⁰⁰

Remarks:

.....
.....
.....
.....
.....
.....
.....
.....

Book mark:

.....

(358)

[Signature]
Copyist.

H | 1 Cav. | U.S.C.T.

Samuel Wilson

Plt, Co. H, 1 Reg't U. S. Col'd Cavalry.

Appears on

Company Muster Roll

for *Sept - Oct*, 186*4*.

Present or absent *Present*

Stoppage, \$ *100* for

Due Gov't, \$ *100* for

Valuation of horse, \$ *100*

Valuation of horse equipments, \$ *100*

Remarks:

.....
.....
.....
.....
.....
.....
.....
.....

Book mark:

W. Jackson
Copyist.

(358)

A | 1 Cav. | U.S.C.T.

Samuel Gibson

Priv, Co. H, 1 Reg't U. S. Col'd Cavalry.

Appears on

Company Muster Roll

for *Nov - Dec*, 1864

Present or absent *Present*

Stoppage, \$ *100* for

Due Gov't, \$ *100* for

Valuation of horse, \$ *100*

Valuation of horse equipments, \$ *100*

Remarks:

Book mark:

(358)

A Jackson
Copyist.

24 | **1 Cav. | U.S.C.T.**

Samuel Wilson

Priv, Co. H, 1 Reg't U. S. Col'd Cavalry.

Appears on

Company Muster Roll

for *Jan & Feb*, 1865.

Present or absent *Present*

Stoppage, \$ *100* for

Due Gov't, \$ *100* for

Valuation of horse, \$ *100*

Valuation of horse equipments, \$ *100*

Remarks:

Book mark:

(358)

M Jackson

Copyist.

27 | **1 Cav. | U.S.C.T.**

Samuel Wilson

Cpt, Co. H, 1 Reg't U. S. Col'd Cavalry.

Appears on

Company Muster Roll

for *March & April*, 1865.

Present or absent *Present*

Stoppage, \$ *100* for

Due Gov't, \$ *100* for

Valuation of horse, \$ *100*

Valuation of horse equipments, \$ *100*

Remarks:

Book mark:

(358)

M Jackson
Copyist.

24 | 100 | U.S.C.T.

Samuel Wilson
Plt, Co. H, 1st Reg't U. S. Col'd. Cad

Appears on

Company Muster Roll

for May June, 1865.

Present or absent Present

Stoppage, \$ 100 for

Due Gov't, \$ 100 for

Valuation of horse, \$ 100

Valuation of horse equipments, \$ 100

Remarks:

Book mark:

(358)

M Jackson
Copyist.

24 | 1 Cav. | U.S.C.T.

Samuel Wilson

Gov, Co. H, 1 Reg't U. S. Col'd Cavalry.

Appears on

Company Muster Roll

for *July & Aug*, 186 *5*

Present or absent *Present*

Stoppage, \$ *100* for

Due Gov't, \$ *100* for

Valuation of horse, \$ *100*

Valuation of horse equipments, \$ *100*

Remarks:

Book mark:

(358)

M Jackson

Copyist.

W | 1 Cav. | U.S.C.T.

Saul Wilson

Pt, Co. H, 1 Reg't U. S. Col'd Cavalry.

Appears on

Company Muster Roll

for Sept & Oct, 1865

Present or absent Present

Stoppage, \$ 100 for

Due Gov't, \$ 100 for

Valuation of horse, \$ 100

Valuation of horse equipments, \$ 100

Remarks:

Book mark:

Stewart

(358)

Copyist.

W | 1 Cav. | U.S.C.T.

Samuel C Wilson

Pt, Co. H, 1 Reg't U. S. Col'd Cavalry.

Appears on

Company Muster Roll

for Nov & Dec, 1867.

Present or absent Present

Stoppage, \$ 100 for

Due Gov't, \$ 100 for

Valuation of horse, \$ 100

Valuation of horse equipments, \$ 100

Remarks:

Book mark:

J Stewart

(358)

Copyist.

W | 1 Cav. | U. S. C. T.

Samuel Wilson

Pvt., Co. H, 1 Reg't U. S. Col'd Cav.

Appears on Returns as follows:

Apr 1864, Absent at
Camp Mix, Va

Nov & Dec 1863: On duty
orderly for Comdg
Officer Co. H

Book mark:

J. C. [Signature]

(546)

Copyist.

W | **1 Cav.** | **U.S.C.T.**

Samuel Wilson

Pt, Co. *A*, 1 Reg't U. S. Col'd Cavalry.

Appears on **Co. Muster-out Roll**, dated *Brazos Santiago, Tex Feb 4, 1866.*

Muster-out to date *Feb 4, 1866.*

Last paid to *Aug 31, 1865.*

Clothing account:

Last settled _____, 186 ; drawn since \$ _____ 100

Due soldier \$ _____ 100; due U. S. \$ *8* / 100

Am't for cloth'g in kind or money adv'd \$ _____ 100

Due U. S. for arms, equipments, &c., \$ _____ 100

Bounty paid \$ _____ 100; due \$ _____ 100

Remarks: *joined at Orgo. g*
was private until Dec 15/63
Corp until June 1/64

Book mark: *V. S. P. 109/61, V40 P60.68*

J. H. Stewart
(361) Copyist.

1497

Wilson, Thomas

Co *G* **1** U. S. Col'd Cav.

Personal papers herein.

Personal papers herein.

Private

Private

CARD NUMBERS.

1	5299499	26
2	5299514	27
3	5309956	28
4	5310063	29
5	5310170	30
6	5310281	31
7	5300696	32
8	5310655	33
9	9086490	34
10	40725508	35
11		36
12		37
13		38
14		39
15		40
16		41
17		42
18		43
19		44
20		45
21		46
22		47
23		48
24		49
25		50

Book Mark: *E.B.V. 10.P.588.*

See also

W. | **1 Cav. | U.S.C.T.**

Thomas Wilson,

....., Co. G., 1 Reg't U.S. Col'd Cav.

Appears on

Company Descriptive Book

of the organization named above.

DESCRIPTION.

Age 19 years; height 5 feet 6 inches.

Complexion Blk.

Eyes; Blk. hair Blk.

Where born Norfolk Co. Va

Occupation Laborer.

ENLISTMENT.

When Sept- 14/64

Where Poughkeepsie

By whom Capt Johnson; term One y'rs.

Remarks: Bounty Paid \$33 1/3

Dickerson,

W. | **1 Cav.** | **U.S.C.T.**

Thomas Wilson

Appears with rank of Sgt. on

Muster and Descriptive Roll of a Detachment of U. S. Vols. forwarded

for the 1 Reg't U. S. Col'd Cavalry. Roll dated

Cokee, Va., Sept. 26, 1864.

Where born Virginia

Age 27 y'rs; occupation Laborer

When enlisted Sept. 26, 1864.

Where enlisted Cokee, Va.

For what period enlisted 1 years.

Eyes Blue; hair Black

Complexion Black; height 5 ft. 8 in.

When mustered in Sept. 26, 1864.

Where mustered in Cokee, Va.

Bounty paid \$ 33 ³⁷/₁₀₀; due \$ 100 ⁰⁰/₁₀₀

Where credited 12 Comp. Det.
37 Sub. Det.

Company to which assigned _____

Remarks: _____

Book mark: _____

N. | 1 Cav. | U.S.C.T.

Shamus Wilson

Appears with rank of S. N. on

Muster and Descriptive Roll of a Detachment of U. S. Vols. forwarded

for the 1 Reg't U. S. Col'd Cavalry. Roll dated

Mar 21, 1864.

Where born Va.

Age 27 y'rs; occupation Laborer

When enlisted September, 1864.

Where enlisted Co. B. 1st Regt.

For what period enlisted 1 years.

Eyes Blue; hair Blue

Complexion Fair; height 5 ft. 6 in.

When mustered in September, 1864.

Where mustered in Co. B. 1st Regt.

Bounty paid \$33 ³³/₁₀₀; due \$ ¹⁰⁰/₁₀₀

Where credited 12 Com. Dist. 32 1st Dist.

Company to which assigned

Remarks:

Book mark:

(339)

Signature

Copyist.

W | 1 Cav. | U.S.C.T.

Thomas Wilson

Pvt, Co. G, 1 Reg't U. S. Col'd Cavalry.

Appears on

Company Muster Roll

for *Nov. & Dec.*, 186*4*.

Present or absent *Present*

Stoppage, \$ *100* for

Due Gov't, \$ *100* for

Valuation of horse, \$ *100*

Valuation of horse equipments, \$ *100*

Remarks: *Bounty Paid \$33 1/3 -*

Book mark:

W H Thompson

(358)

Copyist.

W | 1 Cav. | U.S.C.T.

Thomas Wilson

Priv, Co. G, 1 Reg't U. S. Col'd Cavalry.

Appears on

Company Muster Roll

for *Jerry & Peby*, 186 *s.*

Present or absent *Present*

Stoppage, \$ *100* for

Due Gov't, \$ *100* for

Valuation of horse, \$ *100*

Valuation of horse equipments, \$ *100*

Remarks:

Book mark:

W. H. Thompson
Copyist.

(358)

W

1 Cav. U.S.C.T.

Thomas Wilson

Priv, Co. G, 1 Reg't U. S. Col'd Cavalry.

Appears on

Company Muster Roll

for *Mich & ap*, 1865.

Present or absent *Present*

Stoppage, \$ 100 for

Due Gov't, \$ 100 for

Valuation of horse, \$ 100

Valuation of horse equipments, \$ 100

Remarks:

Book mark:

W H Thompson
Copyist.

(358)

W | 1 Cav. | U.S.C.T.

Thomas Wilson

Pvt, Co. G, 1 Reg't U. S. Col'd Cavalry.

Appears on

Company Muster Roll

for *May & June*, 1865.

Present or absent

Stoppage, \$ 100 for

Due Gov't, \$ 100 for

Valuation of horse, \$ 100

Valuation of horse equipments, \$ 100

Remarks: *Discharge & final
Statements given May
27/65, as per G.O. No 83.
War Dept. A.G.O.*

Book mark: *Discharged May 26/65,
E.B.V. 10, P. 588.*

(358)

W H Thompson
Copyist.

N 1600 U.S.C.T.

Thomas Wilson
 Pvt, Co. G, 1 Reg't U. S. Col'd *600*

Appears on an

Individual Muster-out Roll

of the organization named above. Roll dated

City Point, Va, May 26, 1865.

Muster-out to date *May 26, 1865.*

Last paid to *Dec, 31, 1864.*

Clothing account:

Last settled _____, 186 ; drawn since \$ _____ 100

Due soldier \$ _____ 100; due U. S. \$ _____ 100

Am't for cloth'g in kind or money adv'd \$ *43 09* / 100
(Since enrollment)

Due U. S. for arms, equipments, &c., \$ _____ 100

Bounty paid \$ *33 33 1/3* / 100 due \$ *33 33* / 100

Remarks: *Disch'gd under*
D.O. 83 War
Sept. A.G.O.
Washington D.C.
May 8, 1865.

Book mark: _____

(348) *Saxton* Copyist.

W | 1 Cav. | U.S.C.T.

Thomas Wilson

Priv, Co. *G*, 1 Reg't U. S. Colored Cav.

Appears on Returns as follows:

May 1865. May 26.

*City Point Va. Discharged
from service per G.O. 83.
admitted Ward Dept. ago.
Washington D.C.*

Book mark:

Chas. Patten

(546)

Copyist.

A | 1 Cav. | U.S.C.T.

Thomas Wilson

Priv, Co. *G*, 1 Reg't U. S. Col'd Cavalry.

Appears on **Co. Muster-out Roll**, dated

Brazos Santiago Tx Feb 4, 1866.

Muster-out to date _____, 186 .

Last paid to _____, 186 .

Clothing account:

Last settled _____, 186 ; drawn since \$ _____ 100

Due soldier \$ _____ 100; due U. S. \$ _____ 100

Am't for cloth'g in kind or money adv'd \$ _____ 100

Due U. S. for arms, equipments, &c., \$ _____ 100

Bounty paid \$ _____ 100; due \$ _____ 100

Remarks: *Joined as Recruit*

*Mustered out May 26/65 at
City Point Va. pr GO 83 dated
War Dept A GO Washington
DC May 3/65*

Book mark : _____

(361)

Moy

Copyist.

Wilson, Thomas.

P, Co. G., 1 Regt U.S.C. Cav.

/ Enclosures.

Bed Cards	Descriptive Lists
Burial Records	Final Statements
Certs. of Dis. for Discharge	Furloughs
C. M. Charges	Med. Des. Lists
Med. Certificates	Orders

Other papers relating to—

Admission to Hosp'l	Furlough
Casualty Sheet (Officer's)	Med. Examination
Confinement	Misc. Information
Contracts	Pay or Clothing
Death or Effects	Personal Reports
Desertions	Rank
Discharge from Hosp'l	Transfer to Hosp'l
Discharge from Service	Transfer to V. R. C.
Duty	Transportation

War Department,

ADJUTANT GENERAL'S OFFICE,

February 4th, 1874

The *Account* of *James M. ...*
..., Co. "G", 1st Reg't U. S.
 Colored *Company*, is reported as follows:—

	On Company Muster Roll.	
For	<i>...</i> , 186 <i>...</i>	<i>...</i> , 186 <i>...</i>
	Company Muster-out Roll.	
	<i>...</i>	<i>...</i> , 186 <i>...</i>
	Company Descriptive Book.	
	<i>...</i>	<i>...</i> , 186
	Company Morning Reports.	
	<i>...</i>	<i>...</i> , 186
	Soldier's Final Statement.	
	<i>...</i>	<i>...</i> , 186
	Soldier's Record of Death and Interment.	
	<i>...</i>	<i>...</i> , 186
	Soldier's Inventory of Effects.	
	<i>...</i>	<i>...</i> , 186
	Soldier's Certificate of Disability for Discharge.	
	<i>...</i>	<i>...</i> , 186
	Soldier's Individual Muster-out Roll.	
	<i>...</i>	<i>...</i> , 186 <i>...</i>
	Regimental Return.	
For	<i>...</i> , 186	<i>...</i> , 186
	Regimental Quarterly Returns.	
	<i>...</i>	<i>...</i> , 186
	Regimental Descriptive Book.	
	<i>...</i>	<i>...</i> , 186
	By Surgeon General.	
(<i>...</i>	<i>...</i> , 186

May 2nd, 186*...*, is held to be the correct date, and the Company Muster Roll will be amended accordingly.

Thomas M. ...
 Asst. Adjt. Gen.

CB. 10 See letter to 2^d Aud.
Vol. 388 Mar 10 1874
36, 11
 J. ... on Register

150
Wilson, Timus

Co F, 1 U. S. Col'd Cav.

Private

Private

CARD NUMBERS.

1	5307950	26
2	5308019	27
3	5308101	28
4	5308184	29
5	5308274	30
6	5300457	31
7	5308360	32
8	5308447	33
9	5308544	34
10	5308653	35
11	5308761	36
12	5308867	37
13	5308970	38
14	5309076	39
15	5309169	40
16	5309265	41
17	9086350	42
18		43
19		44
20		45
21		46
22		47
23		48
24		49
25		50

Book Mark: 2345, 1880

See also

W. | 1 Cav. | U.S.C.T.

Timus Wilson

....., Co. *F*....., 1 Reg't U.S. Col'd Cav.

Appears on

Company Descriptive Book

of the organization named above.

DESCRIPTION.

Age *27* years; height *5* feet *9* inches.

Complexion *Black.*

Eyes; *Black* hair *Wooly.*

Where born *Norfolk Va.*

Occupation *Serv-*

ENLISTMENT.

When *Dec 7-63*

Where *Norfolk*

By whom *Capt Brown*; term *3* y'rs.

Remarks:

.....

Dickerson.

W | **1 Cav.** | **U.S.C.T.**

Timms Wilson

Pri, Co. *7*, 1 Reg't U. S. Col'd Cavalry.

Age *27* years.

Appears on

Company Muster-in Roll

of the organization named above. Roll dated

Camp Hamilton Va, Dec. 22, 1863.

Muster-in to date *Dec. 22, 1863.*

Joined for duty and enrolled:

When *Dec. 7,* 1863.

Where *Norfolk, Va.*

Period *3* years.

Valuation of horse, \$.....100

Valuation of horse equipments, \$.....100

Remarks:

.....

.....

.....

Book mark:

(356)

Cerry

Copyist.

A | 1 Cav. | U.S.C.T.

James Wilson

Qui, Co. F, 1 Reg't U. S. Col'd Cavalry.

Appears on

Company Muster Roll

for *22 Dec to 31 Dec*, 1863.

Present or absent *Present*

Stoppage, \$ *100* for

Due Gov't, \$ *100* for

Valuation of horse, \$ *100*

Valuation of horse equipments, \$ *100*

Remarks:

Book mark:

Cerry

(358)

Copyist.

A | 1 Cav. | U.S.C.T.

Timus Wilson

Pvt, Co. F, 1 Reg't U. S. Col'd Cavalry.

Appears on

Company Muster Roll

for *Jan & Feb*, 1864.

Present or absent *Present*

Stoppage, \$ *100* for

Due Gov't, \$ *100* for

Valuation of horse, \$ *100*

Valuation of horse equipments, \$ *100*

Remarks:

Book mark:

Perry

(358)

Copyist.

11

1 Cav. U.S.C.T.

James Wilson

Pvt, Co. F, 1 Reg't U. S. Col'd Cavalry.

Appears on

Company Muster Roll

for Mch & Apl, 1864.

Present or absent Present

Stoppage, \$ 100 for

Due Gov't, \$ 100 for

Valuation of horse, \$ 100

Valuation of horse equipments, \$ 100

Remarks:

[Empty lines for remarks]

Book mark:

Perry

(358)

Copyist.

A | 1 Cav. | U.S.C.T.

Timms Wilson

Pri, Co. F, 1 Reg't U. S. Col'd Cavalry.

Appears on

Company Muster Roll

for *May & June*, 1864.

Present or absent *Absent*

Stoppage, \$ *100* for

Due Gov't, \$ *100* for

Valuation of horse, \$ *100*

Valuation of horse equipments, \$ *100*

Remarks: *On D.S. per S.O.
Hd. Qrs. 1st U.S.C.C.
June 29, 1864*

Book mark:

Perry

(358)

Copyist.

Of 1 Cav. U.S.C.T.

Timms Wilson

Pvt., Co. F, 1 Reg't U. S. Col'd Cavalry

Appears on a

Detachment Muster Roll

of the organization named above

for dated June 30, 1864.

Station In the Field

Present or absent Present

Stoppage, \$ 100 for

Due Gov't, \$ 100 for

Valuation of horse, \$ 100

Valuation of horse equipments, \$ 100

Remarks:

Book mark:

Hammer

(344)

Copyist.

N | **1 Cav.** | **U.S.C.T.**

Timmis Wilson

Pvt, Co. F, 1 Reg't U. S. Col'd Cavalry.

Appears on

Company Muster Roll

for *July Aug*, 1864.

Present or absent *Present*

Stoppage, \$ 100 for

Due Gov't, \$ 100 for

Valuation of horse, \$ 100

Valuation of horse equipments, \$ 100

Remarks:

Book mark:

(358)

Perry

Copyist.

W | **1 Cav. | U.S.C.T.**

Timus Wilson
Priv, Co. F, 1 Reg't U. S. Col'd Cavalry.

Appears on

Company Muster Roll

for *Alph + 000*, 1864.

Present or absent *Present*

Stoppage, \$ *100* for

Due Gov't, \$ *100* for

Valuation of horse, \$ *100*

Valuation of horse equipments, \$ *100*

Remarks:

Book mark: *...*

(358)

J. Leonard

Copyist.

21 | 1 Cav. | U.S.C.T.

James Wilson

Priv., Co. F, 1 Reg't U. S. Col'd Cavalry.

Appears on

Company Muster Roll

for Nov. 1864, 1864.

Present or absent Present

Stoppage, \$ 100 for

Due Gov't, \$ 100 for

Valuation of horse, \$ 100

Valuation of horse equipments, \$ 100

Remarks:

Book mark:

J. Leonard

(358)

Copyist.

24 | 1 Cav. | U.S.C.T.

Thomas Wilson

Priv., Co. F, 1 Reg't U. S. Col'd Cavalry.

Appears on

Company Muster Roll

for Jan & Feb, 1865.

Present or absent Present

Stoppage, \$ 100 for

Due Gov't, \$ 100 for

Valuation of horse, \$ 100

Valuation of horse equipments, \$ 100

Remarks:

Book mark:

J. W. [Signature]

(358)

Copyist.

W | **1 Cav.** | **U.S.C.T.**

Timus Wilson

Priv, Co. F, 1 Reg't U.S. Col'd Cavalry.

Appears on

Company Muster Roll

for *Mar. & Apr*, 1865.

Present or absent *Present*

Stoppage, \$ *100* for

Due Gov't, \$ *100* for

Valuation of horse, \$ *100*

Valuation of horse equipments, \$ *100*

Remarks:

Book mark:

J. M. Leonard

(358)

Copyist.

W | 1 Cav. | U.S.C.T.

Timus Wilson

Priv, Co. F, 1 Reg't U. S. Col'd Cavalry.

Appears on

Company Muster Roll

for *May & June*, 1865.

Present or absent *Present*

Stoppage, \$ *100* for

Due Gov't, \$ *100* for

Valuation of horse, \$ *100*

Valuation of horse equipments, \$ *100*

Remarks:

Book mark:

J. Leonard

(358)

Copyist.

H

1 Cav. U.S.C.T.

Timus Wilson

Priv

Co. F, 1 Reg't U. S. Col'd Cavalry.

Appears on

Company Muster Roll

for *July & Aug*, 1865.

Present or absent *Present*

Stoppage, \$ 100 for

Due Gov't, \$ 100 for

Valuation of horse, \$ 100

Valuation of horse equipments, \$ 100

Remarks:

Book mark:

J. Leonard

(358)

Copyist.

W. | 1 Cav. | U.S.C.T.

Timus Wilson

Priv, Co. F, 1 Reg't U. S. Col'd Cavalry.

Appears on

Company Muster Roll

for *Sept + Oct*, 1865.

Present or absent *Present.*

Stoppage, \$ *100* for

Due Gov't, \$ *100* for

Valuation of horse, \$ *100*

Valuation of horse equipments, \$ *100*

Remarks:

Book mark:

B. J. Cope

(358)

Copyist.

W. | 1 Cav. | U.S.C.T.

Timus Wilson
Cvt, Co. F, 1 Reg't U.S. Col'd Cavalry.

Appears on

Company Muster Roll

for *Nov. and Dec.*, 1860.

Present or absent *Present*

Stoppage, \$ 100 for

Due Gov't, \$ 100 for

Valuation of horse, \$ 100

Valuation of horse equipments, \$ 100

Remarks:

Book mark:

B. J. Clarke

(358)

Copyist.

W. | 1 Cav. | U.S.C.T.

Timus Wilson

Priv., Co. *F*, 1 Reg't U. S. Col'd Cavalry.

Appears on Co. Muster-out Roll, dated

Brazo Santiago Tex, Feb. 4, 1866.

Muster-out to date *Feb. 4*, 1866.

Last paid to *Aug. 31*, 1865.

Clothing account:

Last settled _____, 186 ; drawn since \$ _____ 100

Due soldier \$ *13*^{*26*}/₁₀₀; due U. S. \$ _____ 100

Am't for cloth'g in kind or money adv'd \$ _____ 100

Due U. S. for arms, equipments, &c., \$ _____ 100

Bounty paid \$ *None*/₁₀₀; due \$ *100*/₁₀₀

Remarks: *Joined at Orgl Ariz. Free before April 19th 61.*

Book mark: *2345/1880.*

(361)

B. J. Cooke

Copyist.

1501
Wilson, William

Co C, 1 U. S. Col'd Cav.

Personal papers herein.

Private

Private

CARD NUMBERS.

1	5303857	26	
2	5303929	27	
3	5304014	28	
4	5304100	29	
5	5304185	30	
6	5304271	31	
7	5304357	32	
8	5304472	33	
9	5305175	34	
10	9086002	35	
11	40725507	36	
12		37	
13		38	
14		39	
15		40	
16		41	
17		42	
18		43	
19		44	
20		45	
21		46	
22		47	
23		48	
24		49	
25		50	

Book Mark: V36 P40769. V10 P159
 68

See also

M | 1 Cav. | U.S.C.T.

William Wilson

Co. C, 1 Reg't U.S. Col'd Cav.

Appears on

Company Descriptive Book

of the organization named above.

DESCRIPTION.

Age 20 years; height 5 feet 3/4 inches.

Complexion TB each

Eyes; 1 black hair TB each

Where born Princess Ann Va

Occupation Farmer

ENLISTMENT.

When Dec 4/63

Where Norfolk Va

By whom Capt Brown; term 3 y'rs.

Remarks: Discharged on Surgeons Certificate at Norfolk Va on the 23rd day of Nov 1864

H. Conner

W. | *1 Cav.* | **U.S.C.T.**

William Wilson
Bt. Co. C, 1 Reg't U. S. Col'd Cav.

Age *22* years.

Appears on

Company Muster-in Roll

of the organization named above. Roll dated

Cp. Hammetton, Va., Dec 22, 1863.

Muster-in to date *Dec. 22, 1863.*

Joined for duty and enrolled:

When *Dec. 4*, 186*3*.

Where *Norfolk, Va.*

Period *3* years.

Valuation of horse, \$ *100*

Valuation of horse equipments, \$ *100*

Remarks :
.....
.....
.....
.....
.....

Book mark :
.....

Steele

W | **1 Cav. U.S.C.T.**

William Wilson

Priv, Co. C, 1 Reg't U. S. Col'd Cavalry.

Appears on

Company Muster Roll

for *Dec 22 to 31*, 186*3*.

Present or absent *Present*

Stoppage, \$ *100* for

Due Gov't, \$ *100* for

Valuation of horse, \$ *100*

Valuation of horse equipments, \$ *100*

Remarks:

Book mark:

A. Kerman

(358)

Copyist.

W

1 Cav. U.S.C.T.

William Wilson

Pvt, Co. C, 1 Reg't U. S. Col'd Cavalry.

Appears on

Company Muster Roll

for *Jan + Feb*, 1864.

Present or absent *Present*

Stoppage, \$ 100 for

Due Gov't, \$ 100 for

Valuation of horse, \$ 100

Valuation of horse equipments, \$ 100

Remarks:

Book mark: -----

A. Kerman

(358)

Copyist.

W | 1 Cav. | U.S.C.T.

William Wilson

Pat, Co. C, 1 Reg't U. S. Col'd Cavalry.

Appears on

Company Muster Roll

for *Mar + Apr*, 1864.

Present or absent *Present*

Stoppage, \$ 100 for

Due Gov't, \$ 100 for

Valuation of horse, \$ 100

Valuation of horse equipments, \$ 100

Remarks:

Book mark:

Afterman

(358)

Copyist.

W | 1 Cav. | U.S.C.T.

William Wilson

Pat, Co. C, 1 Reg't U. S. Col'd Cavalry.

Appears on

Company Muster Roll

for *May + June*, 1864.

Present or absent *Present*

Stoppage, \$ *100* for

Due Gov't, \$ *100* for

Valuation of horse, \$ *100*

Valuation of horse equipments, \$ *100*

Remarks: *On Daily Duty in Hospital.*

Book mark:

Ackerman

(358)

Copyist.

W

1 Cav.

U.S.C.T.

William Wilson

Pr, Co. C, 1 Reg't U. S. Col'd Cavalry.

Appears on

Company Muster Roll

for *July + Aug*, 1864.

Present or absent *Present*

Stoppage, \$ 100 for

Due Gov't, \$ 100 for

Valuation of horse, \$ 100

Valuation of horse equipments, \$ 100

Remarks:

Book mark :

Ackerman

(358)

Copyist.

W | 1 Cav. | U.S.C.T.

William Wilson

Priv, Co. C, 1 Reg't U. S. Col'd Cavalry.

Appears on

Company Muster Roll

for *Sept 9th (1864)*, 186*4*.

Present or absent *Present*

Stoppage, \$ *100* for

Due Gov't, \$ *100* for

Valuation of horse, \$ *100*

Valuation of horse equipments, \$ *100*

Remarks:

Book mark:

J. M. ...

(358)

Copyist.

N. | 1 Cav. | U.S.C.T.

William Wilson

Priv, Co. C, 1 Reg't U. S. Col'd Cavalry.

Appears on

Company Muster Roll

for *Nov. 4 Dec.*, 1864.

Present or absent

Stoppage, \$ 100 for

Due Gov't, \$ 100 for

Valuation of horse, \$ 100

Valuation of horse equipments, \$ 100

Remarks: *Discharge and final statement given*

Book mark:

(358) *J. McHance* Copyist.

W | 1 Cav. | U.S.C.T.

William Wilson

Co. D, 1 Reg't U. S. Colored Cav.

Appears on Returns as follows:

July 18 64 On duty duty
in camp

March 18 64 on duty in
QM Dept. Frankston

June 18 64 On duty duty
In hosp.

Nov 18 64 *Nov 23 Norfolk*
Discharged Army City

Book mark:

W. D. Patton

(546)

Copyist.

W | 1 Cav. | U.S.C.T.

Williams Wilson

Priv, Co. *C*, 1 Reg't U. S. Col'd Cavalry.

Appears on Co. Muster-out Roll, dated
Brazos Santiago Tex, Feb 4, 186 *6*.

Muster-out to date _____, 186 .

Last paid to _____, 186 .

Clothing account:

Last settled _____, 186 ; drawn since \$ _____ $\overline{100}$

Due soldier \$ _____ $\overline{100}$; due U. S. \$ _____ $\overline{100}$

Am't for cloth'g in kind or money adv'd \$ _____ $\overline{100}$

Due U. S. for arms, equipments, &c., \$ _____ $\overline{100}$

Bounty paid \$ _____ $\overline{100}$; due \$ _____ $\overline{100}$

Remarks: *Wounded at Crigtl Crp,*
Disch'd on Surgeons Certificate
at Norfolk Va, Nov 23 1864
Descriptive list furnished Nov
23, 1864.

Book mark: *v36 P407.67. v10 P159.68*

(361)

Lewis

Copyist.

Wilson, William

Art., Co. C, 1 Reg't U.S.C. Cav.

1 Enclosures.

Bed Cards	Descriptive Lists
Burial Records	Final Statements
Certs. of Dis. for Discharge /	Furloughs
C. M. Charges	Med. Des. Lists
Med. Certificates	Orders

Other papers relating to—

Admission to Hosp'l	Furlough
Casualty Sheet (Officer's)	Med. Examination
Confinement	Misc. Information
Contracts	Pay or Clothing
Death or Effects	Personal Reports
Desertions	Rank
Discharge from Hosp'l	Transfer to Hosp'l
Discharge from Service	Transfer to V. R. C.
Duty	Transportation

NOTE 1.

The company commander will here add a statement of all the facts known to him concerning the disease or wound, or cause of disability of the soldier; the time, place, manner, and all the circumstances under which the injury occurred, or disease originated or appeared; the duty, or service, or situation of the soldier at the time the injury was received or disease contracted, stating particularly whether the injury was received or the disease contracted in the line of his duty; and whatever other facts may aid a judgment as to the cause, immediate or remote, of the disability, and the circumstances attending it.

When the facts are not known to the company commander, the certificate of any officer, or affidavit of other person having such knowledge, will be appended—as the surgeon in charge of a hospital, the officer commanding a detachment of recruits, &c., &c.

NOTE 2.

When a probable case for pension, special care must be taken to state the degree of disability—as *1/2*, *3/4*, &c., &c.; to describe particularly the disability, wound, or disease; the extent to which it deprives him of the use of any limb or faculty, or affects his health, strength, activity, constitution, or capacity to labor or earn his subsistence. The surgeon will add, from his knowledge of the facts and circumstances, and from the evidence in the case, his professional opinion of the cause or origin of the disability. In the case of discharges by Medical Inspectors, the last paragraph will state that the "discharge was given by consent of the soldier, after a personal examination, and for disability, the nature, degree, and origin of which are correctly described in the within certificate."

Par. 1260 Regulations, Edit. 1861.

Medical officers, in giving certificates of disability, are to take particular care in all cases that have not been under their charge; and especially in epilepsy, convulsions, chronic rheumatism, derangement of the urinary organs, ophthalmia, ulcers, or any obscure disease liable to be feigned or purposely produced; and in no case shall such certificate be given until after sufficient time and examination to detect any attempt at deception.

DIRECTIONS.

This certificate will be made out in duplicate by the soldier's company commander, or other officer commanding the separate detachment to which he belongs, and sent by him to the surgeon who has charge of the hospital where the soldier is sick. The surgeon will then fill out and sign the surgeon's certificate, and forward these papers to the regimental, detachment, or post commander, who will forward them, with his action endorsed thereon, through the proper channel, to his division commander; or, if the troops are not attached to a division, to his corps, department, or other commander or officer to whom the authority to discharge enlisted men may be specially delegated.

These certificates, after having received the action of the highest authority to which they are required to be sent, will be returned through the same channel to the regimental, post, or detachment commander, who will, if the discharge is authorized by the endorsement of the proper authority, sign the soldier's discharge, and the last certificate on this paper; see that the soldier is furnished with the proper final statements in duplicate, and forward BOTH of these certificates direct to the Adjutant General United States Army, at Washington, D. C.; they will not, under any circumstances, be given into the hands of the soldier.

ADJUTANT GENERAL'S OFFICE

Dec 2nd 1864

Duplicate sent the Pension Office.

1864
 123
 W. G. R. of ...
 CERTIFICATE OF DISABILITY FOR DISCHARGE

IN THE CASE OF

William Wilson
 a Private Co. C
 First Reg't of U.S.C.C

Approved
 W. Buckley
 Surg. Major
 Ady. Med. Director

Head Quarters Dept. Va. & N. C.,
 ARMY OF THE JAMES,

In the Field, Nov. 20th 1864.

TO BE DISCHARGED

By command of Major General BUTLER:

Samuel Peck
 Aast. Adj. Gen.

Received (A. G. Office) 11 ... 1864

W. G. R.
 ADJUTANT GENERAL'S OFFICE

ARMY OF THE UNITED STATES
CERTIFICATE
OF DISABILITY FOR DISCHARGE.

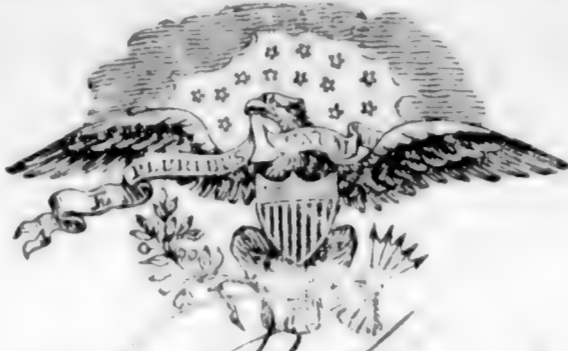

Private William Wilson, of Captain *Henry Sebus* Company, (.....) of the *First Colored* Regiment of United States Cavalry was enlisted by *Captain Brown* of the *1st Colored* Regiment of *U.S. Cav* at *Norfolk Va* on the *14th* day of *December*, 1863, to serve *Three* years; he was born in *Princess Anne* in the State of *Virginia*, is *Thirty* years of age, *Five* feet *Six* inches high, *Black* complexion, *Black* eyes, *Black* hair, and by occupation when enlisted a *Farmer*. During the last two months said soldier has been unfit for duty *60* days.* *By reason of rupture* *He has been unable to do but little service* *any mounted duty and but little service* *of any kind*

STATION: *Norfolk Va*
 DATE: *Nov 7th 1864*

Henry Sebus
 Captain
 Commanding Company.

I CERTIFY, that I have carefully examined the said *William Wilson* of Captain *Sebus* Company, and find him incapable of performing the duties of a soldier because of *double inguinal hernia that can not be retained by a truss - He has not been disabled in the service*

A. S. Mauley
 Surgeon.
 1st Lt. U.S. A.C.

DISCHARGED, this *23rd* day of *Nov*, 1864, at *Portsmouth Va*

Osgood
Brig Genl
 Commanding the Reg't

The Soldier desires to be addressed at
 Town _____ County _____ State _____

* See Note 1 on the back of this. † See Note 2 on the back of this.

1502
Wilson, William

Co G, 1 U. S. Col'd Cav.

Personal papers herein.

Private

Private

CARD NUMBERS.

1	5-309369	26
2	5-309438	27
8	5-309571	28
4	5-309607	29
5	5-300116	30
6	5-309644	31
7	5-310662	32
8	9086474	33
9	40725509	34
10		35
11		36
12		37
13		38
14		39
15		40
16		41
17		42
18		43
19		44
20		45
21		46
22		47
23		48
24		49
25		50

Book Mark: V13 P123.68. PV31 P208 74.

See also

W. | 1 Cav. | U.S.C.T.

William Wilson

....., Co. *G.*, 1 Reg't U.S. Col'd Cav.

Appears on

Company Descriptive Book

of the organization named above.

DESCRIPTION.

Age *26* years; height *5* feet *7* inches.

Complexion *Dark.*

Eyes; *Black* hair *Black.*

Where born *Norfolk, Va.*

Occupation *Farmer.*

ENLISTMENT.

When *Nov 30 - 1863.*

Where *Norfolk Va.*

By whom *Capt Brown*; term *3* y'rs.

Remarks:

.....

Dickerson

M

1 Cav. U.S.C.T.

William Wilson

Pri Co. G, 1 Reg't U. S. Col'd Cavalry.

Age 26 years.

Appears on

Company Muster-in Roll

of the organization named above. Roll dated

Camp Hamilton Va, Dec 22, 1863.

Muster-in to date Dec 22, 1863.

Joined for duty and enrolled:

When Nov 30, 1863

Where Norfolk Va

Period 3 years.

Valuation of horse, \$ 100

Valuation of horse equipments, \$ 100

Remarks:

Book mark:

Dannally

(356)

Copyist.

W | 1 Cav. | U.S.C.T.

William Wilson

Pvt, Co. G, 1 Reg't U. S. Col'd Cavalry.

Appears on

Company Muster Roll

for *Dec 22 to 31*, 186 *3*

Present or absent *Present*

Stoppage, \$ *100* for

Due Gov't, \$ *100* for

Valuation of horse, \$ *100*

Valuation of horse equipments, \$ *100*

Remarks:

Book mark:

Donnelly

(358)

Copyist.

W | 1 Cav. | U.S.C.T.

William Wilson

Pr, Co. G, 1 Reg't U. S. Col'd Cavalry.

Appears on

Company Muster Roll

for *Jan & Feb*, 186*4*.

Present or absent

Present

Stoppage, \$ 100 for

Due Gov't, \$ 100 for

Valuation of horse, \$ 100

Valuation of horse equipments, \$ 100

Remarks:

Book mark:

Donnelly

(358)

Copyist.

W | 1 Cav. | U.S.C.T.

William Wilson

Pn. , Co. G, 1 Reg't U. S. Col'd Cavalry.

Appears on

Company Muster Roll

for Mar & Apr, 1864

Present or absent Present

Stoppage, \$ 100 for

Due Gov't, \$ 100 for

Valuation of horse, \$ 100

Valuation of horse equipments, \$ 100

Remarks:

Book mark:

Donnelly

(358)

Copyist.

Dr 1 Cav. U.S.C.T.

Am Wilson

Pvt, Co., 1 Reg't U. S. Col'd Cavalry

Appears on a

Detachment Muster Roll

of the organization named above

for Mar. & April, 1864

Station Camp Hamilton, Va

Present or absent Present

Stoppage, \$ 100 for

Due Gov't, \$ 100 for

Valuation of horse, \$ 100

Valuation of horse equipments, \$ 100

Remarks :

Book mark :

Hammer

(344)

Copyist.

W | 1 Cav. | U.S.C.T.

William Wilson

Pr., Co. G, 1 Reg't U. S. Col'd Cavalry.

Appears on

Company Muster Roll

for May & June, 1864

Present or absent

Stoppage, \$ 100 for

Due Gov't, \$ 100 for

Valuation of horse, \$ 100

Valuation of horse equipments, \$ 100

Remarks: Due US for ordnance
lost 52 cents. DIED
June 13/64

Book mark:

Donnelly

(358)

Copyist.

W | 1 Cav. | U.S.C.T.

William Wilson

B, Co. *G*; 1 Reg't U. S. Colored Cav.

Appears on Returns as follows:

June 18 64 *June 13 64*
Bermuda Hundred
Va Died in Regt
Hospl

Book mark :

Wm. Wilson

(546)

Copyist.

H | 1 Cav. | U.S.C.T.

William Wilson

Priv, Co. *G*, 1 Reg't U. S. Col'd Cavalry.

Appears on Co. Muster-out Roll, dated

Mazos Santiago Tx, *Feb 4*, 1866.

Muster-out to date _____, 186 .

Last paid to _____, 186 .

Clothing account:

Last settled _____, 186 ; drawn since \$ _____ 100

Due soldier \$ _____ 100 ; due U. S. \$ _____ 100

Am't for cloth'g in kind or money adv'd \$ _____ 100

Due U. S. for arms, equipments, &c., \$ _____ 100

Bounty paid \$ _____ 100 ; due \$ _____ 100

Remarks: *Joined at Orgl Argy.*

Died of Diarrhea at Bermuda

Hundred Va. June 13/64. Final

Statement and inventory of

effects furnished June 30/64.

Book mark: *V13 P123, 68. PV31 P208*
74.

(361)

Mooy

Copyist.

Wilson, William

Pvt., Co. G, 1 Reg't *U.S.C. Cav.*

2 Enclosures.

Bed Cards	Descriptive Lists
Burial Records	Final Statements <i>2</i>
Certs. of Dis. for Discharge	Furloughs
C. M. Charges	Med. Des. Lists
Med. Certificates	Orders

Other papers relating to—

Admission to Hosp'l	Furlough
Casualty Sheet (Officer's)	Med. Examination
Confinement	Misc. Information
Contracts	Pay or Clothing
Death or Effects	Personal Reports
Desertions	Rank
Discharge from Hosp'l	Transfer to Hosp'l
Discharge from Service	Transfer to V. R. C.
Duty	Transportation

V

FINAL STATEMENT

OF

Private William Wilson Co. G.
1st
Reg't of Md. Colored Cavalry

VOLUNTEERS.

Died June 13, 1864

NOTE 1.—Two of these certificates (or duplicates) are to be given to each Volunteer Soldier or drafted man who may be discharged previously to the discharge of his company, that he may at once receive from the Paymaster the pay, &c., due him, and the captain or other COMMISSIONED officer commanding the company will certify to the act of the delivery of the duplicate certificates; on these certificates the Soldier is "entitled to" his discharge, and should also present his discharge to the Paymaster to have the payment endorsed on it. The discharge is to be given back to the Soldier by the Paymaster; the latter only retaining as his voucher the duplicate certificates.

NOTE 2.—If the Soldier is entitled to pay for the use of his horse, the Company Commander will certify to that fact on the back of both these final statements, and also to the time he has pay due for having been so mounted on his own horse.

NOTE 3.—When a Soldier is furnished with final statements, his descriptive list, if he has one, should be taken up by the officer who gives the Soldier these statements, and endorsed with a statement to this effect by the officer. This endorsement should exhibit a full statement of the time for which the Soldier was allowed pay on his final statements, the clothing account, and all other charges against him or in his favor, so as to comprise a complete exhibit of his account. It will then be transmitted to the company commander of the Soldier, who will enter all the data necessary to a full understanding of the Soldier's account on the muster roll upon which the Soldier's discharge is reported. The descriptive list will then be destroyed. The object of this is, that the remaining portion of the Soldier's account may be settled upon the receipt of these muster rolls, and the Soldier receive any pay or allowances that may be due him at the time of his discharge, and which may not appear on his final statements from the fact that his descriptive list is incomplete. These accounts for back pay, &c., are settled by the 2d Auditor of the Treasury Department.

NOTE 4.—Charges for loss or injury to ordnance, horse equipments, and other miscellaneous charges, should appear under the heading of "Other Stoppages."

NOTE 5.—Bounty paid by State authorities, and not by the United States, will not be entered on this statement.

NOTE 6.—Amounts due the Sutler and Laundress must be entered on the muster roll on which the discharge, death, desertion, &c., is reported, as well as on the final statement, otherwise the amount cannot be collected from the United States.

NOTE 7.—This blank will be used for deceased volunteers and drafted men, as well as for others.

NOTE 8.—Where a Soldier dies in Hospital or on detached service, his descriptive list, if he has one, should be sent with his final statements, in duplicate, to the Adjutant General, Washington, D. C.

Done
July 28, 1864
J. W. B.

Private William Wilson Died possessed of no effects

Done
July 12, 1864
J. W. B.

ADJUTANT GENERAL'S OFFICE.
July 28th 1864
Duplicate with Inventory sent 2d Auditor.

I certify, on honor, that William Wilson a Private of
 Captain W. H. Collins Company (A) of the 1st Regiment of Missouri
VOLUNTEERS, of the State of _____, born in Norfolk, State
 of Virginia, aged 26 years; 5 feet 7 inches high; Fair complexion,
Black eyes, Black hair, and by occupation a Farmer, having joined the company on
 its original organization at North, and enrolled in it at the muster into
 the service of the United States at _____, on the _____ day
 of December, 1862, (or was mustered in service as a recruit, by _____
 _____, at _____, on the _____ day of _____,
 186 , or was drafted and mustered into the service of the United States from the _____
 Enrollment District of the State of _____, at _____,
 on the _____ day of _____, 186 ,) to serve in the Regiment, for
 the term of Three Years: and having served **HONESTLY** and
FAITHFULLY with his Company in _____ to the present date, is now

entitled to a **DISCHARGE** by reason of Death (Caused by disease)
on the 13th day of June 1864 at Bermuda Hundred Va

The said Private William Wilson was last paid by Paymaster
Major _____ to include the 29th day of December, 1864, and has
 pay due him from that time to the present date; he is entitled to pay and subsistence for
TRAVELING to place of enrollment, and whatever other allowances are authorized to volunteer
 soldiers, drafted men, or militia, so discharged. He has received from the United States **CLOTHING**
 amounting to Twenty 100 dollars, since the _____ day of December,
 1863, when his clothing account was last settled. He has received from the United States
 _____ 100 dollars advanced **BOUNTY**.

There is to be stopped from him, on account of the State of United States, or other
 authorities, for **CLOTHING**, &c., received on entering service, _____ 100 dollars; and
 for other stoppages, viz: for one Remington Revolving Pistol used
for one pair of Shoes and Socks _____ Twenty 20 dollars.

He has been furnished with **TRANSPORTATION** in kind from the place of his discharge to
 _____; and he has been **SUBSISTED** for **TRAVELING** to his
 place of enrollment, up to the _____, 186 .

He is indebted to _____, **SUTLER**, _____ 100 dollars.
 He is indebted to _____, **LAUNDRESS**, _____ 100 dollars.

Given in Duplicate, at Bermuda Hundred Va, this 13th day
 of June, 1864.

William H. Collins
Captain

 Commanding Company.

FINAL STATEMENT

OF

Private William Wilson, Co. G

1st Reg't of U.S. Colored Cavalry

VOLUNTEERS.

NOTE 1.—Two of these certificates (or duplicates) are to be given to each Volunteer Soldier or drafted man who may be discharged previously to the discharge of his company, that he may at once receive from the Paymaster the pay, &c., due him, and the captain or other COMMISSIONED officer commanding the company will certify to the act of the delivery of the duplicate certificates; on these certificates the Soldier is "entitled to" his discharge, and should also present his discharge to the Paymaster to have the payment endorsed on it. The discharge is to be given back to the Soldier by the Paymaster; the latter only retaining as his voucher the duplicate certificates.

NOTE 2.—If the Soldier is entitled to pay for the use of his horse, the Company Commander will certify to that fact on the back of both these final statements, and also to the time he has pay due for having been so mounted on his own horse.

NOTE 3.—When a Soldier is furnished with final statements, his descriptive list, if he has one, should be taken up by the officer who gives the Soldier these statements, and endorsed with a statement to this effect by the officer. This endorsement should exhibit a full statement of the time for which the Soldier was allowed pay on his final statements, the clothing account, and all other charges against him or in his favor, so as to comprise a complete exhibit of his account. It will then be transmitted to the company commander of the Soldier, who will enter all the data necessary to a full understanding of the Soldier's account on the muster roll upon which the Soldier's discharge is reported. The descriptive list will then be destroyed. The object of this is, that the remaining portion of the Soldier's account may be settled upon the receipt of these muster rolls, and the Soldier receive any pay or allowances that may be due him at the time of his discharge, and which may not appear on his final statements from the fact that his descriptive list is incomplete. These accounts for back pay, &c., are settled by the 2d Auditor of the Treasury Department.

NOTE 4.—Charges for loss or injury to ordnance, horse equipments, and other miscellaneous charges, should appear under the heading of "Other Stoppages."

NOTE 5.—Bounty paid by State authorities, and not by the United States, will not be entered on this statement.

NOTE 6.—Amounts due the Sutler and Laundress must be entered on the muster roll on which the discharge, death, desertion, &c., is reported, as well as on the final statement, otherwise the amount cannot be collected from the United States.

NOTE 7.—This blank will be used for deceased volunteers and drafted men, as well as for others.

NOTE 8.—Where a Soldier dies in Hospital or on detached service, his descriptive list, if he has one, should be sent with his final statements, in duplicate, to the Adjutant General, Washington, D. C.

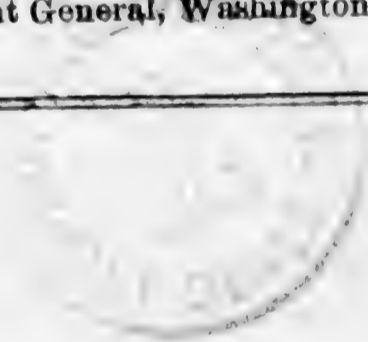

I certify, on honor, that William Wilson a Private of
 Captain William H. Collins Company (Co) of the First Regiment of U.S. Colored Cavalry
VOLUNTEERS, of the State of _____, born in Norfolk, State
 of Virginia, aged 26 years; 5' feet 7 inches high; Dark complexion,
Black eyes, Black hair, and by occupation a Farmer, having joined the company on
 its original organization at Norfolk Virginia, and enrolled in it at the muster into
 the service of the United States at Camp Hamilton Va, on the 22^d day
 of December, 1863, (or was mustered in service as a recruit, by _____
 _____, at _____, on the _____ day of _____,
 186 , or was drafted and mustered into the service of the United States from the _____
 Enrollment District of the State of _____, at _____,
 on the _____ day of _____, 186), to serve in the Regiment, for
 the term of three years: and having served **HONESTLY** and
FAITHFULLY with his Company in _____ to the present date, is now
 entitled to a **DISCHARGE** by reason of Death

The said Private William Wilson was last paid by Paymaster
Major Green to include the _____ day of January, 1864, and has
 pay due him from that time to the present date; he is entitled to pay and subsistence for
TRAVELING to place of enrollment, and whatever other allowances are authorized to volunteer
 soldiers, drafted men, or militia, so discharged. He has received from the United States **CLOTHING**
 amounting to \$ 210 $\frac{72}{100}$ dollars, since the 22^d day of December,
 1863, when his clothing account was last settled. He has received from the United States
 _____ $\frac{100}{100}$ dollars advanced **BOUNTY**.

There is to be stopped from him, on account of the State of United States, or other
 authorities, for **CLOTHING**, &c., received on entering service, _____ $\frac{100}{100}$ dollars; and
 for other stoppages, viz: for one Remington Revolving Pistol and for one
Pair of Spurs and Strap _____
 _____ (Total \$12) $\frac{52}{100}$ dollars.
 He has been furnished with **TRANSPORTATION** in kind from the place of his discharge to
 _____; and he has been **SUBSISTED** for **TRAVELING** to his
 place of enrollment, up to the _____, 186 .

He is indebted to _____, **SUTLER**, _____ $\frac{100}{100}$ dollars.
 He is indebted to _____, **LAUNDRESS**, _____ $\frac{100}{100}$ dollars.

Given in Duplicate, at Beverly Hundred Va, this 15th day
 of June, 1864.

William H. Collins
Captain

 Commanding Company.

[A. G. O. No. 95—First.]

Winburn ¹³⁰⁵ Robert

Co 16, 1 U. S. Col'd Cav.

Private

CARD NUMBERS.

1	26
2	27
3	28
4	29
5	30
6	31
7	32
8	33
9	34
10	35
11	36
12	37
13	38
14	39
15	40
16	41
17	42
18	43
19	44
20	45
21	46
22	47
23	48
24	49
25	50

See Winburn, Robert

Book Mark:

See also

1507
Winkfield Augustus

Co A, 1 U. S. Col'd Cav.

Bisate Bisate

CARD NUMBERS.

1	5310726	26
2	5310795	27
3	5310867	28
4	5310938	29
5	5311012	30
6	5311095	31
7	5311186	32
8	5311290	33
9	5311395	34
10	5311501	35
11	5311602	36
12	5311706	37
13	5311805	38
14	5311905	39
15	5312003	40
16	9086569	41
17		42
18		43
19		44
20		45
21		46
22		47
23		48
24		49
25		50

Book Mark: V88 P164.69

See also _____

N. | *1 Cav.* | **U.S.C.T.**

Augustus Winkfield
 _____, Co. *H*, *1* Reg't U. S. Col'd *Cav.*

Appears on

Company Descriptive Book

of the organization named above.

DESCRIPTION.

Age *18* years; height *5* feet *5* inches.

Complexion *Black.*

Eyes *Black*; hair *Black.*

Where born *Hanover V.*

Occupation _____

ENLISTMENT.

When *Dec. 12*, 186*3*.

Where *Norfolk.*

By whom *Capt Brown*; term *3* y'rs.

Remarks: _____

Dickerson.

1 Cav. | U.S.C.T.

John T. ...
..., Co. F, 1 Reg't U. S. Col'd Cavalry.

Age 10 years.

Appears on

> **Company Muster-in Roll**

of the organization named above. Roll dated

..., 1860.

Muster-in to date ..., 1860.

Joined for duty and enrolled:

When ..., 1860.

Where ...

Period ... years.

Valuation of horse, \$ 100

Valuation of horse equipments, \$ 100

Remarks:
.....
.....
.....
.....

Book mark:

(356)

...
Copyst.

1 Cav. U.S.C.T.

Lucas Winkler
Co. H, 1 Reg't U. S. Col'd Cavalry.

Appears on

Company Muster Roll

for Dec 31, 1863.

Present or absent Present

Stoppage, \$ 100 for

Due Gov't, \$ 100 for

Valuation of horse, \$ 100

Valuation of horse equipments, \$ 100

Remarks:

Book mark:

(358)

W. C. Edwards
Copyist.

Y | **1 Cav.** | **U.S.C.T.**

Augustus Springfield
Priv., Co. II, 1 Reg't U. S. Col'd Cavalry.

Appears on

Company Muster Roll

for *Jan 2*, 186*4*.

Present or absent *Present*

Stoppage, \$ *100* for

Due Gov't, \$ *100* for

Valuation of horse, \$ *100*

Valuation of horse equipments, \$ *100*

Remarks:

Book mark: -----

W. R. ...
(358) *W. R. ...* Copyist.

1 Cav. U.S.C.T.

James H. ...
..., Co. H, 1 Reg't U. S. Col'd Cavalry.

Appears on

Company Muster Roll

for *...*, 186*7*.

Present or absent *Present*

Stoppage, \$ 100 for

Due Gov't, \$ 100 for

Valuation of horse, \$ 100

Valuation of horse equipments, \$ 100

Remarks:

Book mark:

(358)

James H. ...

Copyist.

11/20 | **U.S.C.T.**

Present
11/20, Co. *4*, / Reg't U. S. Col'd. *11/20*

Appears on

Company Muster Roll

for *11/20*, 186*4*.

Present or absent *Present*

Stoppage, \$ *100* for

Due Gov't, \$ *100* for

Valuation of horse, \$ *100*

Valuation of horse equipments, \$ *100*

Remarks:

Book mark :

(358)

11/20
 Copyist.

1 Cav. U.S.C.T.

James M. ...

..., Co. H, 1 Reg't U. S. Col'd Cavalry.

Appears on

Company Muster Roll

for *...*, 1864.

Present or absent *Present*

Stoppage, \$ 100 for

Due Gov't, \$ 100 for

Valuation of horse, \$ 100

Valuation of horse equipments, \$ 100

Remarks:

Book mark:

(358)

...
Copyist.

A | 1 Cav. | U.S.C.T.

Augustus Kirkfield

Priv, Co. H, 1 Reg't U. S. Col'd Cavalry.

Appears on

Company Muster Roll

for *Sept & Oct*, 186*4*.

Present or absent *Present*

Stoppage, \$ *100* for

Due Gov't, \$ *100* for

Valuation of horse, \$ *100*

Valuation of horse equipments, \$ *100*

Remarks:
.....
.....
.....
.....
.....
.....
.....
.....
.....
.....

Book mark:

(358)

M Jackson
Copyist.

A | **1 Cav.** | **U.S.C.T.**

Augustus Pinkfield

Co., Co. H, 1 Reg't U. S. Col'd Cavalry.

Appears on

Company Muster Roll

for *Nov & Dec*, 186*2*

Present or absent *Present*

Stoppage, \$ *100* for

Due Gov't, \$ *100* for

Valuation of horse, \$ *100*

Valuation of horse equipments, \$ *100*

Remarks:

Book mark:

(358)

M Jackson
Copyist.

24 | 1 Cav. | U.S.C.T.

Augustus Hinkfield
Put, Co. H, 1 Reg't U. S. Col'd Cavalry.

Appears on

Company Muster Roll

for Jan & Feb, 1865.

Present or absent Present

Stoppage, \$ 100 for

Due Gov't, \$ 100 for

Valuation of horse, \$ 100

Valuation of horse equipments, \$ 100

Remarks:

Book mark:

(358)

O Jackson

Copyist.

27 | **1 Cav. | U.S.C.T.**

Augustus Springfield

Priv., Co. H, 1 Reg't U. S. Col'd Cavalry.

Appears on

Company Muster Roll

for *McNry Cpl*, 1860.

Present or absent *Present*

Stoppage, \$ 100 for

Due Gov't, \$ 100 for

Valuation of horse, \$ 100

Valuation of horse equipments, \$ 100

Remarks:
.....
.....
.....
.....
.....
.....
.....
.....
.....
.....

Book mark:

(358)

M Jackson
Copyist.

24 | *1. Cad* | U.S.C.T.

Augustus Pinkfield
Capt., Co. H, 1st Reg't U. S. Col'd. *Cad*

Appears on

Company Muster Roll

for *May June*, 186 *2*.

Present or absent *Present*

Stoppage, \$ *100* for

Due Gov't, \$ *100* for

Valuation of horse, \$ *100*

Valuation of horse equipments, \$ *100*

Remarks:

Book mark:

(358)

W. G. Jackson

Copyist.

2 | **1 Cav.** | **U.S.C.T.**

Augustus Pinkfield

Co., Co. H, 1 Reg't U. S. Col'd Cavalry.

Appears on

Company Muster Roll

for July + Aug, 1865.

Present or absent Present

Stoppage, \$ 100 for

Due Gov't, \$ 100 for

Valuation of horse, \$ 100

Valuation of horse equipments, \$ 100

Remarks:

Book mark:

(358)

M Jackson

Copyist.

W | 1 Cav. | U.S.C.T.

Gus Winkfield

Pt, Co. H, 1 Reg't U. S. Col'd Cavalry.

Appears on

Company Muster Roll

for Sept & Oct, 1865

Present or absent Present

Stoppage, \$ 100 for

Due Gov't, \$ 100 for

Valuation of horse, \$ 100

Valuation of horse equipments, \$ 100

Remarks:

Book mark:

J. Stewart

(358)

Copyist.

W | 1 Cav. | U.S.C.T.

Augustus Winkfield
Pte

Co. H, 1 Reg't U. S. Col'd Cavalry.

Appears on

Company Muster Roll

for *Nov & Dec*, 186*5*.

Present or absent *Present*

Stoppage, \$ *100* for

Due Gov't, \$ *100* for

Valuation of horse, \$ *100*

Valuation of horse equipments, \$ *100*

Remarks:

Book mark:

J. H. Stewart

(358)

Copyist.

W | 1 Cav. | U.S.C.T.

Augustus Winkfield
H, Co. K, 1 Reg't U. S. Col'd Cavalry.

Appears on Co. Muster-out Roll, dated
Brazos Santiago Tex Feb 4, 1866.

Muster-out to date Feb 4, 1866.

Last paid to Aug 31, 1865.

Clothing account:

Last settled _____, 186 ; drawn since \$ _____ 100

Due soldier \$ 7 ¹³/₁₀₀; due U. S. \$ _____ 100

Am't for cloth'g in kind or money adv'd \$ _____ 100

Due U. S. for arms, equipments, &c., \$ _____ 100

Bounty paid \$ _____ 100; due \$ _____ 100

Remarks: Joined at org org

Book mark: V 88 P 164, 69

(361) J. Stewart Copyist.

150

Whisley, Charles

Co E, 1 U. S. Col'd Cav.

Personal papers herein.

Private Private

CARD NUMBERS.

1	5306622	26
2	5306694	27
3	5306764	28
4	5306838	29
5	5306920	30
6	5307886	31
7	9086229	32
8	40725572	33
9		34
10		35
11		36
12		37
13		38
14		39
15		40
16		41
17		42
18		43
19		44
20		45
21		46
22		47
23		48
24		49
25		50

Book Mark: E13 Vol 8 P140

See also

N. | 1 Cav. | U.S.C.T.

Charles Winley

Co. *E.*, 1 Reg't U.S. Col'd Cav.

Appears on

Company Descriptive Book

of the organization named above.

DESCRIPTION.

Age *18* years; height *5* feet *3* inches.

Complexion *Blk.*

Eyes; *Blk.* hair *Blk.*

Where born *Hyde Co. N.C.*

Occupation *Farmer.*

ENLISTMENT.

When *Dec 12 - 1863*

Where *Ft Monroe Va.*

By whom *N.P. Pond*; term *3* y'rs.

Remarks: *Died May 6-64*
of wounds received
May 5-64 in
skirmish at Jones-
Bridge Va.

Dickerson.

H | 1 Cav. | U.S.C.T.

Charles Winsley

Pi, Co. E, 1 Reg't U. S. Col'd Cavalry.

Age *18* years.

Appears on

Company Muster-in Roll

of the organization named above. Roll dated

Camp Hamilton Va Dec 22, 186 *3*.

Muster-in to date *Dec 22*, 186 *3*.

Joined for duty and enrolled:

When *Dec 12*, 186 *3*.*

Where *Fort Monroe Va* *

Period *3* years.*

Valuation of horse, \$ 100

Valuation of horse equipments, \$ 100

Remarks :

*~~42~~ Muster-in roll shows enrollment of all men of this company as of same date and place. See enrollment on subsequent card or cards.

Book mark :

O. H. Moore

(856c)

(opysat.)

H | **1 Cav.** | **U.S.C.T.**

Charles Finley
Pr, Co. E, 1 Reg't U. S. Col'd Cavalry.

Appears on

Company Muster Roll

for *Dec 22 to Dec 31*, 186*3*.

Joined for duty and enrolled:

When *Dec 18*, 186*3*.*

Where *Fort Monroe Va**

Period *3* years.*

Present or absent *Present*

Stoppage, \$ *100* for

Due Gov't, \$ *100* for

Valuation of horse, \$ *100*

Valuation of horse equipments, \$ *100*

Remarks:

* See enrollment on card from muster-in roll.

Book mark:

J. H. Moore

H

1 Cav. | U.S.C.T.

Charles Shirley

Pvt, Co. E, 1 Reg't U. S. Col'd Cavalry.

Appears on

Company Muster Roll

for *Jan & Feb*, 1864.

Joined for duty and enrolled:

When *Dec 12*, 1863.*

Where *Fort Monroe Va**

Period *3* years.*

Present or absent *Present*

Stoppage, \$ *100* for

Due Gov't, \$ *100* for

Valuation of horse, \$ *100*

Valuation of horse equipments, \$ *100*

Remarks:

* See enrollment on card from muster-in roll.

Book mark:

P. H. Moore

22

1 Cav. U.S.C.T.

Charles Winley

Co. E, 1 Reg't U. S. Col'd Cavalry.

Appears on

Company Muster Roll

for March & April, 1864.

Joined for duty and enrolled:

When, 1864.*

Where Richmond Va.*

Period 3 years.*

Present or absent Present

Stoppage, \$ 100 for

Due Gov't, \$ 100 for

Valuation of horse, \$ 100

Valuation of horse equipments, \$ 100

Remarks:

* See enrollment on card from muster-in roll.

Book mark:

O. H. Winley

H | **1 Cav. | U.S.C.T.**

Charles Finley
FW, Co. E, 1 Reg't U. S. Col'd Cavalry.

Appears on

Company Muster Roll

for *May & June*, 1864.

Joined for duty and enrolled :

When *Dec 12*, 1863.*

Where *Fort Monroe Va* *

Period *3* years.*

Present or absent

Stoppage, \$ *100* for

Due Gov't, \$ *100* for

Valuation of horse, \$ *100*

Valuation of horse equipments, \$ *100*

Remarks: *Died of wounds*
May 6 Road near &
at New Ford in skirmish
with enemy

* See enrollment on card from muster-in roll.

Book mark :

J. W. Moore

11 | 1 Cav. | U.S.C.T.

Charles Wmiley

Priv, Co. *E*, 1 Reg't U. S. Colored Cav.

Appears on Returns as follows:

<i>May 1864</i>	<i>May 6/64</i>	
<i>Williamsburg Va.</i>	<i>Dead</i>	
<i>of wounds recd. in skirmish</i>		
<i>with enemy's inst.</i>		

Book mark :

Chas. Patton

(546)

Copyist.

W | 1 Cur | U.S.C.T.

Charles Wenzly

Priv, Co. E., 1 Reg't U. S. Col'd Cav

Appears on Co. Muster-out Roll, dated
Cruz, Santiago Texas, Feb 11, 1866.

Muster-out to date _____, 186 .

Last paid to _____, 186 .

Clothing account:

Last settled _____, 186 ; drawn since \$ _____ 100

Due soldier \$ _____ 100; due U. S. \$ _____ 100

Am't for cloth'g in kind or money adv'd \$ _____ 100

Due U. S. for arms, equipments, &c., \$ _____ 100

Bounty paid \$ _____ 100; due \$ _____ 100

Remarks: *Joined at org. org. Died
of wounds rec'd in battle May
6/64 at Williamsburg Va. final
statement and inventory of effects
forwarded Jim 1/64.*

Book mark: *Died of wounds rec'd in battle
(over)*

W. W. Allen

(361)

Copyist.

ARRA 329

JAN. - 6

5307886

1891 *

May 5/64. EB Vol 8, P140.

Wimley, Charles
 1st Co. E, 1 Reg't U.S.C. Cav.

2 Enclosures.

Bed Cards	Descriptive Lists
Burial Records	Final Statements
Certs. of Dis. for Discharge	Furloughs
C. M. Charges	Med. Des. Lists
Med. Certificates	Orders

Other papers relating to—

Admission to Hosp'l	Furlough
Casualty Sheet (Officer's) <i>1</i>	Med. Examination
Confinement	Misc. Information <i>2</i>
Contracts	Pay or Clothing
Death or Effects	Personal Reports
Desertions	Rank
Discharge from Hosp'l	Transfer to Hosp'l
Discharge from Service	Transfer to V. R. C.
Duty	Transportation

CASUALTY SHEET

Complete
No. 1

Charles Winley

Private of Company *E*

1st Regiment of *Infantry*

State Volunteers

NATURE OF CASUALTY

Died, May 6th 1864

*Wounded for Co. D. 1st
Aug 27 1862*

CASUALTY SHEET.

Name: *Charles Winley*
 Rank: *Private* Company: *E* Regiment: *1st*
 Arm: *U. S. Cav.* State: _____
 Nature of Casualty: *Death*

CAUSE OF CASUALTY—(NAME OF DISEASE, &C.)

*Wounds received at
 Jones Ford, Va. May 5th 1864*

DEGREE OF DISABILITY.

BY WHOM CERTIFIED.

*Chas. W. Emerson
 Capt. Co. "E." 1st U. S. Cav.*

DATE OF DISCHARGE, DEATH, &C.

May 6th 1864

PLACE OF DISCHARGE, DEATH, &C.

*Jones Ford
 near Charles City, Va.*

BY WHOM DISCHARGED.

FROM WHAT SOURCE THIS INFORMATION WAS OBTAINED.

*Company Muster Roll
 May & June, 1864.*

REMARKS.

*Company M. O. Roll states
 that he died as herein stated
 at Williamsburg, Va.*

John Powers

Clerk.

Surgeon General's Office,
Record and Pension Division,

Sept. 16, 1868.

Respectfully returned to the Adjutant General, U. S. Army, with certificate from records filed in this Office enclosed, in case of the soldier described within.

BY ORDER OF THE SURGEON GENERAL:

[Signature]
Bot. Lt. Col. and Asst. Surgeon, U. S. A.
(69)
R. of A., Vol. 111 No. 1111



1104
14

Adjutant General's Office,
Oct. 4th 1869.
E. 13 vol. 8. Page 140.
The Muster and Muster
and ROLL of G. E. 1st U. S.
Cavalry report the death
of Private Charles Hinkley
May 6th 1864.

The records of the Surgeon
General's Office indicate
that the said soldier may
5-1864.
The latter date May 15th
1864 is held to be correct
and the company and muster
out ROLL will be amended
accordingly.

[Signature]
St. Col. U. S. Army,
In charge 1st Div. Cav. Troops

[Signature]
In letter of
Oct 13th 69 to
2nd Army

WAR DEPARTMENT,

ADJUTANT GENERAL'S OFFICE,

WASHINGTON, *Aug 27th*, 1868.

SIR:

Final Statements in the cases of deceased soldiers are required to be sent to the Adjutant General's Office in duplicate, with one copy of the Inventory of Effects. The Descriptive List should also be sent to this Office in cases where the soldier was absent from his Company at the time of his death. Where there were no effects, it should be so stated on a blank Inventory, properly signed.

Certificates of Disability should be sent in duplicate. Special care should be taken that the date of discharge and signature of the discharging officer should be affixed.

As of the Final Statement *is on* Inventory, has been received in the case of *Pvt Charles Winley*, of Co. *"E"*, *1st* Regiment of *U.S. Col.* Volunteers, whose papers were forwarded to this Office. You will please forward the missing papers without delay.

I have the honor to be, sir,

He is reported on Co. Muster Roll as having died May 6th 1864 of wounds received at Jones Ford, Va. May 5th 1864. - Muster. out Roll states that his death occurred at Williamsburg. Va. Very respectfully,

Your obedient servant,

Thomas M. Vincent

Assistant Adjutant General.
(110)

~~COMMISSIONER GENERAL~~

Pvt Lieut Galt.

G. J. Woodward.

Asst Surg. U.S. Army.

Surgeon General's Office

Washington. D.C.

J. G. P.

Pension Number.....
R. of.....A., Vol. 14 No. 1454

WAR DEPARTMENT,
Surgeon General's Office,
RECORD AND PENSION DIVISION,

Washington, D. C., September 11, 1868.

[CERTIFICATE FROM RECORDS.]

It appears, from the records filed in this Office, that
..... Co....., Reg't..... Vol.....
was admitted to..... Hospital,.....
....., 186....., from..... for treatment for
.....
.....

It also appears, as reported by Asst. Surgeon M. H. Gray,
....., that Private Charles Windley, Co. C,
1st Reg't 4th U.S. Col. Cal. Vol. 29 was killed May 3rd, 1864, at
Jones Ford, near Charles City, Va., in a skirmish.

Remarks: No service papers can be furnished
by this office.

BY ORDER OF THE SURGEON GENERAL:

J. J. Crawford
.....
Brev. Lieut. Col. and Asst. Surgeon, U. S. Army.
(64)

(NOTE. This certificate should not be detached from the accompanying papers.)

1506

Winstar John

Co *B*, 1 U. S. Col'd Cav.

Private

Private

CARD NUMBERS.

1	5303081	26
2	5303191	27
3	5303294	28
4	5303395	29
5	5303493	30
6	5303589	31
7	5303677	32
8	5303764	33
9	9083940	34
10		35
11		36
12		37
13		38
14		39
15		40
16		41
17		42
18		43
19		44
20		45
21		46
22		47
23		48
24		49
25		50

Book Mark *744/84*

See also

A 1982831 POW-24
R. & P. 678845

J.B. Doud
Ex

N | 1 Cav. | U.S.C.T.

John Winston

....., Co. *B*, 1 Reg't U.S. Col'd Cav.

Appears on

Company Descriptive Book

of the organization named above.

DESCRIPTION.

Age *23* years; height *5* feet *11* inches.

Complexion *Black*

Eyes; *Black* hair *Black*

Where born *Nashville Tenn*

Occupation *Labourer*

ENLISTMENT.

When *Sept 15 - 64*

Where *Buffalo N.Y.*

By whom *Capt Rogers*; term *3* y'rs.

Remarks: *Bounty paid*

100.00 Clothing \$ 17.00

Extra \$ 7.50

Heaven

W | 1 Cav. | U.S.C.T.

John Winster

P, Co. B, 1 Reg't U. S. Col'd Cavalry.

Appears on

Company Muster Roll

for *Nov. + Dec.*, 186 *4*.

Present or absent *Present.*

Stoppage, \$ *100* for

Due Gov't, \$ *100* for

Valuation of horse, \$ *100*

Valuation of horse equipments, \$ *100*

Remarks: *Descriptive list not received.*

Book mark:

(358)

Stadock

Copyist.

24 | **1 Cav.** | **U.S.C.T.**

John Kingston

....., Co. B, 1 Reg't U. S. Col'd Cavalry.

Appears on

Company Muster Roll

for *Jan. & Feb.*, 1865.

Present or absent *Present.*

Stoppage, \$.....100 for

Due Gov't, \$.....100 for

Valuation of horse, \$.....100

Valuation of horse equipments, \$.....100

Remarks: *No Descriptive List received.*

Book mark:

(358) *Shadbolt* Copyist.

W | 1 Cav. | U.S.C.T.

John Winster

J, Co. B, 1 Reg't U. S. Col'd Cavalry.

Appears on

Company Muster Roll

for *Mar. & Apr.*, 1865.

Present or absent *Present*

Stoppage, \$ *100* for

Due Gov't, \$ *100* for

Valuation of horse, \$ *100*

Valuation of horse equipments, \$ *100*

Remarks: *Descriptive list not received.*

Book mark:

(358)

Gradholt

Copyist.

W | 1 Cav. | U.S.C.T.

John Kinstar
P

....., Co. B, 1 Reg't U. S. Col'd Cavalry.

Appears on

Company Muster Roll

for *May & June*, 1865.

Present or absent *Present*

Stoppage, \$.....100 for

Due Gov't, \$.....100 for

Valuation of horse, \$.....100

Valuation of horse equipments, \$.....100

Remarks: *No Descriptive list received.*

Joined company Nov. 25, 65

Book mark:

(358)

Shadolt

Copyist.

W | **1 Cav. | U.S.C.T.**

John Winstar
....., Co. B, 1 Reg't U. S. Col'd Cavalry.

Appears on

Company Muster Roll

for *July & Aug.*, 186*7*.

Present or absent *Present*

Stoppage, \$.....*100* for

Due Gov't, \$.....*100* for

Valuation of horse, \$.....*100*

Valuation of horse equipments, \$.....*100*

Remarks: *No. Descriptive list rec'd. joined Co. Nov. 25/64*

Book mark :

(358)

Shadock

Copyist.

W

1 Cav.

U.S.C.T.

John Winstan

Priv, Co. B, 1 Reg't U. S. Col'd Cavalry.

Appears on

Company Muster Roll

for *Sept Oct*, 1865.

Present or absent *present*

Stoppage, \$ *100* for

Due Gov't, \$ *100* for

Valuation of horse, \$ *100*

Valuation of horse equipments, \$ *100*

Remarks: *No descriptive list received*

Book mark:

Faulkner

(358)

Copyist.

21 | 1 Cav. | U.S.C.T.

John Minster

2nd, Co. B, 1 Reg't U. S. Col'd Cavalry.

Appears on

Company Muster Roll

for Nov 1864, 1865.

Present or absent present

Stoppage, \$ 100 for

Due Gov't, \$ 100 for

Valuation of horse, \$ 100

Valuation of horse equipments, \$ 100

Remarks:

(Enrolled & mustered in Sep. 15/64, at Buffalo, N.Y. for 3 yrs.)

Book mark:

Franklin

W | 1 Cav. | U.S.C.T.

John Winstar

Priv., Co. *B*, 1 Reg't U. S. Col'd Cavalry.

Appears on **Co. Muster-out Roll**, dated

Brazos Santiago Tex, *Feb 7*, 1866 .

Muster-out to date *Feb 7*, 1866 .

Last paid to *Not paid since enrollment*, 1866 .

Clothing account:

Last settled _____, 1866 ; drawn since \$ _____ 100

Due soldier \$ _____ 100; due U. S. \$ *28* ^{*99*} 100

Am't for cloth'g in kind or money adv'd \$ _____ 100

Due U. S. for arms, equipments, &c., \$ _____ 100

Bounty paid \$ _____ 100; due \$ _____ 100

Remarks: *Joined as Recruit*

Book mark: *744*, *84*

Frank Kne

(861)

Copyist.

Winstler John

....., Co., *61* Reg't *1st*

2 Enclosures.

Bed Cards	Final Statements
Burial Records	Furloughs or L. of A.
Certs. of Dis. for Discharge	Med. Certificates
C. M. Charges	Med. Des. Lists
Descriptive Lists	Orders
Discharge Certificates	Pris. of War Record
Enlistment Papers <i>2</i>	Resignations

Other papers relating to—

Admission to Hosp'l	Furlough or L. of A.
Casualty Sheet	Med. Examination
Confinement	Misc. Information
Contracts	Pay or Clothing
Death or Effects	Personal Reports
Desertion	Rank
Discharge from Hosp'l	Transfer to Hosp'l
Discharge from Service	Transfer to V. R. C.
Duty	Transportation

NOTE 1.—This blank will be used for both enlistments and re-enlistments—enlistment of veterans, &c., &c., in the volunteer service. They will be made out in duplicate in all cases—one to accompany the recruiting return of the superintendent (not the recruiting officer) to the Adjutant General, and one to accompany the accounts of the officer who pays bounty, &c. The Regiment and Company in which the soldier last served should be given on the back.

NOTE 2.—An enlistment holds to service. A muster-in must, in all cases, precede payment of pay, bounty, pension, &c. A muster-in roll must, in all cases, be filed in the Adjutant General's Office as evidence of muster-in. The mustering officer, commissary, or assistant commissary of musters, as the case may be, will countersign both enlistments as having mustered the soldier into the service of the United States before either of them is given to the disbursing officer.

DECLARATION OF RECRUIT.

I, *John Muster* desiring to VOLUNTEER as a Soldier in the **Army of the United States**, for the term of *Three* YEAR. Do Declare, That I am *Twenty three* years and *one* month of age; that I have never been discharged from the United States service on account of disability or by sentence of a court martial, or by order before the expiration of a term of enlistment; and I know of no impediment to my serving honestly and faithfully as a soldier for *Three* year

GIVEN at *Buffalo N.Y.* the *13* day of *Sept 1864*

Witness: *James McCabe* *John Muster*

940. Enlistments must in all cases be taken in triplicate. The recruiting officer will send one copy to the Second Auditor with his monthly accounts, a second to the Superintendent with his monthly return, and a third to the depot at the time the recruits are sent there. In cases of soldiers re-enlisted in a regiment, or of regimental recruits, the third copy of the enlistment will be sent at its date to regimental headquarters for file.

CREDITED TO			
State	District of Enrollment	County	Town
N. Y.			
			Ward

Discharged

Regt of

By *W. J. McCaskey*
6th & 8th Regiment of Col's Dragoons

Volunteered at

John Muster
Volunteered at Buffalo N.Y. Sept 13 1864

CONSENT IN CASE OF MINOR.

I, _____ of _____ the _____ said _____ is _____ years of age; and I do hereby freely give my CONSENT to his volunteering as a SOLDIER in the ARMY OF THE UNITED STATES for the period of _____ year

GIVEN at _____ the _____ day of _____

Witness:

Do CERTIFY, That I am _____; that the _____ years of age; and I

VOLUNTEER ENLISTMENT.

STATE OF
NEW YORK,

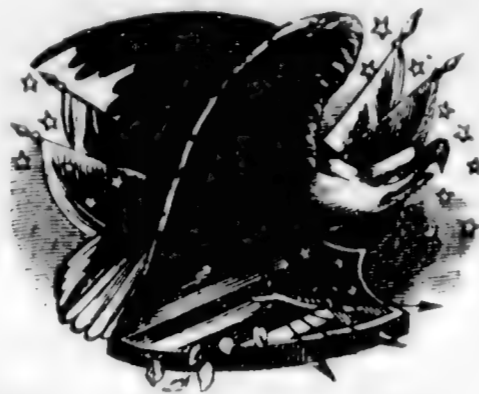

TOWN OF *Leicester*

30th Dist. Inf. Co

I, *John Nuister*, born in *Nashville*
in the State of *Tennessee*, aged *Twenty three* years,
and by occupation a *Laborer*, Do HEREBY ACKNOWLEDGE to have
volunteered this *Fifteenth* day of *Sept*, 1864,
to serve as a **Soldier** in the **Army of the United States of America**, for
the period of *Three* YEARS unless sooner discharged by proper authority.
Do also agree to accept such bounty, pay, rations and clothing as are, or may be,
established by law for volunteers. And I, *John Nuister*,
do solemnly swear, that I will bear true faith and allegiance to the **United States
of America**, and that I will serve them honestly and faithfully against all their
enemies or opposers whomsoever; and that I will observe and obey the orders of the
President of the United States, and the orders of the officers appointed over me, ac-
cording to the Rules and Articles of War.

Sworn and subscribed to, at Buffalo, N. Y.,

this *15* day of *Sept*, 1864.

BEFORE

W. K. Jones
Capt. & Provost Marshal 30th Dist. N. Y.

I CERTIFY, ON HONOR, That I have carefully examined the above-named Volunteer, agreeably
to the General Regulations of the Army, and that, in my opinion, he is free from all bodily defects and
mental infirmity, which would in any way disqualify him from performing the duties of a soldier.

Joseph H. Allen
30th Dist. Inf.
Examining Surgeon.

I CERTIFY, ON HONOR, That I have minutely inspected the Volunteer *John Nuister*
previously to his enlistment, and that he was entirely sober
when enlisted; that, to the best of my judgment and belief, he is of lawful age; and that, in accepting
him as duly qualified to perform the duties of an able-bodied soldier, I have strictly observed the Regu-
lations which govern the recruiting service. This soldier has *Black* eyes, *Black* hair,
Black complexion, is *5* feet *11* inches high.

W. K. Jones
Capt. & Provost Marshal 30th District, N. Y.,
Recruiting Officer.

(A. G. O. No. 74 & 76.)

Mustered into the service of the United States, for *Three* year or during the war, from date of enlistment, in Company
of *Co. 1st* Regiment of *Vol. 30th Dist. Inf.* on the *15* day of *Sept*, 1864, at *Leicester N.Y.*

W. K. Jones
Capt. & Provost Marshal 30th District, N. Y.,
Mustering Officer.

NOTE 1.—This blank will be used for both enlistments and re-enlistments—enlistment of veterans, &c., &c., in the volunteer service. They will be made out in duplicate in all cases—one to accompany the recruiting return of the superintendent (not the recruiting officer) to the Adjutant General, and one to accompany the accounts of the officer who pays bounty, &c. The Regiment and Company in which the soldier last served should be given on the back.

NOTE 2.—An enlistment holds to service. A muster-in must, in all cases, precede payment of pay, bounty, pension, &c. A muster-in roll must, in all cases, be filed in the Adjutant General's Office as evidence of muster-in. The mustering officer, commissary, or assistant commissary of musters, as the case may be, will countersign both enlistments as having mustered the soldier into the service of the United States before either of them is given to the disbursing officer.

DECLARATION OF RECRUIT.

I, John Huister desiring to VOLUNTEER as a Soldier in the **Army of the United States**, for the term of Three YEAR 1 Do Declare, That I am Twenty three years and One month of age: that I have never been discharged from the United States service on account of disability or by sentence of a court martial, or by order before the expiration of a term of enlistment; and I know of no impediment to my serving honestly and faithfully as a soldier for Three years

GIVEN at Buffalo N.Y. the 15 day of Sept, 1864

Witness: James McCabe John Huister
mark

No. 2291
John Huister
Volunteered at Buffalo N.Y.
Sept 13, 1864

By W. S. Regiment of Cavalry
enlistment: last served in Company

Discharged 18
Regt of

940. Enlistments must in all cases be taken in triplicate. The recruiting officer will send one copy to the Second Auditor with his monthly accounts, a second to the Superintendent with his monthly return, and a third to the depot at the time the recruits are sent there. In cases of soldiers re-enlisted in a regiment, or of regimental recruits, the third copy of the enlistment will be sent at its date to regimental headquarters for file.

CREDITED TO				
State	District of Enrollment	County	Town	Ward
N.Y.	<u>3rd</u>	<u> Erie</u>	<u>Lawrence</u>	

CONSENT IN CASE OF MINOR.

I, _____ of _____ years of age; and I do hereby freely give my CONSENT to his volunteering as a SOLDIER in the ARMY OF THE UNITED STATES for the period of _____ year

GIVEN at _____ the _____ day of _____

Witness:

Duplicate

VOLUNTEER ENLISTMENT.

STATE OF

TOWN OF *Laurel*

NEW YORK,

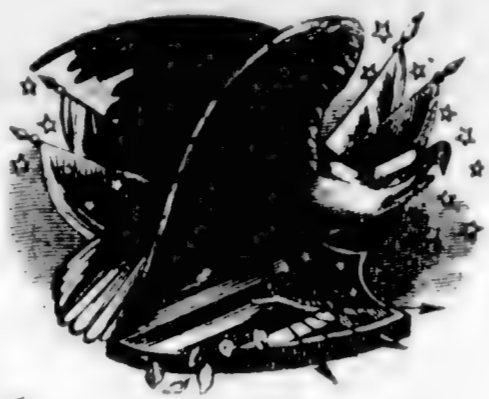

I, *John Muister*, born in *Nashville* in the State of *Tennessee*, aged *Twenty three* years, and by occupation a *Laborer*, Do HEREBY ACKNOWLEDGE to have volunteered this *Fifteenth* day of *Sept*, 1864, to serve as a **Soldier** in the **Army of the United States of America**, for the period of *Three* YEARS unless sooner discharged by proper authority. Do also agree to accept such bounty, pay, rations and clothing, as are or may be, established by law for volunteers. And I, *John Muister*, do solemnly swear, that I will bear true faith and allegiance to the **United States of America**, and that I will serve them honestly and faithfully against all their enemies or opposers whomsoever; and that I will observe and obey the orders of the President of the United States, and the orders of the officers appointed over me, according to the Rules and Articles of War.

Sworn and subscribed to, at Buffalo, N. Y.,

this *13* day of *Sept*, 1864,

BEFORE

Mark Rogers
Capt. & Provost Marshal 30th Dist. N. Y.

John Muister
mark

I CERTIFY, ON HONOR, That I have carefully examined the above-named Volunteer, agreeably to the General Regulations of the Army, and that, in my opinion, he is free from all bodily defects and mental infirmity, which would in any way disqualify him from performing the duties of a soldier.

Joseph T. Lewis
Sept 30th Dist N.Y.
Examining Surgeon.

I CERTIFY, ON HONOR, That I have minutely inspected the Volunteer *John Muister* previously to his enlistment, and that he was entirely sober when enlisted; that, to the best of my judgment and belief, he is of lawful age; and that, in accepting him as duly qualified to perform the duties of an able-bodied soldier, I have strictly observed the Regulations which govern the recruiting service. This soldier has *Black* eyes, *Black* hair, *Black* complexion, is *3* feet *11* inches high.

Mark Rogers
Capt. & Provost Marshal 30th District, N. Y.,
Recruiting Officer.

(A. G. O. No. 74 & 76.)

Mustered into the service of the United States, for *Three* years or during the war, from date of enlistment, in Company *D* of the *30th* Regiment of *Volunteers*, on the *15* day of *Sept*, 1864, at *Buffalo N.Y.*

Mark Rogers
Capt. & Provost Marshal 30th District, N. Y.,
Mustering Officer.

1507
Wise John

Co A, 1 U. S. Col'd Cav.
Personal papers herein.

Private Private

CARD NUMBERS.

1	5305243	26
2	5305312	27
3	5305387	28
4	5305464	29
5	5305540	30
6	5305616	31
7	5305720	32
8	5305810	33
9	5305929	34
10	5306044	35
11	5306147	36
12	5306244	37
13	5306344	38
14	5306439	39
15	5306530	40
16	9086094	41
17	40725513	42
18		43
19		44
20		45
21		46
22		47
23		48
24		49
25		50

Book Mark: _____

See also _____

N. | 1 Cav. | U.S.C.T.

John Wise.

....., Co. *D.*, 1 Reg't U.S. Col'd Cav.

Appears on

Company Descriptive Book

of the organization named above.

DESCRIPTION.

Age *21* years; height *5* feet *6* inches.

Complexion *Dark.*

Eyes; *Dark* hair *Dark.*

Where born *Mathis Co Va.*

Occupation *Labourer.*

ENLISTMENT.

When *Dec 5/68*

Where *Roanoke Va*

By whom *Capt Brown*; term *3* y'rs.

Remarks:

.....

.....

.....

.....

.....

.....

.....

.....

.....

.....

.....

.....

.....

.....

.....

.....

.....

.....

.....

.....

.....

.....

.....

.....

.....

.....

.....

.....

.....

.....

.....

.....

.....

.....

.....

.....

.....

.....

.....

.....

.....

.....

Dickerson.

(383g)

Copyst.

W | **1 Cav.** | **U.S.C.T.**

John Wise

Bt, Co. *D*, 1 Reg't U. S. Col'd Cavalry.

Age *21* years.

Appears on

Company Muster-in Roll

of the organization named above. Roll dated

Camp Hamilton Va, *Dec 22*, 1863.

Muster-in to date *Dec 22*, 1863.

Joined for duty and enrolled:

When *Dec 20*, 1863.

Where *Norfolk Va*

Period *3* years.

Valuation of horse, \$ 100

Valuation of horse equipments, \$ 100

Remarks:

Book mark:-----

E. B. Thompson

(356)

Copyist.

M | 1 Cav. | U.S.C.T.

John Wiso

Plt, Co. D, 1 Reg't U. S. Col'd Cavalry.

Appears on

Company Muster Roll

for *from Dec 22 to Dec 31*, 1863.

Present or absent *Present*

Stoppage, \$ *100* for

Due Gov't, \$ *100* for

Valuation of horse, \$ *100*

Valuation of horse equipments, \$ *100*

Remarks:

Book mark:

E. B. Thompson
Copyist.

(358)

W | 1 Cav. | U.S.C.T.

John Wise

Pvt, Co. D, 1 Reg't U. S. Col'd Cavalry.

Appears on

Company Muster Roll

for *Jan & Feb.*, 186*1*.

Present or absent *Present*

Stoppage, \$ *100* for

Due Gov't, \$ *100* for

Valuation of horse, \$ *100*

Valuation of horse equipments, \$ *100*

Remarks:

Book mark:

E. B. Thompson

(358)

Copyist.

W

1 Cav.

U.S.C.T.

John Wise

Plt, Co. D, 1 Reg't U. S. Col'd Cavalry.

Appears on

Company Muster Roll

for *Mch & Apr*, 186*1*.

Present or absent *Present*

Stoppage, \$ *100* for

Due Gov't, \$ *100* for

Valuation of horse, \$ *100*

Valuation of horse equipments, \$ *100*

Remarks:

Book mark:

E. B. Thompson
Copyist.

(358)

W | 1 Cav. | U.S.C.T.

John Wise

Plt, Co. D, 1 Reg't U. S. Col'd Cavalry.

Appears on

Company Muster Roll

for *May & June*, 1864.

Present or absent *Present*

Stoppage, \$ *100* for

Due Gov't, \$ *100* for

Valuation of horse, \$ *100*

Valuation of horse equipments, \$ *100*

Remarks:

.....
.....
.....
.....
.....
.....
.....
.....

Book mark: ***

E. B. Thompson

(358)

Copyist.

W | 1 Cav. | U.S.C.T.

John Wise

Plt., Co. D, 1 Reg't U. S. Col'd Cavalry.

Appears on

Company Muster Roll

for July & Aug, 1864.

Present or absent Present

Stoppage, \$ 100 for

Due Gov't, \$ 100 for

Valuation of horse, \$ 100

Valuation of horse equipments, \$ 100

Remarks:

Book mark:

E. B. Thompson

(358)

Copyist.

H | 1 Cav. | U.S.C.T.

Arthur Rice

Co. D, Co. D, 1 Reg't U. S. Col'd Cavalry.

Appears on

Company Muster Roll

for *Sept 2001*, 186*1*.

Present or absent *Present*

Stoppage, \$ *100* for

Due Gov't, \$ *100* for

Valuation of horse, \$ *100*

Valuation of horse equipments, \$ *100*

Remarks:

Book mark:

(358)

Thomas

Copyist.

7 | 1 Cav. | U.S.C.T.

John Rice

Co. D, Co. D, 1 Reg't U. S. Col'd Cavalry.

Appears on

Company Muster Roll

for Nov - Dec, 1864.

Present or absent Present

Stoppage, \$ 100 for

Due Gov't, \$ 100 for

Valuation of horse, \$ 100

Valuation of horse equipments, \$ 100

Remarks:

Book mark: -----

John Rice

7 | 1 Cav. | U.S.C.T.

John Hise
Col, Co. D, 1 Reg't U. S. Col'd Cavalry.

Appears on

Company Muster Roll

for *Army*, 186*5*.

Present or absent *Present*

Stoppage, \$ *100* for

Due Gov't, \$ *100* for

Valuation of horse, \$ *100*

Valuation of horse equipments, \$ *100*

Remarks:

Book mark:

(358)

Chambers

Copyist.

H | 1 Cav. | U.S.C.T.

John Wise

Co, Co. D, 1 Reg't U. S. Col'd Cavalry.

Appears on

Company Muster Roll

for *Mar Sapie*, 1865.

Present or absent *Present*

Stoppage, \$ *100* for

Due Gov't, \$ *100* for

Valuation of horse, \$ *100*

Valuation of horse equipments, \$ *100*

Remarks:

Book mark:

(358)

Abrams

Copyist.

A | 1 Cav. | U.S.C.T.

John Rice

Plt, Co. D, 1 Reg't U. S. Col'd Cavalry.

Appears on

Company Muster Roll

for *May & June*, 186*4*.

Present or absent *Present*

Stoppage, \$ *100* for

Due Gov't, \$ *100* for

Valuation of horse, \$ *100*

Valuation of horse equipments, \$ *100*

Remarks:

Book mark:

W. Brown

77

1 Cav.

U.S.C.T.

Abner Rice

Pat, Co. D, 1 Reg't U. S. Col'd Cavalry.

Appears on

Company Muster Roll

for *Arley Young*, 1865.

Present or absent *Present*

Stoppage, \$ 100 for

Due Gov't, \$ 100 for

Valuation of horse, \$ 100

Valuation of horse equipments, \$ 100

Remarks:

Book mark:

L. D. ...

(358)

Copyist.

H

1 Cav. U.S.C.T.

John Wise

Priv., Co. D, 1 Reg't U. S. Co'd Cavalry.

Appears on

Company Muster Roll

for *Sept. & Oct.*, 1865.

Present or absent *Present*

Stoppage, \$ *100* for

Due Gov't, \$ *100* for

Valuation of horse, \$ *100*

Valuation of horse equipments, \$ *100*

Remarks:

Book mark:

R. E. Wilson

(358)

Copyist.

H | 1 Cav. | U.S.C.T.

John Wise

Priv., Co. D, 1 Reg't U. S. Col'd Cavalry.

Appears on

Company Muster Roll

for *Nov. & Dec.*, 186*5*.

Present or absent *Absent*

Stoppage, \$ *100* for

Due Gov't, \$ *100* for

Valuation of horse, \$ *100*

Valuation of horse equipments, \$ *100*

Remarks: *On detached duty pr. Sp. Ord. No. 99. Octo 9-1865- in Post R.M.D.*

Book mark:

R. E. Wilson

(358)

Copyist.

W. | 1 Cav. | U.S.C.T.

Com Wise

Pr, Co. D, 1 Reg't U. S. Colored Cav.

Appears on Returns as follows:

Oct. Dec 1863. absent
D.C. S.O. No 49 Oct 9/63
in 2nd Regt

Book mark:

Chas Patton

(546)

Copyist.

W | **1 Cav.** | **U.S.C.T.**

John Wise

Chi., Co. *D*, 1 Reg't U. S. Col'd Cavalry.

Appears on **Co. Muster-out Roll**, dated

Brazos Santiago, Tex., *Feb. 4*, 186*6*.

Muster-out to date *Feb. 4*, 186*6*.

Last paid to *Aug. 31*, 186*5*.

Clothing account:

Last settled....., 186 ; drawn since \$..... $\overline{100}$

Due soldier \$..... $\overline{100}$; due U. S. \$..... $13 \frac{22}{100}$

Am't for cloth'g in kind or money adv'd \$..... $\overline{100}$

Due U. S. for arms, equipments, &c., \$..... $\overline{100}$

Bounty paid \$..... $\overline{100}$; due \$..... $\overline{100}$

Remarks: *Joined at orig. reg.*

Book mark :

H. C. Wilson

(361)

Copyist.

1508
Whitby Joseph

Co *of*, 1 U.S. Col'd Cav.

Private

CARD NUMBERS.

1	26
2	27
3	28
4	29
5	30
6	31
7	32
8	33
9	34
10	35
11	36
12	37
13	38
14	39
15	40
16	41
17	42
18	43
19	44
20	45
21	46
22	47
23	48
24	49
25	50

See Whitby, Joseph

Book Mark:

See also

Wood 1509 Daphne

Co- , 1 U. S. Col'd Cav.

CARD NUMBERS.

1	5300047	26
2		27
3		28
4		29
5		30
6		31
7		32
8		33
9		34
10		35
11		36
12		37
13		38
14		39
15		40
16		41
17		42
18		43
19		44
20		45
21		46
22		47
23		48
24		49
25		50

Book Mark:

See also

H | *1. Cav.* **U.S.C.T.**

Naphu Wood

....., Co....., Reg't U. S. Col'd

Appears on **Hospital Muster Roll**

of *1* Reg't U. S. Col'd *Cav.*

for *Jan + Feb.* 186*7*

When attached to Hosp. *Nov 30* 1864.

How employed *Matron*

Present or absent.....

Remarks: *Discharged from Hospital Dec 31/64*

Name not taken up in rolls of Regt

Book mark :

(343)

Somers

Copyist.

1510

Wood Frederick

Co *F*, 1 U. S. Col'd Cav.

Personal papers herein.

Private | *Private*

CARD NUMBERS.

1	5307946	26
2	5308015	27
3	5308097	28
4	5308188	29
5	5300115	30
6	5308270	31
7	5308367	32
8	5309292	33
9	9086346	34
10	W-4-05-1872	35
11	32526314	36
12	40725574	37
13		38
14		39
15		40
16		41
17		42
18		43
19		44
20		45
21		46
22		47
23		48
24		49
25		50

Book Mark *C. 13. V. 10. P. 7. V. 123 P. 418. VII P. 97. 68.*
W. 4. V. 9 C. 5. 1842. 76. 049 77 13V

See also

N. | 1 Cav. | U.S.C.T.

Fredrick Wood.

....., Co. *F*....., 1 Reg't U.S. Col'd Cav.

Appears on

Company Descriptive Book

of the organization named above.

DESCRIPTION.

Age *30* years; height *5* feet *8* inches.

Complexion *Black.*

Eyes; *Black* hair *wooly.*

Where born *Norfolk, Va.*

Occupation *Servt.*

ENLISTMENT.

When *Dec 11-63.*

Where *Norfolk.*

By whom *Capt Brown*; term *3* y'rs.

Remarks: *Died in Hampton*

Hospital Jan 5-1864.

Dickerson.

N | 1 Cav. | U.S.C.T.

Fredrick Wood

Priv, Co. *F*, 1 Reg't U. S. Col'd Cavalry.

Age *43* years.

Appears on

Company Muster-in Roll

of the organization named above. Roll dated

Camp Hamilton Va, Dec. 22, 1863.

Muster-in to date *Dec. 22, 1863.*

Joined for duty and enrolled:

When *Dec. 10*, 1863.

Where *Norfolk, Va,*

Period *3* years.

Valuation of horse, \$ 100

Valuation of horse equipments, \$ 100

Remarks: _____

Book mark: _____

(356)

Perry

Copyist.

W. | **1 Cav.** | **U.S.C.T.**

Fredrick Wood

Pr, Co. F, 1 Reg't U. S. Col'd Cavalry.

Appears on

Company Muster Roll

for *22 Dec to 31 Dec*, 1863.

Present or absent *Present*

Stoppage, \$ *100* for

Due Gov't, \$ *100* for

Valuation of horse, \$ *100*

Valuation of horse equipments, \$ *100*

Remarks:

Book mark:

Perry

(358)

Copyist.

A | 1 Cav. | U.S.C.T.

By
Frederick Hood

Pvt, Co. F, 1 Reg't U. S. Col'd Cavalry.

Appears on

Company Muster Roll

for *Jan & Feb.*, 1864.

Present or absent *Present*

Stoppage, \$ 100 for

Due Gov't, \$ 100 for

Valuation of horse, \$ 100

Valuation of horse equipments, \$ 100

Remarks:

Book mark: -----

(358)

Perry

Copyist.

A | 1 Cav. | U.S.C.T.

Frederick Wood
Prvt, Co. F, 1 Reg't U. S. Col'd Cavalry.

Appears on

Company Muster Roll

for *March & April*, 1864.

Present or absent *Present*

Stoppage, \$ *100* for

Due Gov't, \$ *100* for

Valuation of horse, \$ *100*

Valuation of horse equipments, \$ *100*

Remarks:

Entry cancelled by line

Book mark:

Perry

(358)

Copyist.

Pl 1 Cav, U.S.C.T.

Ford Wood

But, Co., 1 Reg't U. S. Col'd Cavalry

Appears on a

Detachment Muster Roll

of the organization named above

for Mar & April, 1864

Station Camp Hamilton, Va

Present or absent Present

Stoppage, \$ 100 for

Due Gov't, \$ 100 for

Valuation of horse, \$ 100

Valuation of horse equipments, \$ 100

Remarks :

Book mark :

(344)

Hammer

Copyist.

W. | 1 Cav. | U.S.C.T.

Frederick Wood
 Priv, Co. F, 1 Reg't U.S.C.Cav.

Appears on

Hospital Muster Roll

of U. S. A. General Hospital,

at Hampton, Va.,

for Mar. & Apr., 1864.

Attached to hospital:

When, 186 .

How employed.....

Last paid by Maj.....

to, 186 .

Bounty paid \$ 100; due \$ 100

Present or absent Present

Remarks: No Descriptive List

Book mark :

Sitler

A | 1 Cav. | U.S.C.T.

Frederick Wood

Co. F, Co. F, 1 Reg't U. S. Col'd Cavalry.

Appears on

Company Muster Roll

for *May & June*, 1864.

Present or absent *Absent*

Stoppage, \$ *100* for

Due Gov't, \$ *100* for

Valuation of horse, \$ *100*

Valuation of horse equipments, \$ *100*

Remarks: *Sick in Chesapeake Hospital Fort Mifflin. Lost one set horse equipments*

Book mark:

Perry

(358)

Copyist.

A | **1 Cav.** | **U.S.C.T.**

Fredrick Wood

Pvt, Co. F, 1 Reg't U. S. Col'd Cavalry.

Appears on

Company Muster Roll

for *July & Aug*, 1864.

Present or absent

Stoppage, \$ 100 for

Due Gov't, \$ 100 for

Valuation of horse, \$ 100

Valuation of horse equipments, \$ 100

Remarks: *Died June 6*
1864, Hampton Hos-
pital. Due U.S. one
set Horse equip-
ments.

Book mark: *Died June 6*

Perry

(358)

Copyist.

M | 1 Cav. | U.S.C.T.

Fred Woods

Pr, Co. G, 1 Reg't U. S. Colored Cav.

Appears on Returns as follows:

June 1864 Absent
sick in Chesapeake
Hospl.

Aug 1864 June 5. 1864
Hampton Va Sick
in Hampton Hospl.

Book mark :

Chas. Butler

W. | 1 Cav. | U.S.C.T.

Frederick Wood
Priv., Co. *F*, 1 Reg't U. S. Col'd Cavalry.

Appears on Co. Muster-out Roll, dated
Prozas Santiago, Tex, Feb. 4, 1866.

Muster-out to date _____, 186 .

Last paid to _____, 186 .

Clothing account:

Last settled _____, 186 ; drawn since \$ _____ 100

Due soldier \$ _____ 100; due U. S. \$ _____ 100

Am't for cloth'g in kind or money adv'd \$ _____ 100

Due U. S. for arms, equipments, &c., \$ _____ 100

Bounty paid \$ _____ 100; due \$ _____ 100

Remarks: *Joined at Crig. Ariz.*
Dies June 5" 64 Hampton Hosp.
79. Cause: Inflammation of
Spinal Cord. Description List
furnished Jan. 5" 64

Book mark: *21230 418, 71, VIII 97, 68, 71, 4, 25-*
-9, C. T. 1872. 76, 549 17 BN

B. J. Cooke

(861)

Copyist.

W 1 Cav use 7

Frederick Hood

, Co. F, 1 Reg't US Caval

NOTATION.

Book mark: *W-4 C. J 1872*

Record and Pension Office,

WAR DEPARTMENT.

This book mark refers only to a report from the medical records, made by the Surgeon General to the Adjutant General, relative to the above-named man. As the medical records have since been carded, no transcript of this report is made hereon.

J. Evans

(491)

Copyist.

Wood, Frederick

P. Co. J. 1

Reg't W. Co.

Enclosures.

Bed Cards	Descriptive Lists
Burial Records	Final Statements /
Certs. of Dis. for Discharge	Furloughs
C. M. Charges	Med. Des. Lists
Med. Certificates	Orders

Other papers relating to—

Admission to Hosp'l	Furlough
Casualty Sheet (Officer's)	Med. Examination
Confinement	Misc. Information
Contracts	Pay or Clothing
Death or Effects	Personal Reports
Desertions	Rank
Discharge from Hosp'l	Transfer to Hosp'l
Discharge from Service	Transfer to V. R. C.
Duty	Transportation

*Adj. Gen. 29th 1864
Copy of effects sent 2d Auditor
A.G.C. June 20 1864
H.C.'s acct. for effects sent
2d Auditor p. 3.*

FINAL STATEMENT

OF
Private Frederick Wood
1st Reg't of *U.S. Col'd Cavalry*

VOLUNTEERS.

June 15 1864

NOTE 1.—Two of these certificates (or duplicates) are to be given to each Volunteer Soldier or drafted man who may be discharged previously to the discharge of his company, that he may at once receive from the Paymaster the pay, &c., due him, and the captain or other COMMISSIONED officer commanding the company will certify to the act of the delivery of the duplicate certificates; on these certificates the Soldier is "entitled to" his discharge, and should also present his discharge to the Paymaster to have the payment endorsed on it. The discharge is to be given back to the Soldier by the Paymaster; the latter only retaining as his voucher the duplicate certificates.

NOTE 2.—If the Soldier is entitled to pay for the use of his horse, the Company Commander will certify to that fact on the back of both these final statements, and also to the time he has pay due for having been so mounted on his own horse.

NOTE 3.—When a Soldier is furnished with final statements, his descriptive list, if he has one, should be taken up by the officer who gives the Soldier these statements, and endorsed with a statement to this effect by the officer. This endorsement should exhibit a full statement of the time for which the Soldier was allowed pay on his final statements, the clothing account, and all other charges against him or in his favor, so as to comprise a complete exhibit of his account. It will then be transmitted to the Company Commander of the Soldier, who will enter all the data necessary to a full understanding of the Soldier's account on the muster roll upon which the Soldier's discharge is reported. The descriptive list will then be destroyed. The object of this is, that the remaining portion of the Soldier's account may be settled upon the receipt of these muster rolls, and the Soldier receive any pay or allowances that may be due him at the time of his discharge, and which may not appear on his final statements from the fact that his descriptive list is incomplete. These accounts for back pay, &c., are settled by the 2d Auditor of the Treasury Department.

NOTE 4.—Charges for loss or injury to ordnance, horse equipments, and other miscellaneous charges, should appear under the heading of "Other Stoppages."

NOTE 5.—Bounty paid by State authorities, and not by the United States, will not be entered on this statement.

NOTE 6.—Amounts due the Sutler and Laundress must be entered on the muster roll on which the discharge, death, desertion, &c., is reported, as well as on the final statement, otherwise the amount cannot be collected from the United States.

NOTE 7.—This blank will be used for deceased volunteers and drafted men, as well as for others.

NOTE 8.—Where a Soldier dies in hospital or on detached service, his descriptive list, if he has one, should be sent with his final statements, in duplicate, to the Adjutant General, Washington, D. C.

ADJUTANT GENERAL'S OFFICE.

Sept 13th 1864

Duplicate with Inventory sent 2d Auditor.

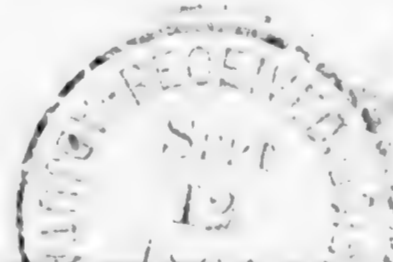

Adjutant General Office

Washington January 11th 1872.

The Muster-Roll of Co. F. 1st

U. S. Colored Cavalry for July & August 1864 and the Final Statement of Private *Frederick Wood* - report respectively date of his death - *June 5th* and *16th 1864*. - Company Muster-out Roll and report from Surgeon General U. S. Army - *June 5th 1864*.

The latter date (*June 5th 1864*)

is held to be correct and the Company Muster-Roll for July & August 1864 and the soldiers Final Statement, will be amended accordingly

Anna M. [Signature]

Assistant Adjutant General

Equal Noted

H. H.

See letter of January 26th '72 to Second Auditor

I certify, on honor, that Fredrick Wood a Private of
 Captain Chas. Schwarz Company (F) of the First Regiment of U.S. Col'd Cavalry
VOLUNTEERS, of the State of _____, born in Norfolk Va, State
 of Virginia, aged 43 years; 5 feet 7 inches high; Black complexion,
Black eyes, Woolly hair, and by occupation a Servant, having joined the company on
 its original organization at Norfolk Va, and enrolled in it at the muster into
 the service of the United States at Camp Hamilton Va, on the 22^d day
 of December, 1863, (or was mustered in service as a recruit, by St. W. H. Martin
U.C.M., at _____, on the _____ day of _____,
 186 , or was drafted and mustered into the service of the United States from the _____
 Enrollment District of the State of _____, at _____,
 on the _____ day of _____, 186), to serve in the Regiment, for
 the term of Three years: and having served **HONESTLY** and
FAITHFULLY with his Company in Virginia to the present date, is now
 entitled to a **DISCHARGE** by reason of Discharged from 15th 1864 in country

The said Private Fredrick Wood was last paid by Paymaster
Maj. Brewer to include the 29th day of February, 1864, and has
 pay due him from that time to the present date; he is entitled to pay and subsistence for
TRAVELING to place of enrollment, and whatever other allowances are authorized to volunteer
 soldiers, drafted men, or militia, so discharged. He has received from the United States **CLOTHING**
 amounting to \$ 56 $\frac{03}{100}$ dollars, since the 22^d day of December,
 1863, when his clothing account was last settled. He has received from the United States
 $\frac{ }{100}$ dollars advanced **BOUNTY**.

There is to be stopped from him, on account of the State of _____, or other
 authorities, for **CLOTHING**, &c., received on entering service, \$ 24 $\frac{13}{100}$ dollars; and
 for other stoppages, viz: one Curb Bridle, one Saddle
(value not known) _____ $\frac{ }{100}$ dollars.

He has been furnished with **TRANSPORTATION** in kind from the place of his discharge to
 _____; and he has been **SUBSISTED** for **TRAVELING** to his
 place of enrollment, up to the _____, 186 .

He is indebted to _____, **SUTLER**, _____ $\frac{ }{100}$ dollars.
 He is indebted to _____, **LAUNDRESS**, _____ $\frac{ }{100}$ dollars.

Given in Duplicate, at Norfolk Va, this 30th day
 of August, 1864.

Charles J. Schwarz
Captain

 Commanding Company.

Died June 5 1864, C.B. 710, P. 7.

Wood Henry W.

Co A, 1 U. S. Col'd Cav.

Private Private

CARD NUMBERS.

1	5-299551	26
2	5-299543	27
3	5-301706	28
4	5-301819	29
5	5-301924	30
6	5-302021	31
7	5-302117	32
8	5-302214	33
9	5-300697	34
10	5-302394	35
11	9085831	36
12	40725515	37
13		38
14		39
15		40
16		41
17		42
18		43
19		44
20		45
21		46
22		47
23		48
24		49
25		50

Book Mark:

See also

N | **1 Cav. U.S.C.T.**

Henry W Wood

Co. A, 1 Reg't U.S. Col'd Cav.

Appears on

Company Descriptive Book

of the organization named above.

DESCRIPTION.

Age *23* years; height *5* feet *1* inches.

Complexion *Black*

Eyes; *Black* hair *Black*

Where born *West Indies*

Occupation *Laborer*

ENLISTMENT.

When *Oct 5/64*

Where *Jamaica Ny.*

By whom *Capt Fowler*; term *1* y'rs.

Remarks: *Mustered out
by reason of expiration
of term of service Oct
27/65 at Brazoria
San Antonio Texas*

Houston

W. H. Law | U.S.C.T.

Henry M. Mason

Appears with rank of *Sgt* on

Muster and Descriptive Roll of a Detachment of U. S. Vols. forwarded

for the *1* Reg't U. S. Col'd *Law*, Roll dated

West Indies, Oct 5, 1864.

Where born *West Indies*

Age *23* y'rs; occupation *Laborer*

When enlisted *Oct 5*, 1864

Where enlisted *Jamaica*

For what period enlisted *1* years.

Eyes *Blue*; hair *Black*

Complexion *Black*; height *5* ft. *0* in.

When mustered in *Oct 5*, 1864.

Where mustered in *Jamaica*

Bounty paid \$ *33*^{*33*} *100*; due \$ *100*

Where credited *1 long list*

Company to which assigned *Jamaica*

Remarks:

Book mark:

[Signature]

(339)

Copyist.

28. | 1 Cav. | U.S.C.T.

Henry M. Wood

Appears with rank of Sgt. on

Muster and Descriptive Roll of a Detachment of U. S. Vols. forwarded

for the 1 Reg't U. S. Col'd Cavalry. Roll dated

Brooklyn, N.Y. Oct. 5, 1864.

Where born West Indies

Age 23 y'rs; occupation Labourer

When enlisted Oct. 5, 1864

Where enlisted Brooklyn, N.Y.

For what period enlisted 1 years.

Eyes Black; hair Black

Complexion Black; height 5 ft. 23 in.

When mustered in Oct. 5, 1864

Where mustered in Brooklyn, N.Y.

Bounty paid \$ 33 ³³/₁₀₀; due \$ 100

Where credited West. Long. Dist. N.Y.

Company to which assigned

Remarks: Paid Local

Bounty \$300

Book mark :

(339)

Leah Copyist.

W | **1 Cav.** | **U.S.C.T.**

Henry W. Wood

Priv., Co. A, 1 Reg't U. S. Col'd Cavalry.

Appears on

Company Muster Roll

for Nov. & Dec., 1864.

Present or absent Present

Stoppage, \$ 100 for

Due Gov't, \$ 100 for

Valuation of horse, \$ 100

Valuation of horse equipments, \$ 100

Remarks: Pay due from
date of enlistment.
Due U.S. for Ord.
Lost \$ 0.6.

Book mark: _____

(358)

Johnman

Copyist.

W | 1 Cav. | U.S.C.T.

Henry W. Wood
Priv., Co. A, 1 Reg't U. S. Col'd Cavalry.

Appears on

Company Muster Roll

for *Jan'y & Feby*, 1865.

Present or absent

Stoppage, \$ 100 for

Due Gov't, \$ 100 for

Valuation of horse, \$ 100

Valuation of horse equipments, \$ 100

Remarks: *Pay due from date of enlistment
Due U. S. for Ordnance lost \$10.61*

Book mark:

Johnson

(358)

Copyist.

W | 1 Cav. | U.S.C.T.

Henry M. Wood

Priv, Co. A, 1 Reg't U. S. Col'd Cavalry.

Appears on

Company Muster Roll

for March & April, 1865.

Present or absent Present

Stoppage, \$ 100 for

Due Gov't, \$ 100 for

Valuation of horse, \$ 100

Valuation of horse equipments, \$ 100

Remarks:

Book mark:

(358)

T. H. Man

Copyist.

W | **1 Cav.** | **U.S.C.T.**

Henry W. Wood
Private, Co. A, 1 Reg't U. S. Col'd Cavalry.

Appears on

Company Muster Roll

for May & June, 1865.

Present or absent Present

Stoppage, \$ 100 for

Due Gov't, \$ 100 for

Valuation of horse, \$ 100

Valuation of horse equipments, \$ 100

Remarks:

Book mark: -----

Johnson

(358)

Copyist.

W | **1 Cav.** | **U.S.C.T.**

Henry W Wood

Priv., Co. A, 1 Reg't U. S. Col'd Cavalry.

Appears on

Company Muster Roll

for July & August, 1865.

Present or absent Absent

Stoppage, \$ 100 for

Due Gov't, \$ 100 for

Valuation of horse, \$ 100

Valuation of horse equipments, \$ 100

Remarks: Sick in Genl
Hosptl at Brazos
Santiago, Texas since
Aug 15/65

Book mark :

Tobman

(358)

Copyist.

M | 1 Cav. | U.S.C.T.

Henry H. Hood
Prof., Co. A, 1 Reg't U. S. Col'd Cavalry.

Appears on

Company Muster Roll

for *Sept. and Oct.*, 1865.

Present or absent

Stoppage, \$ 100 for

Due Gov't, \$ 100 for

Valuation of horse, \$ 100

Valuation of horse equipments, \$ 100

Remarks: *Mustered out by reason of expiration of term of service Oct 22, 1865*

Book mark:

D.R. Webster

(358)

Copyist.

W. | 1 Cav. | U.S.C.T.

Fenny W. Wood

Priv, Co. *A*, 1 Reg't U. S. Colored Cav.

Appears on Returns as follows:

Nov 18 64 *Recruit*
found Co. Mar 7/64

Aug + Sept 18 65 *absent*
sick in Genl Hosp. at
Pragos Santiago Tex.

Oct 8 65: *Oct 21/65* *Pragos*
Santiago Tex. Mustered
out. by reason of expiration
of term of service.

Book mark:

W. W. Wood

W. H. Law | U.S.C.T.

Henry W. Wood
 Pvt, Co. A, 1 Reg't U. S. Col'd

Appears on an

Individual Muster-out Roll

of the organization named above. Roll dated

Pragos Santiago Tex Oct 22, 1865.

Muster-out to date Oct 22, 1865.

Last paid to Aug 31, 1865.

Clothing account: 0

Last settled _____, 186 _____; drawn since \$ _____ 100

Due soldier \$ 73 77 / 100; due U. S. \$ _____ 100

Am't for cloth'g in kind or money adv'd \$ _____ 100

Due U. S. for arms, equipments, &c., \$ _____ 100

Bounty paid \$ none 100 due \$ 100 100

Remarks: Mustered out
 by reason of expiration
 of term of service. Money
 value of clothing
 drawn by soldier

Book mark: _____

Saxton

JAN-5

5300697

* 1891 *

\$52.42.

due soldier for
clothing not
drawn \$23.77

H | 1 Cav - U.S.C.T.

Henry M. Hobbs

Int, Co. A, 1 Reg't U. S. Col'd Cav

Appears on **Co. Muster-out Roll**, dated

Brazos Santiago Tex, Feb 4, 1866.

Muster-out to date _____, 186 .

Last paid to _____, 186 .

Clothing account:

Last settled _____, 186 ; drawn since \$ _____ 100

Due soldier \$ _____ 100; due U. S. \$ _____ 100

Am't for cloth'g in kind or money adv'd \$ _____ 100

Due U. S. for arms, equipments, &c., \$ _____ 100

Bounty paid \$ _____ 100; due \$ _____ 100

Remarks: *joined as Recruit*
Mustered out at Bra-
zos Santiago Tex. October
22, 1865, expiration of
term of service.

Book mark: _____

D. G. Webster

(361)

Copyist.

Wood Henry H.

John, Co. _____, *1st* *usba* Reg't _____

13 Enclosures.

Bed Cards	Final Statements
Burial Records	Furloughs or L. of A.
Certs. of Dis. for Discharge	Med. Certificates
C. M. Charges	Med. Des. Lists
Descriptive Lists	Orders
Discharge Certificates	Pris. of War Record
Enlistment Papers	<i>2</i> Resignations

Other papers relating to—

Admission to Hosp'l	Furlough or L. of A.
Casualty Sheet	Med. Examination
Confinement	Misc. Information /
Contracts	Pay or Clothing
Death or Effects	Personal Reports
Desertion	Rank
Discharge from Hosp'l	Transfer to Hosp'l
Discharge from Service	Transfer to V. R. C.
Duty	Transportation

Kings County,
State of New York. } ^{ss}

I *Henry M. Wood* of *New York* do solemnly swear
that I am between the age of Eighteen and Forty-Five years.

as
Henry M. Wood
mail

Given at Brooklyn, N. Y.,
this *5th* day of *Oct* 1864. }

[Signature]

Capt. and Provo.-Mar. 3d Dist., N.Y.

NOTE 1.—This blank will be used for both enlistments and re-enlistments—enlistment of veterans, &c., &c., in the volunteer service. They will be made out in duplicate in all cases—one to accompany the recruiting return of the superintendent (not the recruiting officer) to the Adjutant General, and one to accompany the accounts of the officer who pays bounty, &c. The Regiment and Company in which the soldier last served should be given on the back.

NOTE 2.—An enlistment holds to service. A muster-in must, in all cases, precede payment of pay, bounty, pension, &c. A muster-in roll must, in all cases, be filed in the Adjutant General's Office as evidence of muster-in. The mustering officer, commissary, or assistant commissary of musters, as the case may be, will countersign both enlistments as having mustered the soldier into the service of the United States before either of them is given to the disbursing officer.

DECLARATION OF RECRUIT.

I, Henry W. Wood desiring to VOLUNTEER as a Soldier in the Army of the United States, for the term of THREE YEARS, Do Declare, That I am Twenty three years and _____ months of age; that I have never been discharged from the United States service on account of disability or by sentence of a court martial, or by order before the expiration of a term of enlistment; and I know of no impediment to my serving honestly and faithfully as a soldier for three years.

GIVEN at Brooklyn Ny the 5th day of Oct 1864

Witness: H. S. Davis

Henry W. Wood
man

No. 11611
Henry W. Wood
Volunteered at Brooklyn
Oct 5th, 1864
By John B. P. Stender
Regiment 5th Mass Heavy
Discharged _____, 18 ____
enlistment; last served in Company ()
Reg't of _____

Rec'd
21 80 7

CONSENT IN CASE OF MINOR.

I, _____, Do CERTIFY, That I am the _____ of _____; that the said _____ is _____ years of age; and I do hereby freely give my CONSENT to his volunteering as a SOLDIER in the ARMY OF THE UNITED STATES for the period of THREE YEARS.

GIVEN at _____ the _____ day of _____

Witness: _____

(A. G. O. No. 74 & 76.)

VOLUNTEER ENLISTMENT.

STATE OF

TOWN OF

New York



1st Dist N.Y.
Queens

I, *Henry W. Wood*, born in *Jamaica*,
in the State of *West Indies*, aged *Twenty three* years,
and by occupation a *Laborer*, Do HEREBY ACKNOWLEDGE to have
volunteered this *Fifth* day of *October*, 1864,
to serve as a **Soldier** in the **Army of the United States of America**, for
the period of *all* **THREE YEARS**, unless sooner discharged by proper authority:
Do also agree to accept such bounty, pay, rations, and clothing, as are, or may be,
established by law for volunteers. And I, *Henry W. Wood* do
solemnly swear, that I will bear true faith and allegiance to the **United States
of America**, and that I will serve them honestly and faithfully against all their
enemies or opposers whomsoever; and that I will observe and obey the orders of
the President of the United States, and the orders of the officers appointed over
me, according to the Rules and Articles of War.

Sworn and subscribed to, at

this

BEFORE

Brooklyn N.Y.
5th day of *Oct*, 1864, *Henry W. Wood*
mark

Capt. Wm. M. O'Day
I CERTIFY, ON HONOR, That I have carefully examined the above-named Volunteer, agreeably
to the General Regulations of the Army, and that, in my opinion, he is free from all bodily defects and
mental infirmity, which would in any way disqualify him from performing the duties of a soldier.

W. Allen
EXAMINING SURGEON.

I CERTIFY, ON HONOR, That I have minutely inspected the Volunteer *Henry W. Wood*
previously to his enlistment, and that he was entirely sober when enlisted; that, to the best of my
judgment and belief, he is of lawful age; and that, in accepting him as duly qualified to perform the
duties of an able-bodied soldier, I have strictly observed the Regulations which govern the recruiting
service. This soldier has *black* eyes, *black* hair, *black* complexion, is *five*
feet *2 3/4* inches high

Wm. M. O'Day
Regiment of *1st Dist N.Y.* Volunteers,
RECRUITING OFFICER.

Mustered into the service of the United States, for ~~three~~ *one* years or during the war, from date of enlistment, in Company
B Regiment of *1st Dist N.Y.* Volunteers, on the *5th* day of *Oct*, 1864, at *Brooklyn N.Y.*
Wm. M. O'Day
1st Dist N.Y.

NOTE 1.—This blank will be used for both enlistments and re-enlistments—enlistment of veterans, &c., &c., in the volunteer service. They will be made out in duplicate in all cases—one to accompany the recruiting return of the superintendent (not the recruiting officer) to the Adjutant General, and one to accompany the accounts of the officer who pays bounty, &c. The Regiment and Company in which the soldier last served should be given on the back.

NOTE 2.—An enlistment holds to service. A muster-in must, in all cases, precede payment of pay, bounty, pension, &c. A muster-in roll must, in all cases, be filed in the Adjutant General's Office as evidence of muster-in. The mustering officer, commissary, or assistant commissary of musters, as the case may be, will countersign both enlistments as having mustered the soldier into the service of the United States before either of them is given to the disbursing officer.

DECLARATION OF RECRUIT.

I, Henry W. Wood Desiring to VOLUNTEER as a Soldier in the Army of the United States, for the term of THREE YEARS, Do Declare, That I am Twenty three years and _____ months of age; that I have never been discharged from the United States service on account of disability or by sentence of a court martial, or by order before the expiration of a term of enlistment; and I know of no impediment to my serving honestly and faithfully as a soldier for three years.

GIVEN at Brooklyn, N.Y. the 5th day of Oct 1867

Witness: H. Davis Henry W. Wood mail

2220

No. 4614
Henry W. Wood
Volunteered at Brooklyn, N.Y.
Oct 5th, 1867
By John P. B. Starker
Regiment 1st N.Y.
_____ enlistment; last served in Company ()
1st Reg't of N.Y. Cavalry
Discharged _____, 1867

CONSENT IN CASE OF MINOR.

I, _____, Do CERTIFY, That I am the _____ of _____; that the said _____ is _____ years of age; and I do hereby freely give my CONSENT to his volunteering as a SOLDIER in the ARMY OF THE UNITED STATES for the period of THREE YEARS.

GIVEN at _____ the _____ day of _____

Witness: _____

VOLUNTEER ENLISTMENT.

STATE OF

New York

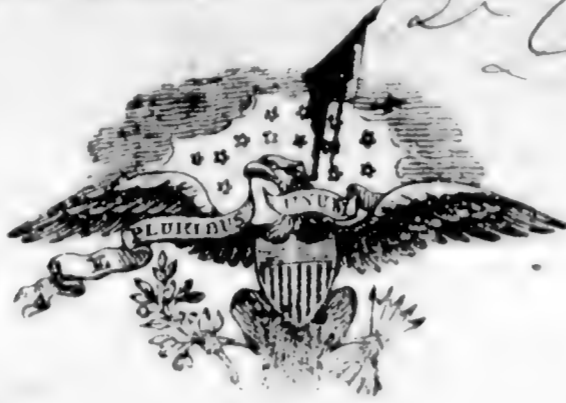

TOWN OF

Queens

I, *Henry W. Wood*, born in *Jamaica*, in the State of *West India*, aged *Twenty three* years, and by occupation a *Seaman*, Do HEREBY ACKNOWLEDGE to have volunteered this *Fifth* day of *October*, 186*1*, to serve as a **Soldier** in the **Army of the United States of America**, for the period of *three* ~~THREE~~ YEARS, unless sooner discharged by proper authority: Do also agree to accept such bounty, pay, rations, and clothing, as are, or may be, established by law for volunteers. And I, *Henry W. Wood*, do solemnly swear, that I will bear true faith and allegiance to the **United States of America**, and that I will serve them honestly and faithfully against all their enemies or opposers whomsoever; and that I will observe and obey the orders of the President of the United States, and the orders of the officers appointed over me, according to the Rules and Articles of War.

Sworn and subscribed to, at

this

Brooklyn NY
5th day of *Oct*, 186*1*

Henry W. Wood
his
man

BEFORE

Cap J. P. M. ...

I CERTIFY, ON HONOR, That I have carefully examined the above-named Volunteer, agreeably to the General Regulations of the Army, and that, in my opinion, he is free from all bodily defects and mental infirmity, which would in any way disqualify him from performing the duties of a soldier.

J. M. Allen
EXAMINING SURGEON.

I CERTIFY, ON HONOR, That I have minutely inspected the Volunteer *Henry W. Wood* previously to his enlistment, and that he was entirely sober when enlisted; that, to the best of my judgment and belief, he is of lawful age; and that, in accepting him as duly qualified to perform the duties of an able-bodied soldier, I have strictly observed the Regulations which govern the recruiting service. This soldier has *Black* eyes, *Black* hair, *Black* complexion, is *five* feet *2 3/4* inches high

John ...
REGIMENT OF *Volunteers*
RECRUITING OFFICER.

Mustered into the service of the United States, for ~~three~~ *over* years or during the war, from date of enlistment, in Company *B* of *1st* Regiment of *Volunteers*, on the *5th* day of *Oct* 186*1* at *Brooklyn NY*

as 1st Lieutenant

John ...
John ...
John ...

Woodes James

Co D, 1 U. S. Col'd Cav.

Private Private

CARD NUMBERS.

1	5305251	26
2	5305320	27
3	5305393	28
4	5305470	29
5	5305546	30
6	5305622	31
7	5305726	32
8	5305816	33
9	5305936	34
10	5306050	35
11	5306153	36
12	5306250	37
13	5306349	38
14	5306444	39
15	5306535	40
16	9086131	41
17		42
18		43
19		44
20		45
21		46
22		47
23		48
24		49
25		50

Book Mark: 2351-1850. 449388.

See also

W. | **1 Cav.** | **U.S.C.T.**

James Norris

....., Co. *D*....., 1 Reg't U.S. Col'd Cav.

Appears on

Company Descriptive Book

of the organization named above.

DESCRIPTION.

Age *20* years; height *5* feet *7* inches.

Complexion *Dk.*

Eyes; *Dk.* hair *Dk.*

Where born *Pine Bluff, Va.*

Occupation *Farmer.*

ENLISTMENT.

When *Dec 18/63.*

Where *Yorktown Va.*

By whom *Capt Wilson*; term *3* y'rs.

Remarks:

.....

.....

.....

.....

.....

.....

.....

Dickerson.

W | 1 Cav. | U.S.C.T.

James Wooder

Pvt., Co. D, 1 Reg't U. S. Col'd Cavalry.

Age 21 years.

Appears on

Company Muster-in Roll

of the organization named above. Roll dated

Camp near Mount Pleasant, Va., 1863.

Muster-in to date Dec 22, 1863.

Joined for duty and enrolled:

When Dec 18, 1863.

Where Yorkstown Va

Period 3 years.

Valuation of horse, \$.....100

Valuation of horse equipments, \$.....100

Remarks:

.....

.....

.....

Book mark:

E. B. Thompson

(356)

Copyist.

W | **1 Cav.** | **U.S.C.T.**

Juma Woods
Private, Co. D, 1 Reg't U. S. Col'd Cavalry.

Appears on

Company Muster Roll
for from Dec 22 to Dec 31, 1863.

Present or absent Present

Stoppage, \$ 100 for

Due Gov't, \$ 100 for

Valuation of horse, \$ 100

Valuation of horse equipments, \$ 100

Remarks:

Book mark:

(358)

E. B. Thompson
Copyist.

W | **1 Cav.** | **U.S.C.T.**

James Wooder
Priv, Co. D, 1 Reg't U. S. Col'd Cavalry.

Appears on

Company Muster Roll

for Jan & Feb., 1861 /

Present or absent Present

Stoppage, \$ 100 for

Due Gov't, \$ 100 for

Valuation of horse, \$ 100

Valuation of horse equipments, \$ 100

Remarks:

Book mark:

E. B. Thompson

(358)

Copyist.

W | 1 Cav. | U.S.C.T.

James Wooder

Pvt, Co. D, 1 Reg't U. S. Col'd Cavalry.

Appears on

Company Muster Roll

for *McN & Aple*, 186*4*!

Present or absent *Present*

Stoppage, \$ *100* for

Due Gov't, \$ *100* for

Valuation of horse, \$ *100*

Valuation of horse equipments, \$ *100*

Remarks:

[Empty lines for remarks]

Book mark:

E. B. Thompson

(358)

Copyist.

W | 1 Cav. | U.S.C.T.

James Woodas

Pr, Co. D, 1 Reg't U. S. Col'd Cavalry.

Appears on

Company Muster Roll

for *May & June*, 1864.

Present or absent *Absent*

Stoppage, \$ *100* for

Due Gov't, \$ *100* for

Valuation of horse, \$ *100*

Valuation of horse equipments, \$ *100*

Remarks: *Ab. on detach duty since
from Me. pr. sp. order dated
Wed. 2nd 1864. June 26. 64*

Book mark :

E. B. Thompson

(358)

Copyist.

W | 1 Cav. | U.S.C.T.

Janner Woodis
Pvt, Co. D, 1 Reg't U. S. Col'd Cavalry.

Appears on

Company Muster Roll

for July & Aug., 1861 /.

Present or absent Present

Stoppage, \$ 100 for

Due Gov't, \$ 100 for

Valuation of horse, \$ 100

Valuation of horse equipments, \$ 100

Remarks:

Book mark:

E. B. Thompson

(358)

Copyist.

H

1 Cav. | U.S.C.T.

James Hood

Co, Co. D, 1 Reg't U. S. Col'd Cavalry.

Appears on

Company Muster Roll

for *Sept 1*, 186*4*.

Present or absent *Present*

Stoppage, \$ *100* for

Due Gov't, \$ *100* for

Valuation of horse, \$ *100*

Valuation of horse equipments, \$ *100*

Remarks:

Book mark:

James

(358)

Copyist.

7 | **1 Cav.** | **U.S.C.T.**

James Harris

701, Co. D, 1 Reg't U. S. Col'd Cavalry.

Appears on

Company Muster Roll

for *Nov Dec*, 186*4*.

Present or absent *Present*

Stoppage, \$ *100* for

Due Gov't, \$ *100* for

Valuation of horse, \$ *100*

Valuation of horse equipments, \$ *100*

Remarks:

Book mark: -----

James Harris

(358) Copyist.

74 | **1 Cav.** | **U.S.C.T.**

James Harris
Pvt, Co. D, 1 Reg't U. S. Col'd Cavalry.

Appears on

Company Muster Roll

for Camp 1st Regt, 186 5.

Present or absent Present

Stoppage, \$ 100 for

Due Gov't, \$ 100 for

Valuation of horse, \$ 100

Valuation of horse equipments, \$ 100

Remarks:

Book mark:

(358)

Adams

Copyist.

H

1 Cav. U.S.C.T.

James Hoodie

Co. D, Co. D, 1 Reg't U. S. Col'd Cavalry.

Appears on

Company Muster Roll

for *May 1864*, 1864.

Present or absent *Present*

Stoppage, \$ *100* for

Due Gov't, \$ *100* for

Valuation of horse, \$ *100*

Valuation of horse equipments, \$ *100*

Remarks:

Book mark:

Alman

(358)

Copyist.

77

1 Cav. U.S.C.T.

James Hoodis

Co. D, 1 Reg't U. S. Col'd Cavalry.

Appears on

Company Muster Roll

for May 1864

Present or absent Present

Stoppage, \$ 100 for

Due Gov't, \$ 100 for

Valuation of horse, \$ 100

Valuation of horse equipments, \$ 100

Remarks:

Book mark:

W. H. Jones

77 | 1 Cav. | U.S.C.T.

James Hoodie
Cpt, Co. D, 1 Reg't U. S. Col'd Cavalry.

Appears on

Company Muster Roll

for July 1865, 1865.

Present or absent Present

Stoppage, \$ 100 for

Due Gov't, \$ 100 for

Valuation of horse, \$ 100

Valuation of horse equipments, \$ 100

Remarks:

Book mark:

(358)

W. H. Jones

Copyist.

2474 1 Cav. U.S.C.T.

x Woodis
James Woodis

Priv., Co. D, 1 Reg't U. S. Col'd Cavalry.

Appears on

Company Muster Roll

for *Sept. & Oct.*, 186*5*.

Present or absent *Present*

Stoppage, \$ *100* for

Due Gov't, \$ *100* for

Valuation of horse, \$ *100*

Valuation of horse equipments, \$ *100*

Remarks:

Corrected by J. McFall &

Book mark:

H. E. Wilson

(358)

Copyist.

H | **1 Cav.** | **U.S.C.T.**

James Hood

Priv., Co. D, 1 Reg't U. S. Col'd Cavalry.

Appears on

Company Muster Roll

for *Nov. & Dec.*, 186*5*.

Present or absent *Absent*

Stoppage, \$ *100* for

Due Gov't, \$ *100* for

Valuation of horse, \$ *100*

Valuation of horse equipments, \$ *100*

Remarks: *On detached duty per spec. ord. No. 62. Sept. 13, 1865 in R.M.D.*

Book mark:

R. E. Wilson

(358)

Copyist.

H | **1 Cav.** | **U.S.C.T.**

James Morris
 Priv., Co. *D*, 1 Reg't U. S. Col'd Cavalry.

Appears on **Co. Muster-out Roll**, dated
Brazos Santiago Tex. Feb. 14, 1866.
 Muster-out to date *Feb. 14*, 1866.
 Last paid to *Aug 31*, 1865.

Clothing account:

Last settled _____, 186 ; drawn since \$ _____ 100
 Due soldier \$ _____ 100; due U. S. \$ _____ 5 ²¹/₁₀₀
 Am't for cloth'g in kind or money adv'd \$ _____ 100

Due U. S. for arms, equipments, &c., \$ _____ 100
 Bounty paid \$ _____ 100; due \$ _____ 100

Remarks: *Joined at orig org.*

Book mark: *2351-1880* *449388*

(361)

R. E. Wilson
 Copyist.

Woodhouse Elias

Col, 1 U. S. Col'd Cav.

Private

Private

CARD NUMBERS.

1	5299382	26
2	5306756	27
3	5306830	28
4	5306905	29
5	5306976	30
6	5307068	31
7	5307166	32
8	5307268	33
9	5307375	34
10	5307474	35
11	5307571	36
12	5307666	37
13	5307753	38
14	5307846	39
15	9086241	40
16	32537380	41
17	32538389	42
18	32539411	43
19	32540528	44
20	33224792	45
21	33240398	46
22	33237726	47
23	33240882	48
24	40725516	49
25		50

Book Mark: PV39.P91.47

See also _____

D. 196972800mm.
S 2751001 (and W)

P.O. M. M. Co. 162955 - 9-13-17-~~55~~

U.S. Vet Bureau 9/12/51 Jewett

W. J. Perry Jr

N. | 1 Cav. | U.S.C.T.

Elias Woodhouse

....., Co. *E.*, 1 Reg't U.S. Col'd Cav.

Appears on

Company Descriptive Book

of the organization named above.

DESCRIPTION.

Age *18* years; height *5* feet *10* inches.

Complexion *Blk.*

Eyes; *Blk* hair *Blk.*

Where born *Allomac Co. Va.*

Occupation *Farmer.*

ENLISTMENT.

When *Dec 10-63.*

Where *Norfolk Va.*

By whom *L. Page*; term *3* y'rs.

Remarks:

Dickerson

A

1 Cav. | U.S.C.T.

Elias Goodhouse

Pri, Co. E, 1 Reg't U. S. Col'd Cavalry.

Appears on

Company Muster Roll

for *Jan & Feb*, 1864.

Joined for duty and enrolled:

When *Dec 10*, 1863.*

Where *Norfolk Va* *

Period *3* years.*

Present or absent *Present*

Stoppage, \$ *100* for

Due Gov't, \$ *100* for

Valuation of horse, \$ *100*

Valuation of horse equipments, \$ *100*

Remarks: *Not Paid since enrollment*

* See enrollment on card from muster-in roll.

Book mark:

E. W. [Signature]

A | 1 Cav. | U.S.C.T.

Elias Woodhouse

Appears with rank of *Priv* on

Muster and Descriptive Roll of a Detachment of U. S. Vols. forwarded

for the 1 Reg't U. S. Col'd Cavalry. Roll dated

Ft. Monroe Va. Feby 22, 1864.

Where born *Norfolk Va.*

Age *16* y'rs; occupation *Farmer*

When enlisted *Dec 10*, 186 .

Where enlisted *Norfolk Va*

For what period enlisted *3* years.

Eyes *Blk*; hair *Blk*

Complexion *Blk*; height *5* ft. *0* in.

When mustered in *Feby 22*, 186 *4*

Where mustered in *Ft. Monroe*

Bounty paid \$ *10* ¹⁰⁰; due \$ ¹⁰⁰

Where credited

Company to which assigned

Remarks :

Book mark :

A Harris

(339)

Copyist.

H

1 Cav.

U.S.C.T.

Elias Goodhouse

Ft, Co. E, 1 Reg't U. S. Col'd Cavalry.

Appears on

Company Muster Roll

for *Nov & Apr*, 1864.

Joined for duty and enrolled :

When *Dec 10*, 1863.*

Where *Southern Va**

Period *7* years.*

Present or absent *Present*

Stoppage, \$ *100* for

Due Gov't, \$ *100* for

Valuation of horse, \$ *100*

Valuation of horse equipments, \$ *100*

Remarks:

* See enrollment on card from muster-in roll.

Book mark:

D. W. [Signature]

4 | **1 Cav.** | **U.S.C.T.**

Elias Woodhouse

Pi, Co. E, 1 Reg't U. S. Col'd Cavalry.

Appears on

Company Muster Roll

for *May June*, 1864.

Joined for duty and enrolled:

When *Dec 10*, 1863.*

Where *Norfolk Va.* *

Period *3* years.*

Present or absent *Present*

Stoppage, \$ *100* for

Due Gov't, \$ *100* for

Valuation of horse, \$ *100*

Valuation of horse equipments, \$ *100*

Remarks:

.....
.....
.....
.....

* ~~See~~ See enrollment on card from muster-in roll.

Book mark:

[Signature]

81 | 1 Cav. | U.S.C.T.

Chas Goodhouse

Fu, Co. E, 1 Reg't U. S. Col'd Cavalry.

Appears on

Company Muster Roll

for *July & Aug*, 186*7*.

Joined for duty and enrolled :

When *Dec 10*, 186*3*.*

Where *Norfolk va* *

Period *3* years.*

Present or absent *Present*

Stoppage, \$ *100* for

Due Gov't, \$ *100* for

Valuation of horse, \$ *100*

Valuation of horse equipments, \$ *100*

Remarks :

* ~~See~~ See enrollment on card from muster-in roll.

Book mark :

E. M. Merve

(358c)

Copyist.

W | 1 Cav. | U.S.C.T.

Elias Woodhouse

Private, Co. E, 1 Reg't U. S. Col'd Cavalry.

Appears on

Company Muster Roll

for Sept. & Oct., 1864.

Joined for duty and enrolled:

When Dec. 10, 1863.*

Where Norfolk Va *

Period 3 years.*

Present or absent Absent.

Stoppage, \$ 100 for

Due Gov't, \$ 1 ⁴⁴/₁₀₀ for Ordinance.

Valuation of horse, \$ 100

Valuation of horse equipments, \$ 100

Remarks: Sick in hospital at Fort Monroe, Va

* See enrollment on card from muster-in roll.

Book mark:

(358c)

Wagner

Copyist.

W | 1 Cavalry

E. Woodard

Cpt, Co. E, 1 Reg't U.S.C.

Appears on

Hospital Muster Roll

of **U. S. A. General Hospital,**

at **Fort Monroe, Va.,**

for Sept & Oct, 1864

Attached to hospital :

When _____, 1864 .

How employed _____

Last paid by Maj. _____

to _____, 1864 .

Bounty paid \$ 100 ; due \$ 100

Present or absent Present

Remarks : No Des. list

wards 21 & 22: Hampton Station

Book mark : _____

(343)

A. W. King
Copyist.

W | **1 Cav.** | **U.S.C.T.**

Wm. Woodhouse

Capt., Co. E, 1 Reg't U. S. Col'd Cavalry.

Appears on

Company Muster Roll

for *Nov 7 Dec.*, 1864.

Joined for duty and enrolled:

When *Dec. 10*, 1863.*

Where *Fordham Va* *

Period *3* years.*

Present or absent *Absent*

Stoppage, \$ *100* for

Due Gov't, \$ *1* ^{*44*}/_{*100*} for *Ordinance*

Valuation of horse, \$ *100*

Valuation of horse equipments, \$ *100*

Remarks: *Spoken to at Ft. Monroe, Va. since Sep. 1864.*

* See enrollment on card from muster-in roll.

Book mark:

(358c)

W. Woodhouse

Copyist.

M 1 / cav. U.S.C.T.

Elias Woodus

Pvt, Co. *E*, *1* Reg't *U.S.C.T.*

Appears on

Hospital Muster Roll

of **Balfour U. S. A. General Hospital,**

at **Portsmouth, Va.,**

for *Nov. & Dec*, 186 *4*.

Attached to hospital :

When, 186 .

How employed

Last paid by Maj.

to, 186 .

Bounty paid \$ 100; due \$ 100

Present or absent *Present*

Remarks :

Book mark:

(848)

Puntenney

Copyist.

W | 1 Cav. | U.S.C.T.

Elias Woodhouse

Co. E, 1 Reg't U. S. Col'd Cavalry.

Appears on

Company Muster Roll

for Jan. 7 Feb., 1865.

Joined for duty and enrolled:

When Dec. 10, 1863.*

Where Norfolk, Va. *

Period 3 years.*

Present or absent Absent.

Stoppage, \$ 100 for

Due Gov't, \$ 1⁴⁴ 100 for Inducement

Valuation of horse, \$ 100

Valuation of horse equipments, \$ 100

Remarks:

Absent in Hospital at Ft. Monroe, Va. since Sept. 1864.

* See enrollment on card from muster-in roll.

Book mark:

Maguire

(358c)

Copyist.

H. | *1 Cav. U.S.C.*

Alias Hoodus

Priv. Co. E, *1* Reg't *U.S.C.*

Appears on

Hospital Muster Roll

of **Balfour U. S. A. General Hospital,**

at **Portsmouth, Va.,**

for *January and Feb'y*, 186*5*.

Attached to hospital:

When, 186 .

How employed

Last paid by Maj.

to, 186 .

Bounty paid \$ *100*; due \$ *100*

Present or absent *Present*

Remarks :

Book mark :

Park

1 Cav. U.S.C.T.

Elias Woodhouse

Private, Co. E, 1 Reg't U. S. Col'd Cavalry.

Appears on

Company Muster Roll

for *May 7* *Apr.*, 186*5*.

Joined for duty and enrolled :

When *see 10*, 186*3*.*

Where *Norfolk* *

Period *3* years.*

Present or absent *Absent.*

Stoppage, \$ *100* for

Due Gov't, \$ *100* for

Valuation of horse, \$ *100*

Valuation of horse equipments, \$ *100*

Remarks: *Sick at Ft. Monroe*
Absepl. since Sept. '64

* See enrollment on card from muster-in roll.

Book mark :

(358c)

W. J. ...

Copyist.

W 1 1 cav. U.S.C.

Elias Woodus

Priv. Co. E, 1 Reg't U.S.C.

Appears on

Hospital Muster Roll

of **Balfour U. S. A. General Hospital,**

at **Portsmouth, Va.,**

for *Mar + Apr, 1865*

Attached to hospital :

When, 186 .

How employed

Last paid by Maj.

to, 186 .

Bounty paid \$ 100; due \$ 100

Present or absent *Present*

Remarks :

.....
.....
.....
.....
.....
.....

Book mark :

Reynolds
Copyist.

(848)

M. | **1 Cav.** | **U.S.C.T.**

Elias Woodhouse
Pat., Co. E, 1 Reg't U. S. Col'd Cavalry.

Appears on

Company Muster Roll

for *May & June*, 186*6*.

Joined for duty and enrolled :

When *Dec. 10*, 186*3*.*

Where *Norfolk* *

Period *3* years.*

Present or absent *Absent.*

Stoppage, \$ *100* for

Due Gov't, \$ *100* for

Valuation of horse, \$ *100*

Valuation of horse equipments, \$ *100*

Remarks: *Sick in Hospital,*
Va., at Portsmouth since
Sep., 1864.

* See enrollment on card from muster-in roll.

Book mark :

ASL
 Copyist.

M | *1 Cav. U.S.C.*

Elias Hodges

Port., Co. E., 1 Regt U.S.C.

Appears on

Hospital Muster Roll

of **Balfour U. S. A. General Hospital,**

at **Portsmouth, Va.,**

for *May & June*, 1865.

Attached to hospital:

When _____, 186 .

How employed _____

Last paid by Maj. _____

to _____, 186 .

Bounty paid \$ 100; due \$ 100

Present or absent _____

Remarks: *Transferred to
2d L.H. Art. Monroe, Va
June 27/65*

Book mark: _____

(848)

Staylor
Copyist.

W 1 1 Cav. U.S.C.T.

Eli Woodus

Pvt., Co. E, 1 Reg't U.S.C. Cav.

Appears on

Hospital Muster Roll

of U. S. A. General Hospital,

at Fort Monroe, Va.,

for May June, 1865.

Attached to hospital :

When, 186 .

How employed

Last paid by Maj.

to, 186 .

Bounty paid \$ 100 ; due \$ 100

Present or absent present

Remarks : No Descriptive List.

Dec. 2 Div.

Book mark :

Woodus

27. | 1 Cav. | U.S.C.T.

Elias Woodhouse

Priv., Co. E, 1 Reg't U. S. Col'd Cavalry.

Appears on

Company Muster Roll

for *July & Aug*, 1865.

Joined for duty and enrolled :

When *Dec. 10*, 1863.*

Where *Norfolk, Va* *

Period *3* years.*

Present or absent *Absent*.

Stoppage, \$ *100* for

Due Gov't, \$ *100* for

Valuation of horse, \$ *100*

Valuation of horse equipments, \$ *100*

Remarks: *Absent sick in hospital at Ft. Monroe, Va. since Sep. 1864.*

* See enrollment on card from muster-in roll.

Book mark :

Asst.
Copyist.

A 1 / cav. 17th S.C.T.

Elias Woodson

Priv., Co. E, 1 Reg. 17th S.C.T.

Appears on

Hospital Muster Roll

of U. S. A. General Hospital,

at Fort Monroe, Va.,

for *July & Aug*, 1865.

Attached to hospital :

When _____, 186 .

How employed _____

Last paid by Maj. _____

to _____, 186 .

Bounty paid \$ *100* ; due \$ *100*

Present or absent *Present*

Remarks : _____

Book mark : _____

(343)

[Signature]
Copyist.

W | **1 Cav.** | **U.S.C.T.**

Elias Woodhouse

Priv, Co. E, 1 Reg't U. S. Col'd Cavalry.

Appears on

Company Muster Roll

for *Sept & Oct*, 186*5*.

Joined for duty and enrolled :

When *Dec 6*, 186*3*.*

Where *Norfolk* *

Period *3* years.*

Present or absent *Absent*

Stoppage, \$ *100* for

Due Gov't, \$ *100* for

Valuation of horse, \$ *100*

Valuation of horse equipments, \$ *100*

Remarks: *Sick at Ft Mon-*
roe since Sept 1864.

* See enrollment on card from muster-in roll.

Book mark :

aw Allen

(358c)

Copyist.

7-1 Cav-105, 105

Elias Woodas

Pr', Co. E, / Regt U.S.C. Cav.

Appears on

Hospital Muster Roll

of U. S. A. General Hospital,

at Fort Monroe, Va.,

for Sept to Oct, 1865

Attached to hospital :

When, 186 .

How employed

Last paid by Maj.

to, 186 .

Bounty paid \$ 100; due \$ 100

Present or absent Present

Remarks :

Book mark :

J. Wood

71 | 1 Cav. | U.S.C.T.

Elias Woodhouse

Priv, Co. E, 1 Reg't U. S. Col'd Cavalry.

Appears on

Company Muster Roll

for Nov & Dec, 1865.

Joined for duty and enrolled:

When Dec 10, 1863.*

Where Norfolk *

Period 3 years.*

Present or absent Absent

Stoppage, \$ 100 for

Due Gov't, \$ 100 for

Valuation of horse, \$ 100

Valuation of horse equipments, \$ 100

Remarks: Sick at Ft Monroe, Va.

* See enrollment on card from muster-in roll.

Book mark:

A. W. Allen

W | 1 Cav. | U.S.C.T.

Elias Woodhouse

Pat, Co. *E*, 1 Reg't U. S. Colored Cav.

Appears on Returns as follows:

Feby 1864 *Feby 22/64*
Ft Monroe Va *Enlisted in*
the Co.

Sept 1864 to April 1865. absent
sick in Hosp. Ft Monroe Va
since Sept 1864

May to July 1865. absent sick
in Genl Hosp. Va

Aug 1865. absent D. S. Gen
Hdqrs

Sept to Dec 1865. absent sick
in Hosp. at Ft Monroe Va

Book mark :

Pat Patton

W | Car | U. S. C. T.

Uias Woodhouse

Pio, Co. E, 1 Reg't U. S. Col'd Cavalry

Appears on **Co. Muster-out Roll**, dated

Brazo Santiago Texas, Feb 4, 1866.

Muster-out to date *Feb 4, 1866.*

Last paid to *Feb 29, 1864.*

Clothing account:

Last settled _____, 186 ; drawn since \$ _____ 100

Due soldier \$ *2* ^{*20*}/₁₀₀; due U. S. \$ _____ 100

Am't for cloth'g in kind or money adv'd \$ _____ 100

Due U. S. for arms, equipments, &c., \$ _____ 100

Bounty paid \$ *none* 100 due \$ *none* 100

Remarks: *Joined at org. org.*

Has received pay for months

Jan Feb May June 1865

\$64 while in Hospital.

Book mark: *PY39, P91, 77.*

U. S. Allen

1917
Woodhouse George

Co L, 1 U. S. Col'd Cav.

Private Corporal

CARD NUMBERS.

1	5309368	26
2	5309437	27
3	5309524	28
4	5309610	29
5	5309699	30
6	5300490	31
7	5309782	32
8	5309869	33
9	5309960	34
10	5310068	35
11	5310175	36
12	5310278	37
13	5310294	38
14	5310396	39
15	5310485	40
16	5310571	41
17	9086478	42
18	34354890	43
19		44
20		45
21		46
22		47
23		48
24		49
25		50

Book Mark:

See also

N. | **1 Cav. | U.S.C.T.**

George Woodhouse.

....., Co. *G*, 1 Reg't U.S. Col'd Cav.

Appears on

Company Descriptive Book

of the organization named above.

DESCRIPTION.

Age *22* years; height *5* feet *7* inches.

Complexion *Dark*

Eyes; *Black* hair *Black.*

Where born *Princess Anne, Va.*

Occupation *Farmer.*

ENLISTMENT.

When *Nov 30 - 1863.*

Where *Norfolk Va.*

By whom *Capt Brown*; term *3* y'rs.

Remarks:

.....

.....

.....

.....

.....

.....

.....

.....

.....

Dickerson.

M

1 Cav. U.S.C.T.

George Woodhouse

Pri, Co. G, 1 Reg't U. S. Col'd Cavalry.

Age 22 years.

Appears on

Company Muster-in Roll

of the organization named above. Roll dated

Camp Hamilton Va Dec 22, 1863.

Muster-in to date

Dec 22, 1863.

Joined for duty and enrolled:

When Nov 30, 1863.

Where Norfolk Va

Period 3 years.

Valuation of horse, \$ 100

Valuation of horse equipments, \$ 100

Remarks:

Book mark:

Dannelly

(356)

Copyist.

W | 1 Cav. | U.S.C.T.

George Woodhouse

Pri, Co. G, 1 Reg't U.S. Col'd Cavalry.

Appears on

Company Muster Roll

for Dec 22 to 31, 1863.

Present or absent Present

Stoppage, \$ 100 for

Due Gov't, \$ 100 for

Valuation of horse, \$ 100

Valuation of horse equipments, \$ 100

Remarks:

Book mark:

Donnelly

(358)

Copyist.

W | 1 Cav. | U.S.C.T.

George Woodhouse
Pri

Co. G, 1 Reg't U. S. Col'd Cavalry.

Appears on

Company Muster Roll

for

Jan & Feb, 186 *4*

Present or absent

Present

Stoppage, \$ 100 for

Due Gov't, \$ 100 for

Valuation of horse, \$ 100

Valuation of horse equipments, \$ 100

Remarks:

Book mark:

Donnelly

(358)

Copyist.

W | 1 Cav. | U.S.C.T.

George Woodhouse

Pvt, Co. G, 1 Reg't U. S. Col'd Cavalry.

Appears on

Company Muster Roll

for *Mar & Apr*, 186 *4*.

Present or absent *Present*

Stoppage, \$ *100* for

Due Gov't, \$ *100* for

Valuation of horse, \$ *100*

Valuation of horse equipments, \$ *100*

Remarks:

Book mark:

Donnelly

(358)

Copyist.

W | 1 Cav. | U.S.C.T.

George Woodhouse

Pvt., Co. G, 1 Reg't U. S. Col'd Cavalry.

Appears on

Company Muster Roll

for May - June, 1864

Present or absent Absent

Stoppage, \$ 100 for

Due Gov't, \$ 100 for

Valuation of horse, \$ 100

Valuation of horse equipments, \$ 100

Remarks: On det service per special order dated Hd Qrs 1st USCC in the field June 26. 64

Book mark:

Samuelly

(358)

Copyist.

W V Cav. U.S.C.T.

George Woodhouse
Capt 1 Regt U.S.C.T.

Appears on

Muster Roll

of Enlisted men, ambulance
Corps, 1 Division, 18th
U.C.

for May & June, 1864.

Station In the Field

Clothing account:

Last settled _____, 186; drawn since \$ _____ 100

Present or absent Present

Remarks:

Book mark: _____

(520)

Ragan Copyist.

W 1 Cav | **U.S.C.T.**

George Woodhouse
Pvt, Co. G, 1 Reg't U. S. Col'd Cavalry
Appears on a

Detachment Muster Roll

of the organization named above

for Dated June 30, 1864.

Station In the Field

Present or absent Present

Stoppage, \$ 100 for

Due Gov't, \$ 100 for

Valuation of horse, \$ 100

Valuation of horse equipments, \$ 100

Remarks :

Book mark :

(344) Hammer Copyist.

W | 1 Cav. | U.S.C.T.

George Woodhouse

Pri, Co. G, 1 Reg't U. S. Col'd Cavalry.

Appears on

Company Muster Roll

for July & Aug, 1864

Present or absent Present

Stoppage, \$ 100 for

Due Gov't, \$ 100 for

Valuation of horse, \$ 100

Valuation of horse equipments, \$ 100

Remarks:

Book mark:

Donnelly

(358)

Copyist.

W

1 Cav. U.S.C.T.

George Woodhouse

Priv, Co. G, 1 Reg't U. S. Col'd Cavalry.

Appears on

Company Muster Roll

for *Sept & Oct*, 186 *7*

Present or absent *Present*

Stoppage, \$ *100* for

Due Gov't, \$ *100* for

Valuation of horse, \$ *100*

Valuation of horse equipments, \$ *100*

Remarks:

Book mark:

W. H. Thompson

(358)

Copyist.

N | 1 Cav. | U.S.C.T.

George Woodhouse

Pr....., Co. G, 1 Reg't U. S. Col'd Cavalry.

Appears on

Company Muster Roll

for *Nov & Dec*....., 186*4*

Present or absent *Present*.....

Stoppage, \$.....*100* for.....

Due Gov't, \$.....*100* for.....

Valuation of horse, \$.....*100*

Valuation of horse equipments, \$.....*100*

Remarks:.....

Book mark:.....

W.A. Thompson
Copyist.

(358)

W

1 Cav. U.S.C.T.

George Woodhouse

Priv, Co. G, 1 Reg't U. S. Col'd Cavalry.

Appears on

Company Muster Roll

for *Jany & Geby*, 1865.

Present or absent *Present*

Stoppage, \$ 100 for

Due Gov't, \$ 100 for

Valuation of horse, \$ 100

Valuation of horse equipments, \$ 100

Remarks:

Book mark:

W H Thompson

(358)

Copyist.

W | 1 Cav. | U.S.C.T.

George Woodhouse

Pvt, Co. G, 1 Reg't U. S. Col'd Cavalry.

Appears on

Company Muster Roll

for *March & April*, 1865.

Present or absent *Present*

Stoppage, \$ 100 for

Due Gov't, \$ 100 for

Valuation of horse, \$ 100

Valuation of horse equipments, \$ 100

Remarks:

Book mark:

(358)

W. A. Thompson
Copyist.

W | 1 Cav. | U.S.C.T.

George Woodhouse

Priv, Co. G, 1 Reg't U. S. Col'd Cavalry.

Appears on

Company Muster Roll

for *May & June*, 186 *5*.

Present or absent *Present*

Stoppage, \$ *100* for

Due Gov't, \$ *100* for

Valuation of horse, \$ *100*

Valuation of horse equipments, \$ *100*

Remarks:

Book mark:

W. H. Thompson
Copyist.

(358)

W | 1 Cav. | U.S.C.T.

George Woodhouse

Corpl, Co. G, 1 Reg't U. S. Col'd Cavalry.

Appears on

Company Muster Roll

for *July & Aug.*, 1865.

Present or absent *Present*

Stoppage, \$ *100* for

Due Gov't, \$ *35*/₁₀₀ for *Ordinance*

Valuation of horse, \$ *100*

Valuation of horse equipments, \$ *100*

Remarks: *Appointed Corpl, from
Priv Aug 23/65*

Book mark :

W.H. Thompson

(358)

Copyist.

A | 1 Cav. | U.S.C.T.

George Woodhouse
Corpl, Co. G, 1 Reg't U. S. Col'd Cavalry.

Appears on

Company Muster Roll

for Sept 9th 1863, 1863.

Present or absent present

Stoppage, \$ 100 for

Due Gov't, \$ 100 for

Valuation of horse, \$ 100

Valuation of horse equipments, \$ 100

Remarks:

Book mark:

(358)

May

Copyist.

A | 1 Cav. | U.S.C.T.

George Woodhouse
Corpl, Co. G, 1 Reg't U. S. Col'd Cavalry.

Appears on

Company Muster Roll

for *Month*, 186 *5*

Present or absent *present*

Stoppage, \$ *100* for

Due Gov't, \$ *100* for

Valuation of horse, \$ *100*

Valuation of horse equipments, \$ *100*

Remarks:

Book mark:

Moy

(358)

Copyist.

A | 1 Cav. | U.S.C.T.

George Woodhouse
Corpl. G, Co., 1 Reg't U. S. Col'd Cavalry.

Appears on Co. Muster-out Roll, dated
Brazos Santiago Tx, Feb 4, 1866.

Muster-out to date *Feb 4, 1866.*

Last paid to *Aug 31, 1865.*

Clothing account:

Last settled, 186 ; drawn since \$ 100

Due soldier \$ 100; due U. S. \$ *33*/₁₀₀^{*42*}

Am't for cloth'g in kind or money adv'd \$ 100

Due U. S. for arms, equipments, &c., \$ 100

Bounty paid \$ 100; due \$ 100

Remarks: *Joined at Orgl Org.*
Was Private until Aug 23/65.

Book mark :

(361)

Moy

Copyist.

1515
Woodhouse Henry

Co G, 1 U. S. Col'd Cav.

Personal papers herein.

Reguler

Private

CARD NUMBERS.

1	5309318	26
2	5309387	27
3	5309525	28
4	5309611	29
5	5309698	30
6	5300362	31
7	5309783	32
8	5309870	33
9	5309961	34
10	5310069	35
11	5310176	36
12	5310279	37
13	5310371	38
14	5310466	39
15	5310552	40
16	5310638	41
17	9086477	42
18	32528531	43
19	40725517	44
20		45
21		46
22		47
23		48
24		49
25		50

Book Mark:

See also

M. | 1 Cav. | U.S.C.T.

Henry Woodhouse

....., Co. *G.*....., 1 Reg't U.S. Col'd Cav.

Appears on

Company Descriptive Book

of the organization named above.

DESCRIPTION.

Age *20* years; height *5* feet *4* inches.

Complexion *Dark.*

Eyes; *Black* hair *Black.*

Where born *Princess Anne Va.*

Occupation *Farmer.*

ENLISTMENT.

When *Dec 1-1863.*

Where *Norfolk Va.*

By whom *Capt Brown*; term *3.* y'rs.

Remarks:

.....

Dickerson.

W | 1 Cav. | U.S.C.T.

Henry Woodhouse

Baylor, Co. G, 1 Reg't U. S. Col'd Cavalry.

Age 20 years.

Appears on

Company Muster-in Roll

of the organization named above. Roll dated

Camp Hamilton Va, Dec 22, 1863.

Muster-in to date Dec 22, 1863.

Joined for duty and enrolled:

When Dec 1, 1863

Where Norfolk Va

Period 3 years.

Valuation of horse, \$ 100

Valuation of horse equipments, \$ 100

Remarks:

Book mark:

Donnelly

(356)

Copyist.

W | 1 Cav. | U.S.C.T.

Henry Woodhouse
Baylor, Co. G, 1 Reg't U. S. Col'd Cavalry.

Appears on

Company Muster Roll

for Dec 22 to 31, 186 3

Present or absent Present

Stoppage, \$ 100 for

Due Gov't, \$ 100 for

Valuation of horse, \$ 100

Valuation of horse equipments, \$ 100

Remarks:

Book mark:

Donnelly

(358)

Copyist.

W | 1 Cav. | U.S.C.T.

Henry Woodhouse

Pi, Co. G, 1 Reg't U. S. Col'd Cavalry.

Appears on

Company Muster Roll

for Jan & Feb, 1864

Present or absent Present

Stoppage, \$ 100 for

Due Gov't, \$ 100 for

Valuation of horse, \$ 100

Valuation of horse equipments, \$ 100

Remarks:

Book mark:

Donnelly

(358)

Copyist.

W | 1 Cav. | U.S.C.T.

Henry Woodhouse

Pri, Co. G, 1 Reg't U. S. Col'd Cavalry.

Appears on

Company Muster Roll

for Mar 1864, 1864

Present or absent Absent

Stoppage, \$ 100 for

Due Gov't, \$ 100 for

Valuation of horse, \$ 100

Valuation of horse equipments, \$ 100

Remarks: Sick in General
Hospital

Book mark:

Samuelly

(358)

Copyist.

W | 1 Cav. | U.S.C.T.

Henry Woodhouse

Pri, Co. G, 1 Reg't U. S. Col'd Cavalry.

Appears on

Company Muster Roll

for May & June, 1864

Present or absent Absent

Stoppage, \$ 100 for

Due Gov't, \$ 100 for

Valuation of horse, \$ 100

Valuation of horse equipments, \$ 100

Remarks: Due US for creduance
lost 52 cents. Sick in
Genl Hospl

Book mark:

Donnelly

(358)

Copyist.

W 1 Cav. | U.S.C.T.

Woodhouse

Plt., Co., 1. Reg't U. S. Col'd Cavalry

Appears on a
Detachment Muster Roll

of the organization named above

for May & June, 1864.

Station Battlefield Hosp near Petersburg Va

Present or absent Not stated

Stoppage, \$ 100 for

Due Gov't, \$ 100 for

Valuation of horse, \$ 100

Valuation of horse equipments, \$ 100

Remarks: Descriptive roll not sent

Book mark: -----

(341) Hammer Copyist.

W 1 Cav. Mfc. 5

Henry Woodus
Pvt., Co. *H*, Reg't *U.S. Cav.*

Appears on

Hospital Muster Roll

of U. S. A. General Hospital,

at Hampton, Va.,

for *May + June*, 186*4*

Attached to hospital:

When _____, 186 .

How employed _____

Last paid by Maj. _____

to _____, 186 .

Bounty paid \$ *100*; due \$ *100*

Present or absent *Present*

Remarks : _____

Book mark : _____

L. H. Harris

W | 1 Cav. | U.S.C.T.

Louis Woodhouse

Pr, Co. *4*, 1 Reg't U. S. Colored Cav.

Appears on Returns as follows:

June Aug. 8 64 absent
sick

Book mark:

Chas. Sutton

(546)

Copyist.

W

1 Cav. U.S.C.T.

Henry Woodhouse
P. n, Co. G, 1 Reg't U. S. Col'd Cavalry.

Appears on

Company Muster Roll

for July & Aug, 1864.

Present or absent Present

Stoppage, \$ 100 for

Due Gov't, \$ 100 for

Valuation of horse, \$ 100

Valuation of horse equipments, \$ 100

Remarks: Due us for ordnance
52 cents

Book mark:

Donnelly

(358)

Copyist.

W | 1 Cav. | U.S.C.T.

Henry Woodhouse
Pr, Co. G, 1 Reg't U. S. Col'd Cavalry.

Appears on

Company Muster Roll
for *Sept & Oct*, 186 *4*

Present or absent *Present*

Stoppage, \$ *100* for

Due Gov't, \$ *100* for

Valuation of horse, \$ *100*

Valuation of horse equipments, \$ *100*

Remarks:

Book mark:

W. H. Thompson
Copyist.

(358)

W | 1 Cav. | U.S.C.T.

Henry Woodhouse

Priv, Co. G, 1 Reg't U. S. Col'd Cavalry.

Appears on

Company Muster Roll

for *Nov 20*, 186 *4*

Present or absent *Present*

Stoppage, \$ *100* for

Due Gov't, \$ *100* for

Valuation of horse, \$ *100*

Valuation of horse equipments, \$ *100*

Remarks:

Book mark:

W. H. Thompson
(358) Copyist.

N | 1 Cav. | U.S.C.T.

Henry Woodhouse

Pvt, Co. G, 1 Reg't U. S. Col'd Cavalry.

Appears on

Company Muster Roll

for *Jany & Guby*, 186 5.

Present or absent *Present*

Stoppage, \$ 100 for

Due Gov't; \$ 100 for

Valuation of horse, \$ 100

Valuation of horse equipments, \$ 100

Remarks:

Book mark:

(358)

W. H. Thompson
Copyist.

W | 1 Cav. | U.S.C.T.

Henry Woodhouse
Pr, Co. G, 1 Reg't U. S. Col'd Cavalry.

Appears on

Company Muster Roll

for *March & April*, 1865.

Present or absent *Present*.

Stoppage, \$ 100 for

Due Gov't, \$ 100 for

Valuation of horse, \$ 100

Valuation of horse equipments, \$ 100

Remarks:

Book mark:

W. A. Thompson
(358) Copyist.

N | 1 Cav. | U.S.C.T.

Henry Woodhouse

Priv, Co. G, 1 Reg't U. S. Col'd Cavalry.

Appears on

Company Muster Roll

for *May & June*, 1865.

Present or absent *Present*

Stoppage, \$ *100* for

Due Gov't, \$ *100* for

Valuation of horse, \$ *100*

Valuation of horse equipments, \$ *100*

Remarks:

Book mark: -----

W. H. Thompson
(358) Copyist.

W | 1 Cav. | U.S.C.T.

Henry Woodhouse

Pr, Co. G, 1 Reg't U.S. Col'd Cavalry.

Appears on

Company Muster Roll

for *July & Aug*, 1865.

Present or absent

Stoppage, \$ 100 for

Due Gov't, \$ 75 for *Ordinance*

Valuation of horse, \$ 100

Valuation of horse equipments, \$ 100

Remarks:

Book mark:

(358)

W. H. Thompson
Copyist.

A | 1 Cav. | U.S.C.T.

Henry Woodhouse

Priv., Co. G, 1 Reg't U. S. Col'd Cavalry.

Appears on

Company Muster Roll

for Sept & Oct, 1863.

Present or absent present

Stoppage, \$ 100 for

Due Gov't, \$ 100 for

Valuation of horse, \$ 100

Valuation of horse equipments, \$ 100

Remarks:

[Empty lines for remarks]

Book mark:

[Empty line for book mark]

Moy

(358)

Copyist.

N | 1 Cav. | U.S.C.T.

Henry Woodhouse
Priv., Co. G, 1 Reg't U.S. Col'd Cavalry.

Appears on

Company Muster Roll

for *Nov & Dec*, 1863.

Present or absent *present*

Stoppage, \$ *100* for

Due Gov't, \$ *100* for

Valuation of horse, \$ *100*

Valuation of horse equipments, \$ *100*

Remarks:

Book mark:

(358)

May
Copyist.

A | 1 Cav. | U.S.C.T.

Henry Woodhouse
Priv, Co. *G*, 1 Reg't U. S. Col'd Cavalry.

Appears on Co. Muster-out Roll, dated
Mazos Santiago Tx, Feb 4, 1866.
 Muster-out to date *Feb 4, 1866.*
 Last paid to *Aug 31, 1865.*

Clothing account:

Last settled _____, 186 ; drawn since \$ _____ 100
 Due soldier \$ _____ 100; due U. S. \$ *93* ⁰⁰/₁₀₀
 Am't for cloth'g in kind or money adv'd \$ _____ 100

Due U. S. for arms, equipments, &c., \$ _____ 100

Bounty paid \$ _____ 100; due \$ _____ 100

Remarks: *Joined at Org. Org.*

Book mark : _____

(361)

Moy

Copyist.

Wooders, Henry

1 U.S.C. & V.
Reg't

, Co. ,

Enclosures.

Bed Cards	Descriptive Lists
Burial Records	Final Statements
Certs. of Dis. for Discharge	Furloughs
C. M. Charges	Med. Des. Lists
Med. Certificates	Orders

Other papers relating to—

Admission to Hosp'l	Furlough
Casualty Sheet (Officer's)	Med. Examination
Confinement	Misc. Information
Contracts	Pay or Clothing
Death or Effects	Personal Reports
Desertions	Rank
Discharge from Hosp'l	Transfer to Hosp'l
Discharge from Service	Transfer to V. R. C.
Duty	Transportation

Fort Monroe Va
Aug 17th 1864

D. W. Shelly
Pay for Mar

Subscribed now

Office of the Provost Marshal,

Head Quarters Dept. of Virginia & North Carolina,

Fort Monroe, Va.

Aug 17 1864

Wooders

Dr. J. Gerrard
Comdg. Geneyrous
Newport News Va

I have the
pleasure to forward herewith the following
named Exhibited from the Hospital
received from H. S. Seal Hospital
Newport News Va. to be sent to our Regt for
duty.

Jerry Wooders 1st Lt. U.S.A. / or
Please acknowledge receipt

Very Respectfully,
Wm. S. Serrano
J. W. Shelly
Lieut and Actg
Prov. Marshal

1910

Woodhouse Owen

Co I, 1 U. S. Col'd Cav.

Personal papers herein.

Private Private

CARD NUMBERS.

1	5312097	26
2	5312168	27
3	5312244	28
4	5312321	29
5	5312398	30
6	5300564	31
7	5312472	32
8	5312562	33
9	5312668	34
10	5312777	35
11	5312881	36
12	5312980	37
13	5313080	38
14	5313175	39
15	5313266	40
16	5313358	41
17	9086683	42
18	9086810	43
19	40725519	44
20		45
21		46
22		47
23		48
24		49
25		50

Book Mark: 740-1884. 250,272

See also

21 | 1 Cav. | U.S.C.T.

Owen Woodhouse

....., Co. I, 1 Reg't U.S. Col'd Cav.

Appears on

Company Descriptive Book

of the organization named above.

DESCRIPTION.

Age 44 years; height 5 feet 9 inches.

Complexion Dark

Eyes; Dark hair Dark

Where born Princess Anne Co. Va.

Occupation Laborer

ENLISTMENT.

When Dec. 13th 1863

Where Norfolk Va.

By whom Capt. H. Brown, term 3 y'rs.

Remarks: Detained on Duty at
U. C. S. per Ord. No. 49 from
Hq. 2^d 3^d Div. Aug. 1st 1865
Returned to duty with Company
May 20th 65

Duggan

H. | **1 Cav. | U.S.C.T.**

Owen Woodhouse

....., Co. *I.*, 1 Reg't U.S. Col'd Cav.

Appears on

Company Descriptive Book

of the organization named above.

DESCRIPTION.

Age *44* years; height *5* feet *9* inches.

Complexion *Dark*

Eyes; *Dark* hair *Dark*

Where born *Princess Ann Co. Va.*

Occupation *Laborer*

ENLISTMENT.

When *Dec. 17th 1863*

Where *Norfolk*

By whom *Capt. Brown*; term *3* y'rs.

Remarks:

.....

.....

.....

.....

.....

.....

.....

.....

.....

.....

.....

.....

.....

.....

.....

.....

.....

.....

.....

.....

.....

.....

.....

.....

.....

Daggett

W | 1 Cav. | U.S.C.T.

Owen Woodhouse

Private, Co. *I*, 1 Reg't U. S. Col'd Cavalry.

Age *44* years.

Appears on

Company Muster-in Roll

of the organization named above. Roll dated

Camp Hamilton Va, Dec. 22, 186*3*.

Muster-in to date *Dec. 22*, 186*3*.

Joined for duty and enrolled:

When *Dec. 13th*, 186*3*.

Where *Norfolk Va.*

Period *3* years.

Valuation of horse, \$ *100*

Valuation of horse equipments, \$ *100*

Remarks:

Book mark:

M.A. Michaels

(356)

Copyist.

W. | 1 Cav. | U.S.C.T.

Owen Woodhouse

Private, Co. I, 1 Reg't U. S. Col'd Cavalry.

Appears on

Company Muster Roll

for *Dec. 22^d to 31st*, 1863.

Present or absent *present*

Stoppage, \$ 100 for

Due Gov't, \$ 100 for

Valuation of horse, \$ 100

Valuation of horse equipments, \$ 100

Remarks:

Book mark:

M. A. Michaels

(358)

Copyist.

W | 1 Cav. | U.S.C.T.

Owen Woodhouse

Private, Co. I, 1 Reg't U. S. Col'd Cavalry.

Appears on

Company Muster Roll

for *Aug & Febr*, 1864.

Present or absent *present*

Stoppage, \$ *100* for

Due Gov't, \$ *100* for

Valuation of horse, \$ *100*

Valuation of horse equipments, \$ *100*

Remarks:

Book mark:

M. A. Michaels

(358)

Copyist.

M

1 Cav. U.S.C.T.

Owen Woodhouse

Private, Co. I, 1 Reg't U. S. Col'd Cavalry.

Appears on

Company Muster Roll

for *March & Apr.*, 1864.

Present or absent *Present*

Stoppage, \$ 100 for

Due Gov't, \$ 100 for

Valuation of horse, \$ 100

Valuation of horse equipments, \$ 100

Remarks:

Book mark:

M. A. Michaels

(358)

Copyist.

W | 1 Cav. | U.S.C.T.

Owen Woodhouse

Private, Co. I, 1 Reg't U. S. Col'd Cavalry.

Appears on

Company Muster Roll

for *May & June*, 1864.

Present or absent *Present*

Stoppage, \$ *100* for

Due Gov't, \$ *100* for

Valuation of horse, \$ *100*

Valuation of horse equipments, \$ *100*

Remarks:

Book mark:

M.A. Michaels

(358)

Copyist.

W 1 Cav | **U.S.C.T.**

Irven Woodhouse
Bat, Co. D, 1 Reg't U. S. Col'd Cavalry

Appears on a

Detachment Muster Roll

of the organization named above

for May June, 1864

Station Wilson's Landing, Va

Present or absent Present

Stoppage, \$ 100 for

Due Gov't, \$ 100 for

Valuation of horse, \$ 100

Valuation of horse equipments, \$ 100

Remarks:

Book mark:

(344) Hammer Copyist.

W | 1 Cav. | U.S.C.T.

Owen Woodhouse

Private, Co. I, 1 Reg't U. S. Col'd Cavalry.

Appears on

Company Muster Roll

for *July & Aug.*, 186*4*.

Present or absent *present*

Stoppage, \$ *100* for

Due Gov't, \$ *100* for

Valuation of horse, \$ *100*

Valuation of horse equipments, \$ *100*

Remarks:

Book mark:

M. A. Michaels
Copyist.

(358)

W | 1 Cav. | U.S.C.T.

Owen Woodhouse

M, Co. I, 1 Reg't U. S. Col'd Cavalry.

Appears on

Company Muster Roll

for *Sept & Oct*, 186 *4*

Present or absent *Present*

Stoppage, \$ 100 for

Due Gov't, \$ 100 for

Valuation of horse, \$ 100

Valuation of horse equipments, \$ 100

Remarks:

Book mark: -----

(358)

C. W. ...
Copyist.

W | 1 Cav. | U.S.C.T.

Owen Woodhouse

W, Co. I, 1 Reg't U. S. Col'd Cavalry.

Appears on

Company Muster Roll

for *Nov & Dec*, 186 *4*

Present or absent *Present*

Stoppage, \$ *100* for

Due Gov't, \$ *100* for

Valuation of horse, \$ *100*

Valuation of horse equipments, \$ *100*

Remarks:

Book mark: -----

Leuter
Copyist.

W | 1 Cav. | U.S.C.T.

Owen Woodhouse

No, Co. I, 1 Reg't U. S. Col'd Cavalry.

Appears on

Company Muster Roll

for *Lamy & Feb*, 1865.

Present or absent *Present*

Stoppage, \$ *100* for

Due Gov't, \$ *100* for

Valuation of horse, \$ *100*

Valuation of horse equipments, \$ *100*

Remarks:

Book mark:

Leuty
Copyist.

W | 1 Cav. | U.S.C.T.

Owen Woodhouse

W, Co. I, 1 Reg't U. S. Col'd Cavalry.

Appears on

Company Muster Roll

for *Mar & Apr*, 1865.

Present or absent *Present*

Stoppage, \$ 100 for

Due Gov't, \$ 100 for

Valuation of horse, \$ 100

Valuation of horse equipments, \$ 100

Remarks:

Book mark:

(358)

Cutter
Copyist.

W | 1 Cav. | U.S.C.T.

Owen Woodhouse

No., Co. I, 1 Reg't U. S. Col'd Cavalry.

Appears on

Company Muster Roll

for *May & June*, 1865.

Present or absent *Present*

Stoppage, \$ *100* for

Due Gov't, \$ *100* for

Valuation of horse, \$ *100*

Valuation of horse equipments, \$ *100*

Remarks:

Book mark:

W. W. Woodhouse
Copyist.

(358)

W | 1 Cav. | U.S.C.T.

Owen Woodhouse

Plt, Co. I, 1 Reg't U. S. Col'd Cavalry.

Appears on

Company Muster Roll

for July & Aug, 1865.

Present or absent Present

Stoppage, \$ 100 for

Due Gov't, \$ 100 for

Valuation of horse, \$ 100

Valuation of horse equipments, \$ 100

Remarks: Due Us for Advance \$150

Book mark:

Copyist.

(358)

77. | 1 Cav. | U.S.C.T.

Owen Woodhouse,

Pr., Co. I, 1 Reg't U. S. Col'd Cavalry.

Appears on

Company Muster Roll

for Sept - Oct., 1865.

Present or absent absent

Stoppage, \$ 100 for

Due Gov't, \$ 100 for

Valuation of horse, \$ 100

Valuation of horse equipments, \$ 100

Remarks: D. S. for A. O. No.
7, N. L. 3rd Div. 25th Cav.
Aug. 24/65.

Book mark:

(358)

Kelley, Copyist.

No. 1 Cav. U.S.C.T.

Owen Woodhouse.

Private, Co. I, 1 Reg't U. S. Col'd Cavalry.

Appears on

Company Muster Roll

for Nov. + Dec., 1865.

Present or absent Absent

Stoppage, \$ 100 for

Due Gov't, \$ 100 for

Valuation of horse, \$ 100

Valuation of horse equipments, \$ 100

Remarks On detached service
D.O. No. 7, Hd. Qrs. 3rd Div.
25th A.C. Aug. 24/65.

Book mark:

Kelly

(358)

Copyist.

W. | **1 Cav.** | **U.S.C.T.**

Owen Woodhouse

Por, Co. *I.*, 1 Reg't U. S. Colored Cav.

Appears on Returns as follows:

Sept to Dec 1863. about
Det Ser. at Mill Station for
S.O. No. 7 Station 3rd Div 25 al.
Aug 24/65.

Book mark :

W. J. Shaw

(546)

Copyist.

W. | **1 Cav.** | **U.S.C.T.**

Omer Woodhouse

Pr., Co. *I*, 1 Reg't U. S. Col'd Cavalry.

Appears on **Co. Muster-out Roll**, dated

Orizaba Santiago, Tex., *Feb. 4*, 1866.

Muster-out to date *Feb. 4*, 1866.

Last paid to *Aug. 31*, 1865.

Clothing account:

Last settled _____, 186 ; drawn since \$ _____ 100

Due soldier \$ _____ 100; due U. S. \$ *25.57* / 100

Am't for cloth'g in kind or money adv'd \$ _____ 100

Due U. S. for arms, equipments, &c., \$ _____ 100

Bounty paid \$ _____ 100; due \$ _____ 100

Remarks: *Joined at Orizaba.*

Book mark: *740 = 1884, 250, 272.*

(361)

Kelley

Copyist.

1517

Woodward, John

Coast, 1 U. S. Col'd Cav.

Private Private

CARD NUMBERS.

1	5299548	26
2	5299541	27
3	5305840	28
4	5305940	29
5	5306054	30
6	5306157	31
7	5306254	32
8	5306358	33
9	5300698	34
10	5306552	35
11	9086159,	36
12	40725571	37
13		38
14		39
15		40
16		41
17		42
18		43
19		44
20		45
21		46
22		47
23		48
24		49
25		50

Book Mark

See also

N. | **1 Cav. U.S.C.T.**

John Woodward.

....., Co. *D.*, 1 Reg't U.S. Col'd Cav.

Appears on

Company Descriptive Book

of the organization named above.

DESCRIPTION.

Age *18* years; height *5* feet..... inches.

Complexion *Blk.*

Eyes; *Blk.* hair *Blk.*

Where born..... *Ny.*

Occupation *Farmer.*

ENLISTMENT.

When *Oct. 4/64*

Where *Jamaica*

By whom *St. Helen*; term *1* y'rs.

Remarks: *Mustered at*

Jamaica by St. Helen

Oct 4-64

Clothing \$25.04

Bounty Pd \$33 ³³/₁₀₀

Dickerson.

N. | **1 Cav.** | **U.S.C.T.**

John Woodward
 Appears with rank of Br. on

Muster and Descriptive Roll of a Detachment of U. S. Vols. forwarded

for the 1 Reg't U. S. Col'd Cavalry. Roll dated

Nov 20th Decr., 1864.

Where born Kentucky

Age 28 y'rs; occupation Farmer

When enlisted Dec 11, 1864

Where enlisted Jamaica

For what period enlisted 1 years.

Eyes Black; hair Black

Complexion Black; height 3 ft. 0 in.

When mustered in Decr., 1864

Where mustered in Jamaica

Bounty paid \$ 33 ¹⁰⁰; due \$ 100

Where credited 1st Regt. U.S. Col'd Cavalry

Company to which assigned Co. D. Jamaica

Remarks : _____

Book mark : _____

(339) George Copyist.

W | **1 Cav. | U.S.C.T.**

John Woodard

Appears with rank of *S. V.* on

Muster and Descriptive Roll of a Detachment of U. S. Vols. forwarded

for the 1 Reg't U. S. Col'd Cavalry. Roll dated

Tompkinsville, S. Oct. 4, 1864.

Where born *Kentucky*

Age *26* y'rs; occupation *Farmer*

When enlisted *Oct. 4*, 1864.

Where enlisted *Tompkinsville, S.*

For what period enlisted *1* years.

Eyes *Blue*; hair *Black*

Complexion *Black*; height *5* ft. $\frac{1}{2}$ in.

When mustered in *Oct. 4*, 1864.

Where mustered in *Tompkinsville, S.*

Bounty paid \$ *33* $\frac{33}{100}$; due \$ $\frac{100}{100}$

Where credited *Richmond Co.*

Company to which assigned *1st. Co. 1st. Regt. S. V.*

Remarks : _____

Book mark : _____

(339)

Specure

Copyist.

1 | **1 Cav. | U.S.C.T.**

Robert Howard

1st, Co. D, 1 Reg't U. S. Col'd Cavalry.

Appears on

Company Muster Roll

for *Nov 1864*, 186*4*.

Present or absent *Present*

Stoppage, \$ *100* for

Due Gov't, \$ *100* for

Valuation of horse, \$ *100*

Valuation of horse equipments, \$ *100*

Remarks: *Muster + Absence
None not recd. Receipt*

Book mark:

Alman

71 | 1 Cav. | U.S.C.T.

John H. Ward

1st, Co. D, 1 Reg't U. S. Col'd Cavalry.

Appears on

Company Muster Roll

for *June 1865*, 1865.

Present or absent *Present*

Stoppage, \$ *100* for

Due Gov't, \$ *100* for

Valuation of horse, \$ *100*

Valuation of horse equipments, \$ *100*

Remarks: *Has due on En-*
-listment

Book mark :

(358)

Lubans

Copyist.

H | 1 Cav. | U.S.C.T.

Asin Noocand

Asin, Co. D, 1 Reg't U. S. Col'd Cavalry.

Appears on

Company Muster Roll

for *May - April*, 186*5*.

Present or absent *Present*

Stoppage, \$ *100* for

Due Gov't, \$ *100* for

Valuation of horse, \$ *100*

Valuation of horse equipments, \$ *100*

Remarks:

Book mark:

(358)

Abrams

Copyist.

A | 1 Cav. | U.S.C.T.

Robert Woodward

Mr, Co. D, 1 Reg't U. S. Col'd Cavalry.

Appears on

Company Muster Roll

for *May & June*, 186*7*

Present or absent *Present*

Stoppage, \$ *100* for

Due Gov't, \$ *100* for

Valuation of horse, \$ *100*

Valuation of horse equipments, \$ *100*

Remarks:

Book mark:

W. H. Adams

(358)

Copyist.

H | 1 Cav. | U.S.C.T.

John Woodward

No. 1, Co. D, 1 Reg't U. S. Col'd Cavalry.

Appears on

Company Muster Roll

for *Amey King*, 186*5*.

Present or absent *Present*

Stoppage, \$ *100* for

Due Gov't, \$ *100* for

Valuation of horse, \$ *100*

Valuation of horse equipments, \$ *100*

Remarks:

Book mark:

(358)

Libman

Copyist.

W | **1 Cav.** | **U.S.C.T.**

John Woodward
Priv., Co. D, 1 Reg't U. S. Col'd Cavalry.

Appears on

Company Muster Roll

for Sept. & Oct., 1865.

Present or absent

Stoppage, \$ 100 for

Due Gov't, \$ 100 for

Valuation of horse, \$ 100

Valuation of horse equipments, \$ 100

Remarks: Discharged Octo. 24
1865, on expiration of term
of service

Book mark:

R. E. Wilson

(358)

Copyist.

N | 1 Cav. | U.S.C.T.

Com Woodward

Am. Co., 1 Reg't U. S. Colored Cav.

Appears on Returns as follows:

Oct 1863. Discharged

Oct 4 1863. Brazos

*Santiago Tex. expiration
of term of service*

Book mark : _____

W. P. Patton

(546)

Copyist.

N | *1 Cav.* | **U.S.C.T.**

John Woodward
Co. D, 1 Reg't U. S. Col'd Cav

Appears on an

Individual Muster-out Roll

of the organization named above. Roll dated

Crazo Santiago, Tex, Oct 4, 1865.

Muster-out to date *Oct. 4, 1865.*

Last paid to *Aug 31, 1865.*

Clothing account:

Last settled _____, 186 _____; drawn since \$ _____ 100

Due soldier \$ *34 90* / 100; due U. S. \$ _____ 100

Am't for cloth'g in kind or money adv'd \$ _____ 100

Due U. S. for arms, equipments, &c., \$ _____ 100

Bounty paid \$ *33 33* / 100 due \$ *66 66* / 100

Remarks: *Bounty paid \$ 33.33*

Bounty due 66.66

Due soldier for clothing not drawn \$ 34.90

Mustered out by reason of expiration of term of service.

Book mark: _____

Jaxton

W | **1 Cav.** | **U.S.C.T.**

John Woodward
 Priv., Co. *D*, 1 Reg't U. S. Col'd Cavalry.

Appears on **Co. Muster-out Roll**, dated
Brazos Santiago Tex, Feb. 4, 1866.

Muster-out to date 186 .
 Last paid to 186 .

Clothing account:

Last settled 186 ; drawn since \$ $\overline{100}$
 Due soldier \$ $\overline{100}$; due U. S. \$ $\overline{100}$
 Am't for cloth'g in kind or money adv'd \$ $\overline{100}$

Due U. S. for arms, equipments, &c., \$ $\overline{100}$
 Bounty paid \$ $33 \frac{33}{100}$; due \$ $\overline{100}$

Remarks: *Joined as recruit Nov. 14, 1864*
Mustered out on expiration of enlist-
ment Oct. 4, 1865 - Final statement
furnished Oct. 4, 1865

Book mark :

R. E. Wilson
 (361) Copyist.

Stoddard, John

Sgt., Co. _____, Reg't *156, 1st*

3 Enclosures.

Bed Cards	Final Statements
Burial Records	Furloughs or L. of A.
Certs. of Dis. for Discharge	Med. Certificates
C. M. Charges	Med. Des. Lists
Descriptive Lists	Orders
Discharge Certificates	Pris. of War Record
Enlistment Papers	Resignations

Other papers relating to—

Admission to Hosp'l	Furlough or L. of A.
Casualty Sheet	Med. Examination
Confinement	Misc. Information /
Contracts	Pay or Clothing
Death or Effects	Personal Reports
Desertion	Rank
Discharge from Hosp'l	Transfer to Hosp'l
Discharge from Service	Transfer to V. R. C.
Duty	Transportation

NOTE 1.—This blank will be used for both enlistments and re-enlistments—enlistment of veterans, &c., &c., in the volunteer service. They will be made out in duplicate in all cases—one to accompany the recruiting return of the superintendent (not the recruiting officer) to the Adjutant General, and one to accompany the accounts of the officer who pays bounty, &c. The Regiment and Company in which the soldier last served should be given on the back.

NOTE 2.—An enlistment holds to service. A muster-in must, in all cases, precede payment of pay, bounty, pension, &c. A muster-in roll must, in all cases, be filed in the Adjutant General's Office as evidence of muster-in. The mustering officer, commissary, or assistant commissary of musters, as the case may be, will countersign both enlistments as having mustered the soldier into the service of the United States before either of them is given to the disbursing officer.

DECLARATION OF RECRUIT.

John Woodard desiring to VOLUNTEER as a Soldier in the Army of the United States, for the term of ~~THREE~~ ^{one} YEARS, Do Declare, That I am *lighteen* years and _____ months of age; that I have never been discharged from the United States service on account of disability or by sentence of a court martial, or by order before the expiration of a term of enlistment; and I know of no impediment to my serving honestly and faithfully as a soldier for ~~three~~ years.

GIVEN at *Emporium, S. D.* the *4th* day of *Oct 1864*

Witness: *M. A. ...*

John Woodard
[Signature]

Volunteered at *Emporium, S. D.*
By *J. A. Helburn*
1st Regt of U.S.C. Cavalry
Discharged _____, 18____
enlistment; last served in Company ()
No. *2123*
John Woodard
Oct 14 1864
1st Regt of U.S.C. Cavalry

CONSENT IN CASE OF MINOR.

I, _____, Do CERTIFY, That I am the _____ of _____; that the said _____ is _____ years of age; and I do hereby freely give my CONSENT to his volunteering as a SOLDIER in the ARMY OF THE UNITED STATES for the period of THREE YEARS.

GIVEN at _____ the _____ day of _____

Witness: _____

VOLUNTEER ENLISTMENT.

STATE OF

New York



COUNTY OF

Richmond

I, *John Woodard (Col)*, born in _____,
 in the State of *Kentucky*, aged *Eighteen* years,
 and by occupation a *Farmer*, DO HEREBY ACKNOWLEDGE to have
 volunteered this *fourth* day of *Oct*, 1864,
 to serve as a **Soldier** in the **Army of the United States of America**, for
 the period of ~~THREE~~ *one* **YEARS**, unless sooner discharged by proper authority:
 Do also agree to accept such bounty, pay, rations, and clothing, as are, or may be,
 established by law for volunteers. And I, *John Woodard*, do
 solemnly swear, that I will bear true faith and allegiance to the **United States
 of America**, and that I will serve them honestly and faithfully against all their
 enemies or opposers whomsoever; and that I will observe and obey the orders of
 the President of the United States, and the orders of the officers appointed over
 me, according to the Rules and Articles of War.

Sworn and subscribed to, at *Franklinville* in
 this *4th* day of *Oct*, 1864, *John Woodard*

BEFORE *Wm. Allen*

I CERTIFY, ON HONOR, That I have carefully examined the above-named Volunteer, agreeably
 to the General Regulations of the Army, and that, in my opinion, he is free from all bodily defects and
 mental infirmity, which would in any way disqualify him from performing the duties of a soldier.

W. F. Downing
A. A. Surgeon, U.S.A.
 EXAMINING SURGEON.

I CERTIFY, ON HONOR, That I have minutely inspected the Volunteer *John Woodard*
 previously to his enlistment, and that he was entirely sober when enlisted; that, to the best of my
 judgment and belief, he is of lawful age; and that, in accepting him as duly qualified to perform the
 duties of an able-bodied soldier, I have strictly observed the Regulations which govern the recruiting
 service. This soldier has *Blk* eyes, *Blk* hair, *Blk* complexion, is *5*
 feet *1/2* inches high.

Regiment of _____ Volunteers,
 RECRUITING OFFICE

(A. G. O. No. 74 & 76.)

Mustered into the service of the United States, for three years or during the war, from date of enlistment, in Company
1st Regiment of *N. Y.* Volunteers, on the *4th* day of *Oct*, 1864, at *Franklinville*

John Woodard
Wm. Allen

NOTE 1.—This blank will be used for both enlistments and re-enlistments—enlistment of veterans, &c., &c., in the volunteer service. They will be made out in duplicate in all cases—one to accompany the recruiting return of the superintendent (not the recruiting officer) to the Adjutant General, and one to accompany the accounts of the officer who pays bounty, &c. The Regiment and Company in which the soldier last served should be given on the back.

NOTE 2.—An enlistment holds to service. A muster-in must, in all cases, precede payment of pay, bounty, pension, &c. A muster-in roll must, in all cases, be filed in the Adjutant General's Office as evidence of muster-in. The mustering officer, commissary, or assistant commissary of musters, as the case may be, will countersign both enlistments as having mustered the soldier into the service of the United States before either of them is given to the disbursing officer.

DECLARATION OF RECRUIT.

I, John Woodard, desiring to VOLUNTEER as a Soldier in the Army of the United States, for the term of ~~THREE~~ YEARS, Do Declare, That I am eighteen years and _____ months of age; that I have never been discharged from the United States service on account of disability or by sentence of a court martial, by order before the expiration of a term of enlistment; and I know of no impediment to my serving honestly and faithfully as a soldier for three years.

GIVEN at Wilmington, N. C. the 4th day of Oct, 1864.

Witness: Amant John Woodard

Volunteered at Wilmington, N. C.
By J. A. Nelson
of 3rd Regiment of N. C.

enlistment; last served in Company ()
Reg't of _____

Discharged _____, 18 _____

No. 2517

John Woodard

CONSENT IN CASE OF MINOR.

I, _____, Do CERTIFY, That I am the _____ of _____; that the said _____ is _____ years of age: and I do hereby freely give my CONSENT to his volunteering as a SOLDIER in the ARMY OF THE UNITED STATES for the period of THREE YEARS.

GIVEN at _____ the _____ day of _____

Witness: _____

(A. G. O. No. 74 & 76.)

VOLUNTEER ENLISTMENT.

STATE OF

New York.



COUNTY OF

Richmond

I, *John Woodard "Col"* born in _____,
 in the State of *Kentucky*, aged *Eighteen* years,
 and by occupation a *Farmer*, Do HEREBY ACKNOWLEDGE to have
 volunteered this *fourth* day of *Feb*, 186*4*,
 to serve as a *Soldier* in the **Army of the United States of America**, for
 the period of ~~THREE~~ *one* YEARS, unless sooner discharged by proper authority:
 Do also agree to accept such bounty, pay, rations, and clothing, as are, or may be,
 established by law for volunteers. And I, *John Woodard*, do
 solemnly swear, that I will bear true faith and allegiance to the **United States
 of America**, and that I will serve them honestly and faithfully against all their
 enemies or opposers whomsoever; and that I will observe and obey the orders of
 the President of the United States, and the orders of the officers appointed over
 me, according to the Rules and Articles of War.

Sworn and subscribed to, at *Richmond Ky*
 this *4th* day of *Feb*, 186*4*, by *John Woodard*
 BEFORE *Wm. H. ...*

I CERTIFY, ON HONOR, That I have carefully examined the above-named Volunteer, agreeably
 to the General Regulations of the Army, and that, in my opinion, he is free from all bodily defects and
 mental infirmity, which would in any way disqualify him from performing the duties of a soldier.

W. F. ...
A. A. ...
 EXAMINING SURGEON.

I CERTIFY, ON HONOR, That I have minutely inspected the Volunteer *John Woodard*
 previously to his enlistment, and that he was entirely sober when enlisted; that, to the best of my
 judgment and belief, he is of lawful age; and that, in accepting him as duly qualified to perform the
 duties of an able-bodied soldier, I have strictly observed the Regulations which govern the recruiting
 service. This soldier has *Blk* eyes, *Blk* hair, *Blk* complexion, is *5*
 feet *1/2* inches high.

Regiment of _____ Volunteers,
 RECRUITING OFFICER.

(A. G. O. No. 74 & 76.)

Mustered into the service of the United States, for three years or during the war, from date of enlistment, in Company _____
 1st Col New Regiment of _____ Volunteers, on the *4th* day of *Feb*, 186*4*, at *Richmond Ky*

John Woodard
Wm. H. ...

AFFIDAVIT OF

John Woodard

Dated

Oct 4th

1864.

STATE OF NEW YORK,

County of *Richmond* ss:

I, John Woodard do solemnly swear
that I am between the age of eighteen and forty-five years,
~~and not subject to draft by reason of~~

John Woodard

SWORN TO BEFORE ME,

This *4th* day of *Oct* 1864.

Wm. Allman

Wm. Allman

Mustering Officer.

1516

Worden Francis

Co A, 1 U. S. Col'd Cav.

Private Private

CARD NUMBERS.

1	5305249	26
2	5305316	27
3	5305389	28
4	5305466	29
5	5305542	30
6	5305618	31
7	5305722	32
8	5305812	33
9	5305932	34
10	5306047	35
11	5306150	36
12	5306249	37
13	5306346	38
14	5306441	39
15	5306534	40
16	9086100	41
17		42
18		43
19		44
20		45
21		46
22		47
23		48
24		49
25		50

Book Mark

See also

W. | 1 Cav. | U.S.C.T.

Frank Warden.

....., Co. *D*, 1 Reg't U.S. Col'd Cav.

Appears on

Company Descriptive Book

of the organization named above.

DESCRIPTION.

Age *49* years; height *5* feet *3* inches.

Complexion *Dk.*

Eyes; *Dk.* hair *Dk.*

Where born *Prin Ann Co., Va*

Occupation *Farmer.*

ENLISTMENT.

When *Dec 5/63*

Where *Norfolk Va.*

By whom *Capt Brown*; term *3* y'rs.

Remarks:

.....

.....

.....

.....

.....

.....

.....

Dickerson.

W | **1 Cav. | U.S.C.T.**

Francis Warden

Bt, Co. *D*, 1 Reg't U. S. Col'd Cavalry.

Age *21* years.

Appears on

Company Muster-in Roll

of the organization named above. Roll dated
Camp Hamletta Va Dec 22 1863.

Muster-in to date *Dec 22* 1863.

Joined for duty and enrolled:

When *Dec 5*, 1863.

Where *Norfolk Va*

Period *3* years.

Valuation of horse, \$ 100

Valuation of horse equipments, \$ 100

Remarks: _____

Book mark: _____

E. B. Thompson

(356)

Copyist.

W | **1 Cav.** | **U.S.C.T.**

Francis Worden

Pvt, Co. D, 1 Reg't U. S. Col'd Cavalry.

Appears on

Company Muster Roll

for *from Dec 92 to Dec 31*, 1863.

Present or absent *Present*

Stoppage, \$ *100* for

Due Gov't, \$ *100* for

Valuation of horse, \$ *100*

Valuation of horse equipments, \$ *100*

Remarks:

Book mark:

E. P. Thompson
Copyist.

W | 1 Cav. | U.S.C.T.

Francis Worden

Pvt., Co. D, 1 Reg't U. S. Col'd Cavalry.

Appears on

Company Muster Roll

for Jan & Feb., 1864.

Present or absent Present

Stoppage, \$ 100 for

Due Gov't, \$ 100 for

Valuation of horse, \$ 100

Valuation of horse equipments, \$ 100

Remarks:

Book mark:

E. B. Thompson

(358)

Copyist.

N | 1 Cav. | U.S.C.T.

Francis Warden

Pvt, Co. D, 1 Reg't U. S. Col'd Cavalry.

Appears on

Company Muster Roll

for *Mich & Ape*, 1864.

Present or absent *Present*

Stoppage, \$ 100 for

Due Gov't, \$ 100 for

Valuation of horse, \$ 100

Valuation of horse equipments, \$ 100

Remarks:

Book mark:

E. B. Thompson

(358)

Copyist.

W | 1 Cav. | U.S.C.T.

Francis Warden

Pvt, Co. D, 1 Reg't U. S. Col'd Cavalry.

Appears on

Company Muster Roll

for *May & June*, 1864.

Present or absent *Present*

Stoppage, \$ *100* for

Due Gov't, \$ *100* for

Valuation of horse, \$ *100*

Valuation of horse equipments, \$ *100*

Remarks:

Book mark:

E. B. Thompson

(358)

Copyist.

W | 1 Cav. | U.S.C.T.

Francis Warden

Pvt, Co. D, 1 Reg't U. S. Col'd Cavalry.

Appears on

Company Muster Roll

for July & Aug., 1861.

Present or absent Present

Stoppage, \$ 100 for

Due Gov't, \$ 100 for

Valuation of horse, \$ 100

Valuation of horse equipments, \$ 100

Remarks:

Book mark:

E. B. Thompson
Copyist.

(358)

H | 1 Cav. | U.S.C.T.

Francis Norton

H, Co. D, 1 Reg't U. S. Col'd Cavalry.

Appears on

Company Muster Roll

for *Sept Oct*, 186 *7*.

Present or absent *Present*

Stoppage, \$ 100 for

Due Gov't, \$ 100 for

Valuation of horse, \$ 100

Valuation of horse equipments, \$ 100

Remarks:

Book mark:

Edwards

(358)

Copyist.

7/1 | 1 Cav. | U.S.C.T.

Francis Hadden

Plt, Co. D, 1 Reg't U. S. Col'd Cavalry.

Appears on

Company Muster Roll

for *Nov-1864*, 1864.

Present or absent *Present*

Stoppage, \$ *100* for

Due Gov't, \$ *100* for

Valuation of horse, \$ *100*

Valuation of horse equipments, \$ *100*

Remarks:

Book mark:

E. J. Jones

(358)

Copyist.

A | 1 Cav. | U.S.C.T.

Francis Norden

Pvt, Co. D, 1 Reg't U.S. Col'd Cavalry.

Appears on

Company Muster Roll

for *July only*, 1865.

Present or absent *Present*

Stoppage, \$ *100* for

Due Gov't, \$ *100* for

Valuation of horse, \$ *100*

Valuation of horse equipments, \$ *100*

Remarks:

Book mark:

Alvans

(358)

Copyist.

A-

1 Cav. | U.S.C.T.

Francis Warden

207, Co. D, 1 Reg't U. S. Col'd Cavalry.

Appears on

Company Muster Roll

for *March 1865*, 1865.

Present or absent *Present*

Stoppage, \$ *100* for

Due Gov't, \$ *100* for

Valuation of horse, \$ *100*

Valuation of horse equipments, \$ *100*

Remarks:

Book mark:

James

H | 1 Cav. | U.S.C.T.

Francis Haran

Co, Co. D, 1 Reg't U. S. Col'd Cavalry.

Appears on

Company Muster Roll

for *May June*, 1865.

Present or absent *Present*

Stoppage, \$ 100 for

Due Gov't, \$ 100 for

Valuation of horse, \$ 100

Valuation of horse equipments, \$ 100

Remarks:

Book mark: -----

(358)

W. H. ...

Copyist.

H | 1 Cav. | U.S.C.T.

Francis Warden

Co, Co. D, 1 Reg't U. S. Col'd Cavalry.

Appears on

Company Muster Roll

for *July & Aug*, 186*7*

Present or absent *Present*

Stoppage, \$ *100* for

Due Gov't, \$ *100* for

Valuation of horse, \$ *100*

Valuation of horse equipments, \$ *100*

Remarks:

Book mark: -----

(358)

W. W. Brown

Copyist.

W | 1 Cav. | U.S.C.T.

Francis Hordeu

Priv., Co. D, 1 Reg't U. S. Col'd Cavalry.

Appears on

Company Muster Roll

for *Sept. & Oct.*, 186*5*.

Present or absent *Absent*

Stoppage, \$ *100* for

Due Gov't, \$ *100* for

Valuation of horse, \$ *100*

Valuation of horse equipments, \$ *100*

Remarks: *Sick in Post. N. Braun*
Santiago, since Sept. 29, 1865.

Book mark:

R. E. Wilson

(358)

Copyist.

H | 1 Cav. | U.S.C.T.

Francis Marden

Priv., Co. D, 1 Reg't U. S. Col'd Cavalry.

Appears on

Company Muster Roll

for *Nov. & Dec.*, 186*5*.

Present or absent *Present*

Stoppage, \$ *100* for

Due Gov't, \$ *100* for

Valuation of horse, \$ *100*

Valuation of horse equipments, \$ *100*

Remarks:

Book mark: -----

R. G. Wilson

(358)

Copyist.

H | **1 Cav.** | **U.S.C.T.**

Francis Warden

Priv., Co. *D*, 1 Reg't U. S. Col'd Cavalry.

Appears on **Co. Muster-out Roll**, dated
Brazos Santiago, Tex, Feb. 4, 1866.
Muster-out to date *Feb. 4, 1866.*
Last paid to *Aug. 31, 1866.*

Clothing account:

Last settled....., 186 ; drawn since \$.....100
Due soldier \$.....100; due U. S. \$.....28.78/100
Am't for cloth'g in kind or money adv'd \$.....100

Due U. S. for arms, equipments, &c., \$.....100

Bounty paid \$.....100; due \$.....100

Remarks: *Joined at orig. org.*

Book mark :

R. E. Wilson

(361)

Copyist.

Warrell Henry

Co A, 1 U. S. Col'd Cav.

Private Private

CARD NUMBERS.

1	5301104	26
2	5301173	27
3	5301260	28
4	5301347	29
5	5301433	30
6	5300261	31
7	5301519	32
8	5301606	33
9	5301701	34
10	5301814	35
11	5301919	36
12	5302017	37
13	5302113	38
14	5302207	39
15	5302295	40
16	5302377	41
17	9085825-	42
18	4762-B-1889.	43
19		44
20		45
21		46
22		47
23		48
24		49
25		50

Book Mark: 6074 P.M.Y. June 15-66
 V144 P.127-71. 4762-B-89.
 4762-B-1889.
 See also

24 | **1 Cav. | U.S.C.T.**

Odeury Morrill
Co. A, 1 Reg't U.S. Col'd Cav.

Appears on

Company Descriptive Book

of the organization named above.

DESCRIPTION.

Age 18 years; height 5 feet 5 1/2 inches.

Complexion Wask

Eyes; Black hair Black

Where born Norfolk Va

Occupation Farmer

ENLISTMENT.

When Dec 9th 1863

Where Norfolk Va

By whom Capt Brown; term 3 y'rs.

Remarks: _____

Harrison

W | **1 Cav. | U.S.C.T.**

Henry Powell

Co. A, 1 Reg't U. S. Col'd Cavalry.

Age *18* years.

Appears on

Company Muster-in Roll

of the organization named above. Roll dated

Camp Hamilton, Va. Dec. 22, 1863.

Muster-in to date *Dec. 22*, 1863.

Joined for duty and enrolled:

When *Dec. 9*, 1863.

Where *Norfolk, Va.*

Period *3* years.

Valuation of horse, \$ *100*

Valuation of horse equipments, \$ *100*

Remarks:

Book mark: *4762-13-1889*

O. J. Taylor

(356)

Copyist.

H

1 Cav. U.S.C.T.

Henry Worrell

Pr

Co. A, 1 Reg't U.S. Col'd Cavalry.

Appears on

Company Muster Roll

for *Dec. 22 to Dec. 31*, 1863.

Present or absent *Present*

Stoppage, \$ *100* for

Due Gov't, \$ *100* for

Valuation of horse, \$ *100*

Valuation of horse equipments, \$ *100*

Remarks:

Book mark: -----

O. D. Taylor

(358)

Copyist.

W | 1 Cav. | U.S.C.T.

Henry Norrell

Private, Co. A, 1 Reg't U. S. Col'd Cavalry.

Appears on

Company Muster Roll
for *Jan & Feb*, 186*4*.

Present or absent *Present*

Stoppage, \$ *100* for

Due Gov't, \$ *100* for

Valuation of horse, \$ *100*

Valuation of horse equipments, \$ *100*

Remarks:

Book mark : -----

(358)

O. J. Taylor
Copyist.

H | **1 Cav. | U.S.C.T.**

Henry Horrell

Priv, Co. A, 1 Reg't U. S. Col'd Cavalry.

Appears on

Company Muster Roll

for *March & April*, 1864.

Present or absent *Present*

Stoppage, \$ *100* for

Due Gov't, \$ *100* for

Valuation of horse, \$ *100*

Valuation of horse equipments, \$ *100*

Remarks: *Accl'd. S for Ord-
nance \$ 1.12.*

Book mark:

O. A. Taylor

(358)

Copyist.

W | **1 Cav.** | **U.S.C.T.**

Henry Horrell

Pvt, Co. A, 1 Reg't U. S. Col'd Cavalry.

Appears on

Company Muster Roll

for *May & June*, 1864.

Present or absent *Absent*

Stoppage, \$ *100* for

Due Gov't, \$ *100* for

Valuation of horse, \$ *100*

Valuation of horse equipments, \$ *100*

Remarks: *By G. S. per Order dated June 26th 1864.*

Book mark:

O. P. Taylor

(358)

Copyist.

W | 1 Cav. | U.S.C.T.

Henry Warren
Pvt, Co., 1st Reg't U. S. Col'd Cavalry

Appears on a

Detachment Muster Roll

of the organization named above

for May & June, 1864.

Station In the field Va. near Petersburg

Present or absent Present

Stoppage, \$ 100 for

Due Gov't, \$ 100 for

Valuation of horse, \$ 100

Valuation of horse equipments, \$ 100

Remarks :

Filed with, Warrell, Henry

Book mark :

Hammer

(344)

Copyist.

H

1 Cav. | U.S.C.T.

Henry Horrell

Pr, Co. A, 1 Reg't U. S. Col'd Cavalry.

Appears on

Company Muster Roll

for *July & Aug.*, 1864.

Present or absent *Present*

Stoppage, \$ *100* for

Due Gov't, \$ *100* for

Valuation of horse, \$ *100*

Valuation of horse equipments, \$ *100*

Remarks: *Due U. S. for Ordnance lost \$2.42. Free on or before Apr. 19/61.*

Book mark:

O. T. Taylor

(358)

Copyist.

W | 1 Cav. | U.S.C.T.

Fenny Worell
Privt, Co. A, 1 Reg't U. S. Col'd Cavalry.

Appears on

Company Muster Roll

for Sept. & Oct., 1867.

Present or absent Present

Stoppage, \$ 100 for

Due Gov't, \$ 100 for

Valuation of horse, \$ 100

Valuation of horse equipments, \$ 100

Remarks: Due U.S. for
Ordinance lost
\$242. free on or
before April 19/67

Book mark :

Tolman

(358)

Copyist.

W | 1 Cav. | U.S.C.T.

Terry Worrell
Priv., Co. A, 1 Reg't U. S. Col'd Cavalry.

Appears on

Company Muster Roll

for *Nov. & Dec*, 1864.

Present or absent *Present*

Stoppage, \$ *100* for

Due Gov't, \$ *100* for

Valuation of horse, \$ *100*

Valuation of horse equipments, \$ *100*

Remarks:
.....
.....
.....
.....
.....
.....
.....
.....

Book mark:

(358) *Shuman* Copyist.

W

1 Cav.

U.S.C.T.

Henry Warell

Priv.; Co. A, 1 Reg't U. S. Col'd Cavalry.

Appears on

Company Muster Roll

for Jan'y & Feby, 1865.

Present or absent Present

Stoppage, \$ 100 for

Due Gov't, \$ 100 for

Valuation of horse, \$ 100

Valuation of horse equipments, \$ 100

Remarks:

Book mark: -----

Tobman

(358)

Copyist.

24 | **1 Cav.** | **U.S.C.T.**

Henry Worrell
Priv., Co. A, 1 Reg't U. S. Col'd Cavalry.

Appears on

Company Muster Roll

for March & April, 1865.

Present or absent Present

Stoppage, \$ 100 for

Due Gov't, \$ 100 for

Valuation of horse, \$ 100

Valuation of horse equipments, \$ 100

Remarks:

Book mark : -----

(358) Tobman Copyist.

21 | **1 Cav.** | **U.S.C.T.**

Henry Howell

Private, Co. A, 1 Reg't U. S. Col'd Cavalry.

Appears on

Company Muster Roll

for May & June, 1865.

Present or absent Present

Stoppage, \$ 100 for

Due Gov't, \$ 100 for

Valuation of horse, \$ 100

Valuation of horse equipments, \$ 100

Remarks:

Book mark:

Johnson

W | **1 Cav.** | **U.S.C.T.**

Henry Norrell
Private, Co. A, 1 Reg't U. S. Col'd Cavalry.

Appears on

Company Muster Roll

for July & August, 1865.

Present or absent Present

Stoppage, \$ 100 for

Due Gov't, \$ 100 for

Valuation of horse, \$ 100

Valuation of horse equipments, \$ 100

Remarks:

Book mark:

(358)

Tobman

Copyist.

H | 1 Cav. | U.S.C.T.

Henry Howell

Prof., Co. A, 1 Reg't U. S. Col'd Cavalry.

Appears on

Company Muster Roll

for *Sept and Oct*, 1865.

Present or absent *Present*

Stoppage, \$ *100* for

Due Gov't, \$ *100* for

Valuation of horse, \$ *100*

Valuation of horse equipments, \$ *100*

Remarks:

Book mark:

D. P. Webster

(358)

Copyist.

H | 1 Cav. | U.S.C.T.

Henry Harman

Priv., Co. A, 1 Reg't U. S. Col'd Cavalry.

Appears on

Company Muster Roll

for *Nov and Dec*, 186*7*.

Present or absent *Present*

Stoppage, \$ 100 for

Due Gov't, \$ 100 for

Valuation of horse, \$ 100

Valuation of horse equipments, \$ 100

Remarks:

Filed with Warrell, Henry

Book mark:

D. P. Webster

(358)

Copyist.

N | 1 Cav. | U.S.C.T.

Henry Marrell

Prof., Co. *A*, 1 Reg't U. S. Col'd Cavalry.

Appears on Co. Muster-out Roll, dated

Brazos Santiago Tex, Feb 4, 1866.

Muster-out to date *Feb 4, 1866.*

Last paid to *Aug 21, 1865.*

Clothing account:

Last settled _____, 186 ; drawn since \$ _____ $\frac{100}{100}$

Due soldier \$ _____ $\frac{100}{100}$; due U. S. \$ *6* $\frac{92}{100}$

Am't for cloth'g in kind or money adv'd \$ _____ $\frac{100}{100}$

Due U. S. for arms, equipments, &c., \$ _____ $\frac{100}{100}$

Bounty paid \$ ~~*None*~~ $\frac{100}{100}$; due \$ *100* $\frac{00}{100}$

Remarks: *Joined at Oriskany*
Aug. Free before Apr.
19, 1861

Book mark: *6074 R.M.G. June 15 '66*
(over)

JAN. - 6

5302377

1891

V. 44. P. 27. 71.

O.G. June 14 89. See

14462 = 3 = 89. M.H.

W. 1. Cav. U.S.C.

Henry Worrell
Co. A, 1. Reg't U.S.C.

NOTATION.

Book mark: *4762. Q. 1889.*

War Department,

Adjutant General's Office,

Washington, *June 27, 1889.*

Application for certificate in lieu of lost discharge.

One Certificate *in lieu* furnished.

Rough
Copyist.

(476)

1520

Wright Charles

Co 2, 1 U. S. Col'd Cav.

Private Private

CARD NUMBERS.

1	5299671	26
2	5303071	27
3	5303187	28
4	5303291	29
5	5303392	30
6	5303490	31
7	5303585	32
8	5303674	33
9	5303761	34
10	9083936	35
11	40725532	36
12		37
13		38
14		39
15		40
16		41
17		42
18		43
19		44
20		45
21		46
22		47
23		48
24		49
25		50

Book Mark:

See also

4 | 1 Cav. | U.S.C.T.

Charles Wright

....., Co. B, 1 Reg't U.S. Col'd Cav.

Appears on

Company Descriptive Book

of the organization named above.

DESCRIPTION.

Age 20 years; height 5 feet 9 inches.

Complexion Black

Eyes; Black hair Black

Where born Washington D.C.

Occupation Seaman

ENLISTMENT.

When Nov 26 - 64

Where Wford News

By whom L. Monroy; term 3 y'rs.

Remarks: Bounty paid
\$100.00

.....
.....
.....
.....
.....
.....
.....
.....

Houston

W | **1 Cav. | U.S.C.T.**

Charles Wright

Appears with rank of *Priv* on

Muster and Descriptive Roll of a Detachment of U. S. Vols. forwarded

for the 1 Reg't U. S. Col'd Cavalry. Roll dated

Newport News Va Nov 30, 1864

Where born *Washington D. C*

Age *20* y'rs; occupation *Steward*

When enlisted *Nov 21*, 1864.

Where enlisted *Newport News*

For what period enlisted *5* years.

Eyes *Blk*; hair *Blk*

Complexion *Blk*; height *5* ft. *9* in.

When mustered in *Nov 26*, 1864.

Where mustered in *Newport News*

Bounty paid \$ *100*¹⁰⁰; due \$ *100*¹⁰⁰

Where credited *Com 4 Coy. Dist*

Company to which assigned

Remarks:

Book mark:

(339)

Wright
Copyist.

W

1 Cav.

U.S.C.T.

Charles Knight

P, Co. B, 1 Reg't U. S. Col'd Cavalry.

Appears on

Company Muster Roll

for *Nov. & Dec.*, 1864.

Present or absent *Present*

Stoppage, \$ *100* for

Due Gov't, \$ *100* for

Valuation of horse, \$ *100*

Valuation of horse equipments, \$ *100*

Remarks: *Bounty Paid \$100*

Book mark:

(358)

Shadwell

Copyist.

W | 1 Cav. | U.S.C.T.

Charles Wright

P, Co. B, 1 Reg't U. S. Col'd Cavalry.

Appears on

Company Muster Roll

for *Jan. & Feb.*, 186*5*.

Present or absent *Present*

Stoppage, \$ *100* for

Due Gov't, \$ *100* for

Valuation of horse, \$ *100*

Valuation of horse equipments, \$ *100*

Remarks: *Bounty paid \$100 -*

Book mark:

(358) *Shadlock* Copyist.

W | 1 Cav. | U.S.C.T.

Charles Wright

P, Co. B, 1 Reg't U. S. Col'd Cavalry.

Appears on

Company Muster Roll

for *Mar. & Apr.*, 1865.

Present or absent *Present*

Stoppage, \$ *100* for

Due Gov't, \$ *100* for

Valuation of horse, \$ *100*

Valuation of horse equipments, \$ *100*

Remarks: *Bounty paid \$100 -*

Book mark:

(358)

Shadock

Copyist.

N | 1 Cav. | U.S.C.T.

Charles Wright

P, Co. B, 1 Reg't U. S. Col'd Cavalry.

Appears on

Company Muster Roll

for *May & June*, 186*5*.

Present or absent *Present*

Stoppage, \$ *100* for

Due Gov't, \$ *100* for

Valuation of horse, \$ *100*

Valuation of horse equipments, \$ *100*

Remarks: *Bounty paid \$100-*

Book mark:

(358)

Shadlock

Copyist.

N | 1 Cav. | U.S.C.T.

Charles Wright

P, Co. B, 1 Reg't U. S. Col'd Cavalry.

Appears on

Company Muster Roll

for *July & Aug.*, 1865.

Present or absent *Absent*

Stoppage, \$ *100* for

Due Gov't, \$ *100* for

Valuation of horse, \$ *100*

Valuation of horse equipments, \$ *100*

Remarks: *Bounty paid \$100 -
Post. Hspl. Brazos
Santiago Tex.*

Book mark:

(358)

Shaddock

Copyist.



W | 1 Cav. | U.S.C.T.

Charles Wright

Priv, Co. B, 1 Reg't U. S. Col'd Cavalry.

Appears on

Company Muster Roll

for *Sept & Oct*, 186*7*.

Present or absent *Absent*

Stoppage, \$ *100* for

Due Gov't, \$ *100* for

Valuation of horse, \$ *100*

Valuation of horse equipments, \$ *100*

Remarks: *Absent Hospital*
since Aug 14, 1867.

Book mark:

Carlson

W | 1 Cav. | U.S.C.T.

Charles Wright

Priv, Co. B, 1 Reg't U. S. Col'd Cavalry.

Appears on

Company Muster Roll

for *Nov & Dec*, 186*3*.

Present or absent *absent*

Stoppage, \$ *100* for

Due Gov't, \$ *100* for

Valuation of horse, \$ *100*

Valuation of horse equipments, \$ *100*

Remarks: *In Gen. Hospital since Aug. 14, 1862.*

Book mark:

Franklin

W | 1 Cav. | U.S.C.T.

Charles Wright

Priv, Co. *B*, 1 Reg't U. S. Colored Cav.

Appears on Returns as follows:

Aug 1863. absent sick
Post Hosp. Pragos Santiago

Sept to Dec 1863 absent sick
in Genl Hosp. since Aug
14/63

Book mark:

John Patton

W | **1 Cav.** | **U.S.C.T.**

Charles Wright

Priv, Co. *B*, 1 Reg't U. S. Col'd Cavalry.

Appears on **Co. Muster-out Roll**, dated

Brazos Santiago, Texas, Feby 4, 186*6*.

Muster-out to date *Feby 4*, 186*6*.

Last paid to *Aug 31*, 186*5*.

Clothing account:

Last settled....., 186 ; drawn since \$.....100

Due soldier \$ *21* ^{*95*}/_{*100*}; due U. S. \$.....100

Am't for cloth'g in kind or money adv'd \$.....100

Due U. S. for arms, equipments, &c., \$.....100

Bounty paid \$ *100* 100; due \$.....100

Remarks: *Joined as Recruit.*

Book mark :

Faulkner

(361)

Copyist.

Wright Charles

1st Reg't *156th*
 Co. _____, _____

Enclosures.

Bed Cards	Final Statements
Burial Records	Furloughs or L. of A.
Certs. of Dis. for Discharge	Med. Certificates
C. M. Charges	Med. Des. Lists
Descriptive Lists	Orders
Discharge Certificates	Pris. of War Record
Enlistment Papers	Resignations

Other papers relating to—

Admission to Hosp'l	Furlough or L. of A.
Casualty Sheet	Med. Examination
Confinement	Misc. Information
Contracts	Pay or Clothing
Death or Effects	Personal Reports
Desertion	Rank
Discharge from Hosp'l	Transfer to Hosp'l
Discharge from Service	Transfer to V. R. C.
Duty	Transportation

DECLARATION OF RECRUIT.

I, Charles Wright desiring to VOLUNTEER as a Soldier in the Army of the United States, for the term of THREE YEARS, Do Declare, That I am Twenty years and — months of age; that I have never been discharged from the United States service on account of disability or by sentence of a court-martial, or by order before the expiration of a term of enlistment; and I know of no impediment to my serving honestly and faithfully as a soldier for three years.

GIVEN at Norfolk the 24 day of November 1864

Witness: Wm C. Brown

Charles Wright
marks

NOTE 1.—This blank will be used for both enlistments and re-enlistments—enlistment of veterans, &c., &c., in the volunteer service. They will be made out in duplicate in all cases—one to accompany the recruiting return of the superintendent (not the recruiting officer) to the Adjutant General, and one to accompany the accounts of the officer who pays bounty, &c. The Regiment and Company in which the soldier last served should be given on the back.

NOTE 2.—An enlistment holds to service. A muster-in must, in all cases, precede payment of pay, bounty, pension, &c. A muster-in roll must, in all cases, be filed in the Adjutant General's Office as evidence of muster-in. The mustering officer, commissary, or assistant commissary of musters, as the case may be, will countersign both enlistments as having mustered the soldier into the service of the United States before either of them is given to the disbursing officer.

No. 37
Volunteered at Norfolk News
By W. Monroe 1864
37 Regiment of W. B. S.
1st Regt of U.S.C. Cavalry
Discharged 18

CONSENT IN CASE OF MINOR.

I, _____ Do CERTIFY, That I am the _____ of _____; that the said _____ is _____ years of age; and I do hereby freely give my CONSENT to his volunteering as a SOLDIER in the ARMY OF THE UNITED STATES for the period of THREE YEARS.

GIVEN at _____

Witness: _____ the _____ day of _____

VOLUNTEER ENLISTMENT.

STATE OF

Connecticut



TOWN OF

at Sayre
4th Cong District

I, Chas Wright born in Washington

in the State of Conn aged Twenty years,

and by occupation a Steward Do HEREBY ACKNOWLEDGE to have

volunteered this Twenty fourth day of November 1864

to serve as a **Soldier** in the **Army of the United States of America**, for the

period of **THREE YEARS**, unless sooner discharged by proper authority: Do also

agree to accept such bounty, pay, rations, and clothing, as are, or may be, estab-

lished by law for volunteers. And I, Chas Wright do

solemnly swear, that I will bear true faith and allegiance to the **United States**

of America, and that I will serve them honestly and faithfully against all their

enemies or opposers whomsoever; and that I will observe and obey the orders of

the President of the United States, and the orders of the officers appointed over

me, according to the Rules and Articles of War.

Sworn and subscribed to, at

Newport News

on this 26th day of Nov 1864

Charles X Wright

BEFORE

J. M. Morrow
Lt. 37th U.S.C.T.

I CERTIFY, ON HONOR, That I have carefully examined the above-named Volunteer, agreeably to the General Regulations of the Army, and that, in my opinion, he is free from all bodily defects and mental infirmity, which would in any way disqualify him from performing the duties of a soldier.

W. B. Gray
Asst Surg 1st Regt C.C.
EXAMINING SURGEON.

I CERTIFY, ON HONOR, That I have minutely inspected the Volunteer, Wright previously to his enlistment, and that he was entirely sober when enlisted; that, to the best of my judgment and belief, he is of lawful age; and that, in accepting him as duly qualified to perform the duties of an able-bodied soldier, I have strictly observed the Regulations which govern the recruiting service.

This soldier has Blk eyes, Blk hair, Blk complexion, is 5 feet 9 inches high.

James M. Morrow
Lt 37th Regiment of U.S.C.T. Volunteers,

RECRUITING OFFICER.

Mustered into the service of the United States, in Company First Regiment of Volunteers, on
the 26th day of November, 1864, at Newport News Va
Chas Wright
Company

1521 Army

Wright Jersey

Co K, 1 U. S. Col'd Cav.

Personal papers herein.

Private Private

CARD NUMBERS.

1	5299697	26
2	5299701	27
3	5314040	28
4	5314152	29
5	5314260	30
6	5300613	31
7	5314353	32
8	5314456	33
9	5314545	34
10	5314632	35
11	5300699	36
12	5314735	37
13	9086942	38
14	40725523	39
15		40
16		41
17		42
18		43
19		44
20		45
21		46
22		47
23		48
24		49
25		50

Book Mark: E 13. V. 11830

See also

21 | **1 Cav. | U.S.C.T.**

Dorsey Night

....., Co. *K.*, 1 Reg't U.S. Col'd Cav.

Appears on

Company Descriptive Book

of the organization named above.

DESCRIPTION.

Age *18* years; height *5* feet *6* inches.

Complexion *Blk*

Eyes; *Br* hair *Blk.*

Where born *Clarence N.Y.*

Occupation *Farmer*

ENLISTMENT.

When *Nov 10 "1864*

Where *Buffalo N.Y.*

By whom *Mag Taylor*; term *1* y'rs.

Remarks: *33.33 Bounty paid*

24.50 Clothing

Mustered out by reason

of expiration of term

of service Nov. 17 "1865

Daggett

H

1 Cav. U.S.C.T.

Dorcy Wright

Appears with rank of *Pr* on

Muster and Descriptive Roll of a Detachment of U. S. Vols. forwarded

for the 1 Reg't U. S. Col'd Cavalry. Roll dated

Suffalo N.Y., *Nov 21*, 186 *4*

Where born *Carroll N.Y.*

Age *18* y'rs; occupation *Farmer*

When enlisted *Nov-10*, 186 *4*

Where enlisted *Suffalo N.Y.*

For what period enlisted *1* years.

Eyes *Blk*; hair *Blk*

Complexion *Blk*; height *5* ft. *6* in.

When mustered in *Nov-10*, 186 *4*

Where mustered in *Suffalo N.Y.*

Bounty paid \$ *100*; due \$ *100*

Where credited *Fulton Iron Works Co*

14 Pitt. N.Y.
Company to which assigned

Remarks :

Book mark :

Reed

21

1 Cav. U.S.C.T.

Darcy Wright

Appears with rank of *2d* on

Muster and Descriptive Roll of a Detachment of U. S. Vols. forwarded

for the 1 Reg't U. S. Col'd Cavalry. Roll dated

Fort Island Ct. Vt., Nov-24, 1864

Where born *Clarence Ct. Vt.*

Age *18* y'rs; occupation *Farmer*

When enlisted *Nov. 10*, 1864

Where enlisted *Buffalo*

For what period enlisted _____ years.

Eyes *blk*; hair *blk*

Complexion *blk*; height *5* ft. *6* in.

When mustered in *Nov-10*, 1864

Where mustered in *Buffalo*

Bounty paid \$ *33*^{*33*}/_{*100*}; due \$ *100*

Where credited *4 Cav. Div. Tullon*

Sub. Div.
Company to which assigned _____

Remarks : _____

Book mark : _____

Devo

(339)

Copyist.

H | 1 Cav. | U.S.C.T.

Darcy Knight

Pol, Co. K, 1 Reg't U. S. Col'd Cavalry.

Appears on

Company Muster Roll

for *Nov & Dec*, 186 *4*.

Present or absent *Present*

Stoppage, \$ *100* for

Due Gov't, \$ *100* for

Valuation of horse, \$ *100*

Valuation of horse equipments, \$ *100*

Remarks: *Bounty Paid \$100.00*

Book mark:

Wm. J. ...

W | 1 Cav. | U.S.C.T.

Dossy Wright

Private, Co. K, 1 Reg't U. S. Col'd Cavalry.

Appears on

Company Muster Roll

for *Jan'y & Feb'y*, 1865.

Present or absent *Absent*

Stoppage, \$ 100 for

Due Gov't, \$ 100 for

Valuation of horse, \$ 100

Valuation of horse equipments, \$ 100

Remarks: *Detached S. Co. 172 Hd Qrs
1st USCC for Duty in
Regt Band*

Book mark:

Wm. S. ...

(358)

Copyist.

H | 1 Cav. | U.S.C.T.

Dory Wright
Pol, Co. K, 1 Reg't U. S. Col'd Cavalry.

Appears on

Company Muster Roll

for *March 1862*, 1862.

Present or absent *Absent*

Stoppage, \$ *100* for

Due Gov't, \$ *100* for

Valuation of horse, \$ *100*

Valuation of horse equipments, \$ *100*

Remarks: *Detached to No 172*
Company 1st Regt. Cal. for
Duty in Regt. Band

Book mark:

Vausoren

(358)

Copyist.

of 1 cav. | U.S.C.T.

Worsey Knight
Pvt., Co. 1. Reg't U. S. Col'd Cavly.

Appears on a

Detachment Muster Roll

of the organization named above

for Mar & April, 1865

Station Gettys Station Va

Present or absent not stated

Stoppage, \$ 100 for

Due Gov't, \$ 100 for

Valuation of horse, \$ 100

Valuation of horse equipments, \$ 100

Remarks:

Book mark:

(344)

Hammer

Copyist.

H | 1 Cav. | U.S.C.T.

Davy Wright
Plt, Co. K, 1 Reg't U. S. Col'd Cavalry.

Appears on

Company Muster Roll

for *May & June*, 1865-

Present or absent *Present*

Stoppage, \$ 100 for

Due Gov't, \$ 100 for

Valuation of horse, \$ 100

Valuation of horse equipments, \$ 100

Remarks: *On daily duty in Reg't Band. Due \$5. for Ordnance lost - 0/15-*

Book mark:

T. A. Brown

(358)

Copyist.

W. J. Caw U.S.C.T.

Samy Wright
Pr, Co. *K*, 1 Reg't U. S. Col'd *Caw*

Appears on

Company Muster Roll

for *July & Augt*, 1865.

Present or absent *present*

Stoppage, \$ *100* for

Due Gov't, \$ *100* for

Valuation of horse, \$ *100*

Valuation of horse equipments, \$ *100*

Remarks: *Due Ad. for Ordnance Lost 15 cts*
On daily duty Regt Band

Book mark:

J. Anderson

M

1 Cav. | U.S.C.T.

Dorsey Wright

H, Co. K, 1 Reg't U. S. Col'd Cavalry.

Appears on

Company Muster Roll

for *Sept & Oct*, 186*3*.

Present or absent *Present*

Stoppage, \$ 100 for

Due Gov't, \$ 100 for

Valuation of horse, \$ 100

Valuation of horse equipments, \$ 100

Remarks: *On daily duty
Rgt. Band.*

Book mark:

J. J. ...

(358)

Copyist.

W

1 Cav. U.S.C.T.

Dorsey Wright

Pt., Co. K, 1 Reg't U. S. Col'd Cavalry.

Appears on

Company Muster Roll

for *Nov 17/65*, 186*5*.

Present or absent

Stoppage, \$ 100 for

Due Gov't, \$ 100 for

Valuation of horse, \$ 100

Valuation of horse equipments, \$ 100

Remarks: *Discharged*
Nov 17/65 by reason
of expiration of
term of service

Book mark:

H. Johnson

(358)

Copyist.

M | 1 Cav. | U.S.C.T.

Dorsy Wright

Priv., Co. *K*, 1 Reg't U. S. Colored Cav.

Appears on Returns as follows:

May to Oct 1865. on daily
duty as musician in Reg't Band
Disced Dec 15/64 S.O. 172 Hagre
17500

Nov 1865. Nov 17/65. Proprs
Gen. mustered out by reason
of expiration of term of service

Book mark :

W. D. Sutton

W | 16av | U.S.C.T.

Darsey Wright
Pvt, Co. K, 1 Reg't U. S. Col'd 6av

Appears on an

Individual Muster-out Roll

of the organization named above. Roll dated

Brazos Santiago Tex Nov 17, 1865.

Muster-out to date Nov. 17, 1865.

Last paid to Aug 31, 1865.

Clothing account:

Last settled, 186 . . . ; drawn since \$ 100

Due soldier \$ 32 05 / 100; due U. S. \$ 100

Am't for cloth'g in kind or money adv'd \$ 100

Due U. S. for arms, equipments, &c. } rd. pr G.O. 101 } \$ 300 / 100

Bounty paid \$ 33 33 / 100 due \$ 66 66 / 100

Remarks: Mustered out by reason of expiration of term of service. Due the soldier for U. S. Bounty \$66.66

Book mark:

Daxton

NARA 689

JAN.-5

5300699

★ 1891 ★

Due the Soldier
for clothing not
drawn $\$32 \frac{05}{100}$
Stop for 1 Cav.
Sabre + Belt re-
tained per G.O. 101
\$3.00

W | **1 Cav. | U.S.C.T.**

Mossey Wright

Pl, Co.-----, 1 Reg't U. S. Col'd Cavalry.

Appears on **Co. Muster-out Roll**, dated
Brays Santiago Tex, Feb 4, 1866.

Muster-out to date -----, 186 .
Last paid to -----, 186 .

Clothing account:

Last settled -----, 186 ; drawn since \$-----100
Due soldier \$-----100; due U. S. \$-----100
Am't for cloth'g in kind or money adv'd \$-----100

Due U. S. for arms, equipments, &c., \$-----100

Bounty paid \$-----100; due \$-----100

Remarks: *Joined as recruit*
Mustered out Nov 21/63
at Brays Santiago Texas by
reason of expiration of term
of service.

Book mark: *Discharged Nov 14/63*

L. J. Jones

(361) Copyist.

Wright,

Dorsey-

P, Co. R,

1 Reg't U.S.C. Cav.

3 Enclosures.

Bed Cards	Descriptive Lists
Burial Records	Final Statements
Certs. of Dis. for Discharge	Furloughs
C. M. Charges	Med. Des. Lists
Med. Certificates	Orders

E.V.

2

Other papers relating to—

Admission to Hosp'l	Furlough
Casualty Sheet (Officer's)	Med. Examination
Confinement	Misc. Information
Contracts	Pay or Clothing
Death or Effects	Personal Reports
Desertions	Rank
Discharge from Hosp'l	Transfer to Hosp'l
Discharge from Service	Transfer to V. R. C.
Duty	Transportation

MICROFILM PUBLICATION M 1817

COMPILED MILITARY SERVICE RECORDS
OF VOLUNTEER UNION SOLDIERS WHO
SERVED WITH THE USCT (US COLORED TROOPS)
1ST REGIMENT OF CAVALRY

PERSONAL PAPERS' TARGET SHEET

PLEASE NOTE THE CHECKED INFORMATION ABOUT THE PERSONAL PAPERS IN
THIS FILE:

- NO PERSONAL PAPERS WERE FOUND IN THIS FILE WHEN THE
RECORDS WERE ARRANGED FOR MICROFILMING.
- 3 PERSONAL PAPER(S) FOUND IN THIS FILE WHEN THE RECORDS
WERE ARRANGED FOR MICROFILMING.

NOTE 1.—This blank will be used for both enlistments and re-enlistments—enlistment of veterans, &c., &c., in the volunteer service. They will be made out in duplicate in all cases—one to accompany the recruiting return of the superintendent (not the recruiting officer) to the Adjutant General, and one to accompany the accounts of the officer who pays bounty, &c. The Regiment and Company in which the soldier last served should be given on the back.

NOTE 2.—An enlistment holds to service. A muster-in must, in all cases, precede payment of pay, bounty, pension, &c. A muster-in roll must, in all cases, be filed in the Adjutant General's Office as evidence of muster-in. The mustering officer, commissary, or assistant commissary of musters, as the case may be, will countersign both enlistments as having mustered the soldier into the service of the United States before either of them is given to the disbursing officer.

DECLARATION OF RECRUIT.

I, Corley Wright, desiring to VOLUNTEER as a Soldier in the Army of the United States, for the term of ~~THREE~~ ^{one} YEARS, Do Declare, That I am eighteen years and _____ months of age; that I have never been discharged from the United States service on account of disability or by sentence of a court martial, or by order before the expiration of a term of enlistment; and I know of no impediment to my serving honestly and faithfully as a soldier for ~~three years~~ one year

GIVEN at Buffalo, N.Y. the 10th day of December 1862

William George Whelan Corley Wright

Discharged _____, 18 ____

enlistment; last served in Company () _____ Reg't of _____

By Wm. H. 911 _____
Regiment of U.S. Col. Cav.

Volunteered at Buffalo, N.Y., 1862

1st 11th Regt of Cavalry
No. 1000
Corley Wright

CONSENT IN CASE OF MINOR.

I, _____, DO CERTIFY, That I am the _____ of _____; that the said _____ is _____ years of age; and I do hereby freely give my CONSENT to his volunteering as a SOLDIER in the ARMY OF THE UNITED STATES for the period of THREE YEARS.

GIVEN at _____ the _____ day of _____

Witness: _____

VOLUNTEER ENLISTMENT.

STATE OF

New York

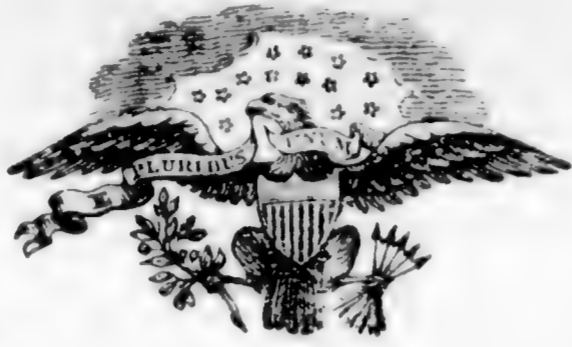

TOWN OF

*Tulton
Scholaric County
11th Dist 241.*

I, *Gary Wright (Colored)*, born in *Clarence*,
in the State of *New York*, aged *eighteen* years,
and by occupation a *Farmer*, Do HEREBY ACKNOWLEDGE to have
volunteered this *fourth* day of *November*, 186*4*,
to serve as a **Soldier** in the **Army of the United States of America**, fo-
the period of ~~THREE~~ ^{one} **YEARS**, unless sooner discharged by proper authority:
Do also agree to accept such bounty, pay, rations, and clothing, as are, or may be,
established by law for volunteers. And I, *Gary Wright*, do
solemnly swear, that I will bear true faith and allegiance to the **United States
of America**, and that I will serve them honestly and faithfully against all their
enemies or opposers whomsoever; and that I will observe and obey the orders of
the President of the United States, and the orders of the officers appointed over
me, according to the Rules and Articles of War.

Sworn and subscribed to, at *Buffalo 24th*
this *10th* day of *November*, 186*4*,
BEFORE *Geo A Haddock*

I CERTIFY, ON HONOR, That I have carefully examined the above-named Volunteer, agreeably
to the General Regulations of the Army, and that, in my opinion, he is free from all bodily defects and
mental infirmity, which would in any way disqualify him from performing the duties of a soldier.

Wm C. ...
EXAMINING SURGEON.

I CERTIFY, ON HONOR, That I have minutely inspected the Volunteer *Gary Wright*
previously to his enlistment, and that he was entirely sober when enlisted; that, to the best of my
judgment and belief, he is of lawful age; and that, in accepting him as duly qualified to perform the
duties of an able-bodied soldier, I have strictly observed the Regulations which govern the recruiting
service. This soldier has *Black* eyes, *Black* hair, *Black* complexion, is *five*
feet *six* inches high.

Geo A Haddock
Regiment of *11th Dist 241* Volunteers,
RECRUITING OFFICER.

(A. G. O. No. 74 & 76.)

Mustered into the service of the United States, for ~~three~~ ^{one} years ~~during the war~~, from date of enlistment, in ~~Company~~
11th Regiment of *Volunteers*, on the *10th* day of *November*, 186*4*, at *Buffalo 24th*

Geo A Haddock
Major 11th Regt 1st DC Dist 241

DECLARATION OF RECRUIT.

I, George Wright, desiring to VOLUNTEER as a Soldier in the Army of the United States, for the term of ^{one year} ~~THREE YEARS~~, Do Declare, That I am eighteen years and _____ months of age; that I have never been discharged from the United States service on account of disability or by sentence of a court martial, or by order before the expiration of a term of enlistment; and I know of no impediment to my serving honestly and faithfully as a soldier for three years. ^{one year}

GIVEN at Buffalo N.Y. the 10th day of November 1864

Williamburg, W. Va.

George Wright

NOTE 1.—This blank will be used for both enlistments and re-enlistments—enlistment of veterans, &c., &c., in the volunteer service. They will be made out in duplicate in all cases—one to accompany the recruiting return of the superintendent (not the recruiting officer) to the Adjutant General, and one to accompany the accounts of the officer who pays bounty, &c. The Regiment and Company in which the soldier last served should be given on the back.

NOTE 2.—An enlistment holds to service. A muster-in must, in all cases, precede payment of pay, bounty, pension, &c. A muster-in roll must, in all cases, be filed in the Adjutant General's Office as evidence of muster-in. The mustering officer, commissary, or assistant commissary of musters, as the case may be, will countersign both enlistments as having mustered the soldier into the service of the United States before either of them is given to the disbursing officer.

ADJUTANT GENERAL'S OFFICE
FILE IN THE REGIMENTAL RECORDS
FOR THE REGIMENTAL ADJUTANT GENERAL
D. R. & P. O.

No. 2566

George Wright
Volunteered at Buffalo N.Y.

November 10th, 1864

By Wm. H. Taylor

1 Regiment of Artillery

enlistment; last served in Company ()

Reg't of _____

Discharged _____, 18 _____

CONSENT IN CASE OF MINOR.

I, _____, Do CERTIFY, That I am the _____ of _____; that the said _____ is _____ years of age; and I do hereby freely give my CONSENT to his volunteering as a SOLDIER in the ARMY OF THE UNITED STATES for the period of THREE YEARS.

GIVEN at _____ the _____ day of _____

Witness: _____

VOLUNTEER ENLISTMENT.

STATE OF

New York

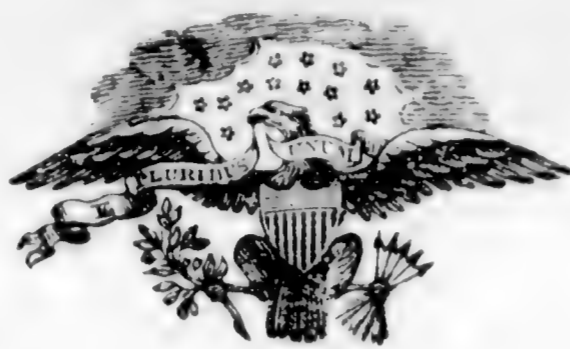

TOWN OF

Tulsa
Schubert County
11th Dist. U.S.

I, Gray Wright (Colored), born in Lawrence,
in the State of New York, aged sixteen years,
and by occupation a Farmer, Do HEREBY ACKNOWLEDGE to have
volunteered this fourth day of November, 1864,
to serve as a **Soldier** in the **Army of the United States of America**, fo-
the period of ~~THREE~~ ^{ONE} **YEARS**, unless sooner discharged by proper authority:
Do also agree to accept such bounty, pay, rations, and clothing, as are, or may be,
established by law for volunteers. And I, Gray Wright do
solemnly swear, that I will bear true faith and allegiance to the **United States**
of America, and that I will serve them honestly and faithfully against all their
enemies or opposers whomsoever; and that I will observe and obey the orders of
the President of the United States, and the orders of the officers appointed over
me, according to the Rules and Articles of War.

Sworn and subscribed to, at Buffalo N.Y.
this fourth day of November, 1864 Gray Wright
BEFORE Geo A Haddock
Major 1st Regt 4th Col 20th Dist N.Y.

I CERTIFY, ON HONOR, That I have carefully examined the above-named Volunteer, agreeably
to the General Regulations of the Army, and that, in my opinion, he is free from all bodily defects and
mental infirmity, which would in any way disqualify him from performing the duties of a soldier.

Geo A Haddock
EXAMINING SURGEON.

I CERTIFY, ON HONOR, That I have minutely inspected the Volunteer Gray Wright
previously to his enlistment, and that he was entirely sober when enlisted; that, to the best of my
judgment and belief, he is of lawful age; and that, in accepting him as duly qualified to perform the
duties of an able-bodied soldier, I have strictly observed the Regulations which govern the recruiting
service. This soldier has Black eyes, Black hair, Black complexion, is five
feet six inches high.

Geo A Haddock
Major 1st Regt 4th Col 20th Dist N.Y.
Regiment of Volunteers,
RECRUITING OFFICER.

(A. G. O. No. 74 & 76.)

Mustered into the service of the United States, for three years ~~including the year~~, from date of enlistment, in Company
1st Regiment of Mississippi Cavalry Volunteers, on the 11th day of November, 1864, at Buffalo, N.Y.

Geo A Haddock
Major 1st Regt 4th Col 20th Dist N.Y.
3rd Regt 1st Dist Infantry Officers

See letter to 2nd Amd. June 9. 74.

[OFFICE INDORSEMENT.]

War Department,

ADJUTANT GENERAL'S OFFICE,

March 25, 1874,

The of
 Put , Co. K, Reg't U. S.
Colored , is reported as follows:—

- Of Company Muster Roll.
- For , 186 , , 186 .
- Company Muster-out Roll.
- , 186 .
- Company Descriptive Book.
- , 186
- Company Morning Reports.
- , 186
- Soldier's Final Statement.
- , 186
- Soldier's Record of Death and Interment.
- , 186
- Soldier's Inventory of Effects.
- , 186
- Soldier's Certificate of Disability for Discharge.
- , 186
- Soldier's Individual Muster-out Roll.
- , 186 .
- Regimental Return.
- For , 186 , , 186 .
- Regimental Quarterly Returns.
- , 186
- Regimental Descriptive Book.
- , 186
- By Surgeon General.

() , 186 , is held to be
the correct date, and the Company Muster
Roll will be amended accordingly.

C.B. "
30.
Asst. Adj. Gen.

Noted on Register

1522

Wright, Isham

Co A, 1 U. S. Col'd Cav.

Private Private

CARD NUMBERS.

1	5305248	26
2	5305317	27
3	5305390	28
4	5305467	29
5	5305543	30
6	5305619	31
7	5305723	32
8	5305813	33
9	5305933	34
10	5306048	35
11	5306151	36
12	5306248	37
13	5306349	38
14	5306442	39
15	5306532	40
16	9086101	41
17		42
18		43
19		44
20		45
21		46
22		47
23		48
24		49
25		50

Book Mark:

See also

N. | **1 Cav. | U.S.C.T.**

Johnan Wright

, Co. *D.*, 1 Reg't U.S. Col'd Cav.

Appears on

Company Descriptive Book

of the organization named above.

DESCRIPTION.

Age *20* years; height *5* feet *8* inches.

Complexion *Dark.*

Eyes; *Dark.* hair *Dark.*

Where born *Norfolk Co. Va*

Occupation *Laborer.*

ENLISTMENT.

When *Dec 5/63.*

Where *Norfolk Va.*

By whom *Capt Brown*; term *3* y'rs.

Remarks:-----

Dickerson.

W | 1 Cav. | U.S.C.T.

Isaac Wright

Pvt., Co. G, 1 Reg't U. S. Col'd Cavalry.

Age 22 years.

Appears on

Company Muster-in Roll

of the organization named above. Roll dated

Camp Newmillen Va Dec 22, 1863.

Muster-in to date Dec 22, 1863.

Joined for duty and enrolled:

When Dec 5, 1863.

Where Norfolk Va

Period 3 years.

Valuation of horse, \$ 100

Valuation of horse equipments, \$ 100

Remarks:

Book mark:

E. B. Thompson

(356)

Copyist.

W | **1 Cav.** | **U.S.C.T.**

Isaac Wright

Pvt, Co. D, 1 Reg't U. S. Col'd Cavalry.

Appears on

Company Muster Roll

for *from Dec 22 to Dec 31*, 1863.

Present or absent *Present*

Stoppage, \$ *100* for

Due Gov't, \$ *100* for

Valuation of horse, \$ *100*

Valuation of horse equipments, \$ *100*

Remarks:

Book mark:

E. B. Thompson

(358)

Copyist.

W | **1 Cav.** | **U.S.C.T.**

Osham Wright

PM, Co. D, 1 Reg't U. S. Col'd Cavalry.

Appears on

Company Muster Roll

for *Jan & Feb.*, 186*1*.

Present or absent *Present*

Stoppage, \$ *100* for

Due Gov't, \$ *100* for

Valuation of horse, \$ *100*

Valuation of horse equipments, \$ *100*

Remarks:

.....
.....
.....
.....
.....
.....
.....
.....
.....

Book mark:

E. B. Thompson

(358)

Copyist.

W | 1 Cav. | U.S.C.T.

Sham Wright

Pvt, Co. D, 1 Reg't U. S. Cav'd Cavalry.

Appears on

Company Muster Roll

for *Mch & Apr*, 186*1*.

Present or absent *Present*

Stoppage, \$ *100* for

Due Gov't, \$ *100* for

Valuation of horse, \$ *100*

Valuation of horse equipments, \$ *100*

Remarks:

Book mark:

E. B. Thompson

(358)

Copyist.

W | 1 Cav. | U.S.C.T.

Isham Wright

Plt, Co. D, 1 Reg't U.S. Col'd Cavalry.

Appears on

Company Muster Roll

for May & June, 1864.

Present or absent Absent

Stoppage, \$ 100 for

Due Gov't, \$ 100 for

Valuation of horse, \$ 100

Valuation of horse equipments, \$ 100

Remarks: Ab. on detach. duty since
June 26. In Sp. orders dated
Nov 2nd 1864 U.S. Col'd Cavalry.

Book mark:

E. B. Thompson

(358)

Copyist.

N | **1 Cav.** | **U.S.C.T.**

Stephen Wright

RA, Co. D, 1 Reg't U. S. Col'd Cavalry.

Appears on

Company Muster Roll

for July - Aug., 1861.

Present or absent Present

Stoppage, \$ 100 for

Due Gov't, \$ 100 for

Valuation of horse, \$ 100

Valuation of horse equipments, \$ 100

Remarks:

Book mark:

E. B. Thompson

(358)

Copyist.

7/1

1 Cav. U.S.C.T.

James H. Hight
1st Lt, Co. D, 1 Reg't U. S. Col'd Cavalry.

Appears on

Company Muster Roll

for *1st Reg't*, 186*4*.

Present or absent *Present*

Stoppage, \$ *100* for

Due Gov't, \$ *100* for

Valuation of horse, \$ *100*

Valuation of horse equipments, \$ *100*

Remarks:

Book mark: -----

(358)

James H. Hight

Copyist.

H | 1 Cav. | U.S.C.T.

Sham Wright
1st, Co. D, 1 Reg't U. S. Col'd Cavalry.

Appears on

Company Muster Roll

for *Nov Dec*, 1864.

Present or absent *Present*

Stoppage, \$ 100 for

Due Gov't, \$ 100 for

Valuation of horse, \$ 100

Valuation of horse equipments, \$ 100

Remarks:

Book mark: -----

(358)

Lebens

Copyist.

77

1 Cav. U.S.C.T.

Isaac Knight

Co. D, 1 Reg't U. S. Col'd Cavalry.

Appears on

Company Muster Roll

for June 1865, 1865.

Present or absent Present

Stoppage, \$ 100 for

Due Gov't, \$ 100 for

Valuation of horse, \$ 100

Valuation of horse equipments, \$ 100

Remarks:

Book mark:

Copyist

H | 1 Cav. | U.S.C.T.

Sham Bright

Co. D, Co. D, 1 Reg't U. S. Col'd Cavalry.

Appears on

Company Muster Roll

for *May & June*, 186*7*.

Present or absent *Present*

Stoppage, \$ *100* for

Due Gov't, \$ *100* for

Valuation of horse, \$ *100*

Valuation of horse equipments, \$ *100*

Remarks:

Book mark: -----

(358)

Sham Bright

Copyist.

A | 1 Cav. | U.S.C.T.

Simon Wright
1st, Co. D, 1 Reg't U. S. Col'd Cavalry.

Appears on

Company Muster Roll

for *May & June*, 186*5*.

Present or absent *Present*

Stoppage, \$ *100* for

Due Gov't, \$ *100* for

Valuation of horse, \$ *100*

Valuation of horse equipments, \$ *100*

Remarks:

Book mark: -----

Wright

(358) Copyist.

H | 1 Cav. | U.S.C.T.

Isaac Wright

Pos, Co. D, 1 Reg't U. S. Col'd Cavalry.

Appears on

Company Muster Roll

for July & Aug, 1865.

Present or absent Present

Stoppage, \$ 100 for

Due Gov't, \$ 100 for

Valuation of horse, \$ 100

Valuation of horse equipments, \$ 100

Remarks:

Book mark: -----

W. B. Jones
(358) Copyist.

W | 1 Cav. | U.S.C.T.

John Wright

Priv, Co. D, 1 Reg't U. S. Col'd Cavalry.

Appears on

Company Muster Roll

for *Sept. & Oct.*, 186*5*.

Present or absent *Present*

Stoppage, \$ *100* for

Due Gov't, \$ *100* for

Valuation of horse, \$ *100*

Valuation of horse equipments, \$ *100*

Remarks:

Book mark:

H. E. Wilson

(358)

Copyist.

H | 1 Cav. | U.S.C.T.

Isaac Wright

Priv., Co. D, 1 Reg't U. S. Col'd Cavalry.

Appears on

Company Muster Roll

for *Nov. & Dec.*, 186*5*.

Present or absent *present*

Stoppage, \$ *100* for

Due Gov't, \$ *100* for

Valuation of horse, \$ *100*

Valuation of horse equipments, \$ *100*

Remarks:

Book mark:

R. E. Wilson

(358)

Copyist.

H | **1 Cav.** | **U.S.C.T.**

Isaac Wright

Priv., Co. *D*, 1 Reg't U. S. Col'd Cavalry.

Appears on **Co. Muster-out Roll**, dated *Arroyo Santiago Tex.*, *Feb. 14*, 186*4*.

Muster-out to date *Feb. 14*, 186*6*.

Last paid to *Aug. 21*, 186*5*.

Clothing account:

Last settled....., 186 ; drawn since \$.....100

Due soldier \$.....100; due U. S. \$.....*8*^{*117*}/_{*100*}

Am't for cloth'g in kind or money adv'd \$.....100

Due U. S. for arms, equipments, &c., \$.....100

Bounty paid \$.....100; due \$.....100

Remarks: *Joined at orig. org.*

Book mark :

R. E. Wilson

(361)

Copyist.

1523

Wright John

Co *A*, 1 U. S. Col'd Cav.

Private Private

CARD NUMBERS.

1	5305250	26
2	5305319	27
3	5305392	28
4	5305468	29
5	5305544	30
6	5305620	31
7	5305724	32
8	5305814	33
9	5305934	34
10	5306049	35
11	5306152	36
12	5306249	37
13	5306348	38
14	5306443	39
15	5306533	40
16	9086103	41
17	40725524	42
18		43
19		44
20		45
21		46
22		47
23		48
24		49
25		50

Book Mark: V. 114. P. 185-70

See also

S. 676508 P. 6. aff

D. 679762 P. 90

D. 2174448 P. 0. m m

M. D. 1012546

Howard
Ex

W. | 1 Cav. | U.S.C.T.

John Wright.

....., Co. *D.*, 1 Reg't U.S. Col'd Cav.

Appears on

Company Descriptive Book

of the organization named above.

DESCRIPTION.

Age *18* years; height *5* feet *8* inches.

Complexion *Dark.*

Eyes; *Dark,* hair *Dark.*

Where born *Norfolk Co., Va.*

Occupation *Laborer.*

ENLISTMENT.

When *Dec. 10/63*

Where *Norfolk.*

By whom *Capt Brown*; term *3* y'rs.

Remarks:.....

.....

Dickerson.

W. | 1 Cav. | U.S.C.T.

John Wright.

....., Co. *D.*, 1 Reg't U.S. Col'd Cav.

Appears on

Company Descriptive Book

of the organization named above.

DESCRIPTION.

Age *18* years ; height *5* feet *8* inches.

Complexion *Dark.*

Eyes; *Dark.* hair *Dark.*

Where born *Norfolk Co., Va.*

Occupation *Laborer.*

ENLISTMENT.

When *Dec. 10/63*

Where *Norfolk.*

By whom *Capt Brown* ; term *3* y'rs.

Remarks:

.....

.....

.....

.....

.....

.....

.....

.....

.....

Dickerson.

W | **1 Cav.** | **U.S.C.T.**

John Wright
Pt. Co. *10*, 1 Reg't U. S. Col'd Cavalry.
Age *19* years.

Appears on

Company Muster-in Roll

of the organization named above. Roll dated
Camp Hamilton Va Dec 22, 1863.
Muster-in to date *Dec 22*, 1863.

Joined for duty and enrolled:

When *Dec 10*, 1863.
Where *Norfolk Va.*
Period *3* years.

Valuation of horse, \$ *100*

Valuation of horse equipments, \$ *100*

Remarks:
.....
.....
.....
.....

Book mark:

E. B. Thompson

(356)

Copyist.

W | 1 Cav. | U.S.C.T.

John Wright
Pvt., Co. D, 1 Reg't U. S. Col'd Cavalry.

Appears on

Company Muster Roll

for from Dec 29 to Dec 31, 1863.

Present or absent Present

Stoppage, \$ 100 for

Due Gov't, \$ 100 for

Valuation of horse, \$ 100

Valuation of horse equipments, \$ 100

Remarks:

Book mark:

E. B. Thompson

(358)

Copyist.

W | **1 Cav.** | **U.S.C.T.**

John Wright
Pvt, Co. D, 1 Reg't U. S. Col'd Cavalry.

Appears on

Company Muster Roll

for *Jan & Feb.*, 186*4*.

Present or absent *Present*

Stoppage, \$ *100* for

Due Gov't, \$ *100* for

Valuation of horse, \$ *100*

Valuation of horse equipments, \$ *100*

Remarks:

Book mark:

E. B. Thompson
Copyist.

(358)

W | 1 Cav. | U.S.C.T.

John Wright
Pvt, Co. D, 1 Reg't U. S. Col'd Cavalry.

Appears on

Company Muster Roll

for *Mch & Apr*, 1864.

Present or absent *Present*

Stoppage, \$ *100* for

Due Gov't, \$ *100* for

Valuation of horse, \$ *100*

Valuation of horse equipments, \$ *100*

Remarks:

Book mark:

E. B. Thompson

(358)

Copyist.

W | 1 Cav. | U.S.C.T.

John Wright
Plt, Co. D, 1 Reg't U. S. Col'd Cavalry.

Appears on

Company Muster Roll

for *May & June*, 1864.

Present or absent *Present*

Stoppage, \$ 100 for

Due Gov't, \$ 100 for

Valuation of horse, \$ 100

Valuation of horse equipments, \$ 100

Remarks:

Book mark:

E. B. Thompson

(358)

Copyist.

W | 1 Cav. | U.S.C.T.

John Wright

Plt, Co. D, 1 Reg't U. S. Col'd Cavalry.

Appears on

Company Muster Roll

for *July & Aug.*, 186*1*/₂.

Present or absent *Present*

Stoppage, \$ *100* for

Due Gov't, \$ *100* for

Valuation of horse, \$ *100*

Valuation of horse equipments, \$ *100*

Remarks:

Book mark: _____

E. B. Thompson

(358)

Copyist.

A | 1 Cav. | U.S.C.T.

John Bright

W, Co. D, 1 Reg't U. S. Col'd Cavalry.

Appears on

Company Muster Roll

for *Sept 1861*, 1861.

Present or absent *Present*

Stoppage, \$ *100* for

Due Gov't, \$ *100* for

Valuation of horse, \$ *100*

Valuation of horse equipments, \$ *100*

Remarks:

Book mark: -----

W

(358) Copyist.

74 | 1 Cav. | U.S.C.T.

John Knight

Co. D, 1 Reg't U. S. Col'd Cavalry.

Appears on

Company Muster Roll

for Nov 1864, 1864.

Present or absent Present

Stoppage, \$ 100 for

Due Gov't, \$ 100 for

Valuation of horse, \$ 100

Valuation of horse equipments, \$ 100

Remarks:

Book mark:

W. H. ...

1/1 | **1 Cav.** | **U.S.C.T.**

William Knight

Pay, Co. D, 1 Reg't U. S. Col'd Cavalry.

Appears on

Company Muster Roll

for *Jany & Feb'y*, 186*7*.

Present or absent *Present*

Stoppage, \$ *100* for

Due Gov't, \$ *100* for

Valuation of horse, \$ *100*

Valuation of horse equipments, \$ *100*

Remarks:

Book mark:

(358)

Abner

Copyist.

H | **1 Cav.** | **U.S.C.T.**

John Bright

Sgt, Co. D, 1 Reg't U. S. Col'd Cavalry.

Appears on

Company Muster Roll

for *May 1865*, 1865.

Present or absent *Present*

Stoppage, \$ *100* for

Due Gov't, \$ *100* for

Valuation of horse, \$ *100*

Valuation of horse equipments, \$ *100*

Remarks:

Book mark: _____

(358)

Alvins
Pr. Corp

Copyist.

H

1 Cav. U.S.C.T.

John Bright

Pos, Co. D, 1 Reg't U. S. Col'd Cavalry.

Appears on

Company Muster Roll

for *May June*, 1865.

Present or absent *Present*

Stoppage, \$ 100 for

Due Gov't, \$ 100 for

Valuation of horse, \$ 100

Valuation of horse equipments, \$ 100

Remarks:

Book mark:

W. H. ...

(358)

Copyist.



H | 1 Cav. | U.S.C.T.

John Wright

Asst, Co. D, 1 Reg't U. S. Col'd Cavalry.

Appears on

Company Muster Roll

for *May Day*, 186*5*.

Present or absent *Present*

Stoppage, \$ *100* for

Due Gov't, \$ *100* for

Valuation of horse, \$ *100*

Valuation of horse equipments, \$ *100*

Remarks:

Book mark:

(358)

W. Brown

Copyist.

H

1 Cav.

U.S.C.T.

John Haight

Priv.

, Co. D, 1 Reg't U. S. Col'd Cavalry.

Appears on

Company Muster Roll

for

Sept. & Octo., 186*5*.

Present or absent

present

Stoppage, \$

100 for

Due Gov't, \$

100 for

Valuation of horse, \$

100

Valuation of horse equipments, \$

100

Remarks:

Book mark:

R. E. Wilson

(358)

Copyist.

H | 1 Cav. | U.S.C.T.

John Wright

Priv., Co. D, 1 Reg't U. S. Col'd Cavalry.

Appears on

Company Muster Roll

for *Nov. & Dec.*, 186*5*.

Present or absent *present*

Stoppage, \$ *100* for

Due Gov't, \$ *100* for

Valuation of horse, \$ *100*

Valuation of horse equipments, \$ *100*

Remarks:
.....
.....
.....
.....
.....
.....
.....
.....

Book mark:

R. E. Wilson

(358)

Copyist.

W | 1 Cav. | U.S.C.T.

John Wright
Priv., Co. *B*, 1 Reg't U. S. Colored Cav.

Appears on Returns as follows:

Aug to Dec 1865 on duty
duty in Fishing detail

Book mark :

John Wright

(546)

Copyist.

W | **1 Cav.** | **U.S.C.T.**

John Wright

Priv., Co. *D*, 1 Reg't U. S. Col'd Cavalry.

Appears on **Co. Muster-out Roll**, dated *Brazos Santiago, Tex., Feb. 14, 1866.*

Muster-out to date *Feb. 14, 1866.*

Last paid to *Aug 31, 1865.*

Clothing account:

Last settled....., 186 ; drawn since \$.....100

Due soldier \$.....⁹⁶/₁₀₀; due U. S. \$.....100

Am't for cloth'g in kind or money adv'd \$.....100

Due U. S. for arms, equipments, &c., \$.....100

Bounty paid \$.....100; due \$.....100

Remarks: *Joined at orig. org.*

Book mark: *V114 P185 '70*

R. E. Wilson

(361)

Copyist.

Wright Moser

Co A, 1 U. S. Col'd Cav.

Private Corporal

CARD NUMBERS.

1	5310728	26
2	5310797	27
3	5310869	28
4	5310940	29
5	5311013	30
6	5300269	31
7	5311096	32
8	5311187	33
9	5311291	34
10	5311396	35
11	5311433	36
12	5311536	37
13	5311640	38
14	5311740	39
15	5311841	40
16	5311940	41
* 17	9086567	42
* 18	9086570	43
19	9086571	44
20		45
21		46
22		47
23		48
24		49
25		50

Card withdrawn and filed in jacket No. 1525, where it properly belongs.

May 28, 1903, JAV

Book Mark: P.M. 4.1.762 June 28/66.

V40 P 198/69

See also

M. V. Carr | U.S.C.T.

Moses Wright

Privt, Co *H*, *1* Reg't U. S. Col'd *Carr*

Appears on

Company Descriptive Book

of the organization named above.

DESCRIPTION.

Age *19* years; height *5* feet *7* inches.

Complexion *Black.*

Eyes *Black*; hair *Black.*

Where born *Suffolk V.*

Occupation

ENLISTMENT.

When *Dec 12*, 186*3*.

Where *Weymouth.*

By whom *Capt Brown*; term *3* y'rs.

Remarks:

.....
.....
.....
.....
.....
.....
.....
.....
.....
.....

Dickerson.

67 | **1 Cav. | U.S.C.T.**

James Knight

Co. 7, 1 Reg't U. S. Col'd Cavalry.

Age 17 years.

Appears on

Company Muster-in Roll

of the organization named above. Roll dated

September 14, 1864, 1864.

Muster-in to date October 1, 1865.

Joined for duty and enrolled:

When Dec 1864, 1864.

Where Franklin Co.

Period 1 years.

Valuation of horse, \$ 100

Valuation of horse equipments, \$ 100

Remarks: _____

Book mark: _____

(356)

James Knight
Copyist.

71

1 Cav. U.S.C.T.

James H. ...

..., Co. H, 1 Reg't U. S. Col'd Cavalry.

Appears on

Company Muster Roll

for *...*, 186 .

Present or absent *...*

Stoppage, \$ 100 for

Due Gov't, \$ 100 for

Valuation of horse, \$ 100

Valuation of horse equipments, \$ 100

Remarks:

Book mark:

(358)

Chas. ...

Copyist.

01 | **1 Cav.** | **U.S.C.T.**

Moses Wright

Priv, Co. H, 1 Reg't U. S. Col'd Cavalry.

Appears on

Company Muster Roll

for *Jan & Feb*, 1864.

Present or absent *Present*

Stoppage, \$ *100* for

Due Gov't, \$ *100* for

Valuation of horse, \$ *100*

Valuation of horse equipments, \$ *100*

Remarks:

Book mark:

(358)

A. E. Edwards
Copyist.

1 Cav. U.S.C.T.

James H. ...

James H. ..., Co. H, 1 Reg't U. S. Col'd Cavalry.

Appears on

Company Muster Roll

for *James H. ...*, 1864.

Present or absent *Present*

Stoppage, \$ *100* for

Due Gov't, \$ *100* for

Valuation of horse, \$ *100*

Valuation of horse equipments, \$ *100*

Remarks:

Book mark:

(358)

James H. ...
Copyist.

U.S.C.T.

James H. ...
... Co. ... / Reg't U. S. Col'd ...

Appears on

Company Muster Roll

for *...*, 186*...*

Present or absent *...*

Stoppage, \$ *...* 100 for *...*

Due Gov't, \$ *...* 100 for *...*

Valuation of horse, \$ *...* 100

Valuation of horse equipments, \$ *...* 100

Remarks: *...*

...
...
...
...
...

Book mark: *...*

(358)

...

Copyist.

Or 1 | 1 Cav. | U.S.C.T.

Moses Abright

, Co., | Reg't U. S. Col'd Cavalry

Appears on a

Detachment Muster Roll

of the organization named above

for May & June, 1864.

Station In the field Va near Petersburg

Present or absent Present

Stoppage, \$ 100 for

Due Gov't, \$ 100 for

Valuation of horse, \$ 100

Valuation of horse equipments, \$ 100

Remarks :

Book mark :

Hammer

(344)

Copyist.

1 Cav. U.S.C.T.

..., Co. H, 1 Reg't U. S. Col'd Cavalry.

Appears on

Company Muster Roll

for ..., 186...

Present or absent

Stoppage, \$ 100 for

Due Gov't, \$ 100 for

Valuation of horse, \$ 100

Valuation of horse equipments, \$ 100

Remarks:

Book mark:

(358)

Copyist.

A

1 Cav. U.S.C.T.

Moses Wright

Priv, Co. H, 1 Reg't U. S. Col'd Cavalry.

Appears on

Company Muster Roll

for *Sept - Oct*, 186*4*.

Present or absent *Present*

Stoppage, \$ *100* for

Due Gov't, \$ *100* for

Valuation of horse, \$ *100*

Valuation of horse equipments, \$ *100*

Remarks:

Book mark:

M Jackson

(358)

Copyist.

Of

1 Cav. | U.S.C.T.

Moses Wright

Priv, Co. H, 1 Reg't U. S. Col'd Cavalry.

Appears on

Company Muster Roll

for *Nov & Dec*, 186*4*

Present or absent *Present*

Stoppage, \$ *100* for

Due Gov't, \$ *100* for

Valuation of horse, \$ *100*

Valuation of horse equipments, \$ *100*

Remarks:

Book mark:

(358)

O M Jackson
Copyist.

H | **1 Cav.** | **U.S.C.T.**

Moses Bright

Prof, Co. H, 1 Reg't U. S. Col'd Cavalry.

Appears on

Company Muster Roll

for *Jan & Feb*, 1865.

Present or absent *Present*

Stoppage, \$ *100* for

Due Gov't, \$ *100* for

Valuation of horse, \$ *100*

Valuation of horse equipments, \$ *100*

Remarks:

Book mark:

(358)

J. Jackson

Copyist.

27 | 1 Cav. | U.S.C.T.

Moses Wright

Carp, Co. H, 1 Reg't U. S. Col'd Cavalry.

Appears on

Company Muster Roll

for *Mea + Apl*, 1865.

Present or absent *Present*

Stoppage, \$ *100* for

Due Gov't, \$ *100* for

Valuation of horse, \$ *100*

Valuation of horse equipments, \$ *100*

Remarks: *Apptd Carp
Mea 5/65 per S.O. No. 1
Ad 2rs Detachment 1st U.S.C.*

Book mark:

(358)

M Jackson

Copyist.

21 | **1 Cav.** | **U.S.C.T.**

Moses Bright

Carp, Co. H, 1 Reg't U. S. Col'd Cavalry.

Appears on

Company Muster Roll

for *May June*, 1865.

Present or absent *Present*

Stoppage, \$ *100* for

Due Gov't, \$ *100* for

Valuation of horse, \$ *100*

Valuation of horse equipments, \$ *100*

Remarks:

.....
.....
.....
.....
.....
.....
.....
.....
.....

Book mark:

M. J. Green
Copyist.

H | 1 Cav. | U.S.C.T.

Moses Wright

Capt, Co. H, 1 Reg't U. S. Col'd Cavalry.

Appears on

Company Muster Roll

for *July - Aug*, 186*0*.

Present or absent *Present*

Stoppage, \$ *100* for

Due Gov't, \$ *100* for

Valuation of horse, \$ *100*

Valuation of horse equipments, \$ *100*

Remarks:

Book mark: *100*

(358)

M Jackson
Copyist.

W | 1 Cav. | U.S.C.T.

Moses Wright
Capt, Co. H, 1 Reg't U. S. Col'd Cavalry.

Appears on

Company Muster Roll

for Sept 30 et, 1865.

Present or absent Present

Stoppage, \$ 100 for

Due Gov't, \$ 100 for

Valuation of horse, \$ 100

Valuation of horse equipments, \$ 100

Remarks:

Book mark:

J. Stewart
Copyist.

W | 1 Cav. | U.S.C.T.

Moses Wright
Corpl, Co. H, 1 Reg't U.S. Col'd Cavalry.

Appears on

Company Muster Roll

for Nov & Dec, 1863.

Present or absent Present

Stoppage, \$ 100 for

Due Gov't, \$ 100 for

Valuation of horse, \$ 100

Valuation of horse equipments, \$ 100

Remarks:

Book mark:

JH Stewart

(358)

Copyist.

CV | 1 Cav. | U.S.C.T.

Moses Wright

Cop, Co. A, 1 Reg't U. S. Col'd Cavalry.

Appears on Co. Muster-out Roll, dated
Brazos Santiago Tex, Feb 4, 1866.
Muster-out to date Feb 4, 1866.
Last paid to Aug 31, 1865.

Clothing account:

Last settled _____, 186 ; drawn since \$ 100
Due soldier \$ 100; due U. S. \$ 24 ⁶⁶/₁₀₀
Am't for cloth'g in kind or money adv'd \$ 100

Due U. S. for arms, equipments, &c., \$ 100

Bounty paid \$ 100; due \$ 100

Remarks: Joined at Big Big Pt until Mar 16/66

Book mark: P.M.G. 1762 Jan 28/66 (over)

W Stewart

NRRA 664

JAN. - 6

5311940

1891 *

v40 P198/69

1525

Wright Moser

Co *A*, 1 U. S. Col'd Cav.

Corporal Sergeant

CARD NUMBERS.

1	5310678	26
2	5310747	27
3	5310816	28
4	5310887	29
5	5310960	30
6	5300291	31
7	5311035	32
8	5311124	33
9	5311214	34
10	5311318	35
11	5311423	36
12	5311527	37
13	5311631	38
14	5311731	39
15	5311832	40
16	5311932	41
17	9086571	42
18	9086567	43
19	9086510	44
20	40725522	45
21		46
22		47
23		48
24		49
25		50

Card withdrawn and filed in jacket No. 1524 where it properly belongs. May 28/03. JH.V.

Book Mark: V 40 P. 198/69

See also

W. | *1 Cav.* | **U.S.C.T.**

Moses Wright.

Capt., Co. *A*, *1* Reg't U. S. Col'd *Cav.*

Appears on

Company Descriptive Book

of the organization named above.

DESCRIPTION.

Age *19* years; height *5* feet *3* inches.

Complexion *Yellow*

Eyes *Blue*; hair *Black* ~~*Blue*~~ #

Where born *Norfolk V.*

Occupation

ENLISTMENT.

When *Dec 12*, 186*3*.

Where *Norfolk.*

By whom *Capt Brown*; term *3* y'rs.

Remarks:

** Corrected by J.H. June 17, 1903.*

Dickerson.

W. | Lear | U.S.C.T.

Moses Wright,

, Co. A, 1 Reg't U. S. Col'd Cav.

Appears on

Company Descriptive Book

of the organization named above.

DESCRIPTION.

Age *21* years; height *5* feet *2* inches.

Complexion *Light*

Eyes *Gray*; hair *Black*.

Where born *Portsmouth Va.*

Occupation *Baker.*

ENLISTMENT.

When *Dec 12*, 18*63*.

Where *Norfolk Va.*

By whom *Capt Brown*; term *3* y'rs.

Remarks:

Dickerson.

11 | **1 Cav.** | **U.S.C.T.**

James Wright

Co. G, 1 Reg't U. S. Col'd Cavalry.

Age 17 years.

Appears on

Company Muster-in Roll

of the organization named above. Roll dated

Hamilton Va, Dec 2, 1863.

Muster-in to date Dec 2, 1863.

Joined for duty and enrolled:

When Dec 2, 1863.

Where Hamilton Va

Period 0 years.

Valuation of horse, \$ 100

Valuation of horse equipments, \$ 100

Remarks: _____

Book mark: _____

1 Cav. U.S.C.T.

James H. Smith
Smith, Co. H, 1 Reg't U. S. Col'd Cavalry.

Appears on

Company Muster Roll

for *Dec 31*, 186*5*.

Present or absent *Present*

Stoppage, \$ *100* for

Due Gov't, \$ *100* for

Valuation of horse, \$ *100*

Valuation of horse equipments, \$ *100*

Remarks:

Present on muster
at this time

Book mark:

(358)

James H. Smith
Copyist.

C | 1 Cav. | U.S.C.T.

Wm. L. ...

..., Co. H, 1 Reg't U. S. Col'd Cavalry.

Appears on

Company Muster Roll

for *...*, 186*...*

Present or absent *Present*

Stoppage, \$ *100* for

Due Gov't, \$ *100* for

Valuation of horse, \$ *100*

Valuation of horse equipments, \$ *100*

Remarks:
.....
.....
.....
.....
.....
.....

Book mark:

(358)

Wm. L. ...

Copyist.

W

1 Cav. U.S.C.T.

John Smith

Boyle, Co. H, 1 Reg't U. S. Col'd Cavalry.

Appears on

Company Muster Roll

for *John Smith*, 1864.

Present or absent *Present*

Stoppage, \$ 100 for

Due Gov't, \$ 100 for

Valuation of horse, \$ 100

Valuation of horse equipments, \$ 100

Remarks:

Book mark: -----

(358)

John Smith

Copyist.

21 | 1 Cav. | U.S.C.T.

James Wright

Wright, Co. H, 1 Reg't U. S. Col'd Cavalry.

Appears on

Company Muster Roll

for *March 1864*, 1864.

Present or absent *Absent*

Stoppage, \$ *100* for

Due Gov't, \$ *100* for

Valuation of horse, \$ *100*

Valuation of horse equipments, \$ *100*

Remarks:

Wright was absent from duty during the month of March 1864.

Book mark:

(358)

James Wright
Copyist.

W 1 1 car. U.S.C.T.

Moses Wright
 Corp, Co. 1 Reg't U. S. Col'd Cavalry
 Appears on a

Detachment Muster Roll

of the organization named above

for May & June, 1864

Station Battlefield Hosp^l near Petersburg Va

Present or absent Present

Stoppage, \$ 100 for

Due Gov't, \$ 100 for

Valuation of horse, \$ 100

Valuation of horse equipments, \$ 100

Remarks :

Book mark :

(344)

Hammer

Copyist.

17

1 Cav. U.S.C.T.

Wm. E. Edwards

Wm. E. Edwards, Co. H, 1 Reg't U. S. Col'd Cavalry.

Appears on

Company Muster Roll

for *Wm. E. Edwards*, 186*4*.

Present or absent *Present*

Stoppage, \$ *100* for

Due Gov't, \$ *100* for

Valuation of horse, \$ *100*

Valuation of horse equipments, \$ *100*

Remarks:

Book mark: -----

Wm. E. Edwards

(358)

Copyist.

A | 1 Cav. | U.S.C.T.

Moses Wright

Capt, Co. H, 1 Reg't U. S. Col'd Cavalry.

Appears on

Company Muster Roll

for *Sept 30*, 186*4*.

Present or absent *Present*

Stoppage, \$ *100* for

Due Gov't, \$ *100* for

Valuation of horse, \$ *100*

Valuation of horse equipments, \$ *100*

Remarks:

Book mark:

(358)

J Jackson
Copyist.

24

1 Cav. U.S.C.T.

Moses Bright

Carp, Co. H, 1 Reg't U. S. Col'd Cavalry.

Appears on

Company Muster Roll

for *Nov & Dec*, 186*4*

Present or absent *Present*

Stoppage, \$ *100* for

Due Gov't, \$ *100* for

Valuation of horse, \$ *100*

Valuation of horse equipments, \$ *100*

Remarks:

Book mark: _____

(358)

J M Jackson
Copyist.

A | 1 Cav. | U.S.C.T.

Moses Wright

Sgt, Co. H, 1 Reg't U. S. Col'd Cavalry.

Appears on

Company Muster Roll

for *Jan & Feb*, 186*5*

Present or absent *Present*

Stoppage, \$ *100* for

Due Gov't, \$ *100* for

Valuation of horse, \$ *100*

Valuation of horse equipments, \$ *100*

Remarks *Appointed Sargent*
Jan'y 1st 1865

Book mark:

(358)

W. Jackson
Copyist.

H | 1 Cav. | U.S.C.T.

Moses Knight

Sgt, Co. H, 1 Reg't U. S. Col'd Cavalry.

Appears on

Company Muster Roll

for *McK + Apl*, 1865.

Present or absent *Present*

Stoppage, \$ *100* for

Due Gov't, \$ *100* for

Valuation of horse, \$ *100*

Valuation of horse equipments, \$ *100*

Remarks:

Book mark: -----

(358)

A. M. Jackson
Copyist.

A | 1 Cav. | U.S.C.T.

Moses Wright

Sgt, Co. H, 1 Reg't U. S. Col'd Cavalry.

Appears on

Company Muster Roll

for *May June*, 1865.

Present or absent *Present*

Stoppage, \$ *100* for

Due Gov't, \$ *100* for

Valuation of horse, \$ *100*

Valuation of horse equipments, \$ *100*

Remarks:
.....
.....
.....
.....
.....
.....
.....
.....

Book mark:

(358)

M. Jackson
Copyist.

21 | **1 Cav.** | **U.S.C.T.**

Moses Wright

Sgt, Co. H, 1 Reg't U. S. Col'd Cavalry.

Appears on

Company Muster Roll

for July & Aug, 1865.

Present or absent Present

Stoppage, \$ 100 for

Due Gov't, \$ 100 for

Valuation of horse, \$ 100

Valuation of horse equipments, \$ 100

Remarks:

Book mark: Sept. 1865

(358)

M Jackson

Copyist.

W | 1 Cav. | U.S.C.T.

Moses Wright
Sergt, Co. H, 1 Reg't U. S. Col'd Cavalry.

Appears on

Company Muster Roll

for Sept & Oct, 1865.

Present or absent Present

Stoppage, \$ 100 for

Due Gov't, \$ 100 for

Valuation of horse, \$ 100

Valuation of horse equipments, \$ 100

Remarks:

Book mark:

(358)

J. H. Stewart

Copyist.

W | 1 Cav. | U.S.C.T.

Moses Wright

Serjt, Co. H, 1 Reg't U. S. Col'd Cavalry.

Appears on

Company Muster Roll

for Jan & Dec, 1865.

Present or absent Present

Stoppage, \$ 100 for

Due Gov't, \$ 100 for

Valuation of horse, \$ 100

Valuation of horse equipments, \$ 100

Remarks:

[Empty lines for remarks]

Book mark:

J. H. Stewart

(358)

Copyist.

W | 1 Cav. | U.S.C.T.

Moses Wright

Serj't, Co. K, 1 Reg't U. S. Col'd Cavalry.

Appears on Co. Muster-out Roll, dated
Brazos Santiago Tex, Feb 4, 1866.

Muster-out to date Feb 4, 1866.

Last paid to Aug 31, 1865.

Clothing account:

Last settled _____, 186 ; drawn since \$ _____ 100

Due soldier \$ _____ / ⁴⁶ / 100; due U. S. \$ _____ 100

Am't for cloth'g in kind or money adv'd \$ _____ 100

Due U. S. for arms, equipments, &c., \$ _____ 100

Bounty paid \$ _____ 100; due \$ _____ 100

Remarks: Joined at Org Org

Private until Dec 15/63

Corpl until Jan 1/65

Book mark 40 P 198769

J. H. Stewart

(361)

Copyist.

W | 1 Cav. | U.S.C.T.

+ Moses Wright
Capt., Co. H; 1 Reg't U. S. Colored Cav.

Appears on Returns as follows:

July 1864 absent
detached service June 24th 64
Ambulance Corps

Sept 18 64 on duty Provost
Corps

+ From no. Roll

Book mark:

Chas. Patton

1525
Wright, Raphael

Co K, 1 U. S. Col'd Cav.
 Personal papers herein

Receiver

Private

CARD NUMBERS.

1	5299836	26
2	5311293	27
3	5311411	28
4	5311503	29
5	5311604	30
6	5311708	31
7	5311808	32
8	5311907	33
9	5312027	34
10	9086619	35
11	30852881	36
12	30854613	37
13	40725525	38
14		39
15		40
16		41
17		42
18		43
19		44
20		45
21		46
22		47
23		48
24		49
25		50

Book Mark: _____

See also _____

W. | 1 Cav. | U.S.C.T.

Raphael Wright

, Co. H, 1 Reg't U. S. Col'd Cav.

Appears on

Company Descriptive Book

of the organization named above.

DESCRIPTION.

Age 18 years; height 5 feet 8 inches.

Complexion Black.

Eyes Black.; hair Black

Where born Norfolk, Va.

Occupation Farmer.

ENLISTMENT.

When Dec 22, 1864.

Where Ft Monroe.

By whom Lt Monroe; term 3 y'rs.

Remarks: Mustered into
service Dec 24-64
at N.P. News-Va by
Maj Morris

Dickerson.

7 | 1 Cav. | U.S.C.T.

Raphael Wright

Appears with rank of *Rec't* on

Muster and Descriptive Roll of a Detachment of U. S. Vols. forwarded

for the 1 Reg't U. S. Col'd Cavalry. Roll dated

Newport News Va Dec 3, 1864.

Where born *Norfolk Va*

Age *18* y'rs; occupation *farmer*

When enlisted *Dec 22, 1864.*

Where enlisted *F F Monroe*

For what period enlisted *3* years.

Eyes *blk*; hair *blk*

Complexion *blk*; height *5* ft. *8* in.

When mustered in *Dec 24, 1864.*

Where mustered in *Newport News*

Bounty paid \$ *100* ¹⁰⁰; due \$ *100* ¹⁰⁰

Where credited *Competent at large*

Company to which assigned *unattached recruit*

Remarks : _____

Book mark : _____

W. H. Smith

H | 1 Cav. | U.S.C.T.

Raphael Bright

Priv, Co. H, 1 Reg't U. S. Col'd Cavalry.

Appears on

Company Muster Roll

for *Nov & Dec*, 186*4*

Present or absent *Present*

Stoppage, \$ *100* for

Due Gov't, \$ *100* for

Valuation of horse, \$ *100*

Valuation of horse equipments, \$ *100*

Remarks: *Not paid
since enlistment*

Book mark:

(358)

O. Jackson
Copyist.

24 | **1 Cav.** | **U.S.C.T.**

Raphael Knight

Priv....., Co. H, 1 Reg't U. S. Col'd Cavalry.

Appears on

Company Muster Roll

for *Jan & Feb*....., 186*5*.

Present or absent *Present*

Stoppage, \$.....100 for.....

Due Gov't, \$.....100 for.....

Valuation of horse, \$.....100

Valuation of horse equipments, \$.....100

Remarks: *Pay due from
Enlistment*

Book mark:.....

(358)

M Jackson

Copyist.

27 | **1 Cav.** | **U.S.C.T.**

Raphael Wright

Priv, Co. H, 1 Reg't U. S. Col'd Cavalry.

Appears on

Company Muster Roll

for Men & APL, 1865.

Present or absent Present

Stoppage, \$ 100 for

Due Gov't, \$ 100 for

Valuation of horse, \$ 100

Valuation of horse equipments, \$ 100

Remarks:

Book mark:

(358)

J M Jackson

Copyist.

A. L. Cad | **U.S.C.T.**

Capitane Flight
Co., Co. H., 1st Reg't U. S. Col'd Cav.

Appears on

Company Muster Roll

for *May June*, 1865.

Present or absent *Present*

Stoppage, \$ 100 for

Due Gov't, \$ 100 for

Valuation of horse, \$ 100

Valuation of horse equipments, \$ 100

Remarks:

.....

.....

.....

.....

.....

.....

.....

.....

.....

.....

Book mark:

.....

(358) *A. L. Jackson* Copyist.

M | 1 Cav. | U.S.C.T.

Raphael Wright

Priv, Co. H, 1 Reg't U. S. Col'd Cavalry.

Appears on

Company Muster Roll

for *July - Aug*, 186*5*.

Present or absent *Absent*

Stoppage, \$ *100* for

Due Gov't, \$ *100* for

Valuation of horse, \$ *100*

Valuation of horse equipments, \$ *100*

Remarks: *Post Hosp't*
Orzas Santiago
Texas

Book mark:

(358)

M Jackson

Copyist.

W | 1 Cav. | U.S.C.T.

Raphael Wright

Pt, Co. H, 1 Reg't U. S. Col'd Cavalry.

Appears on

Company Muster Roll

for Sept & Oct, 1865

Present or absent Absent

Stoppage, \$ 100 for

Due Gov't, \$ 100 for

Valuation of horse, \$ 100

Valuation of horse equipments, \$ 100

Remarks: New Orleans
Hosp

Book mark:

J. H. Stewart

W | 1 Cav-ASCT

Raplad Wright
Pvt, Co. H, 1 Reg. Cav

Appears on

Hospital Muster Roll

of Corps d'Afrique U. S. A. General Hospital,

at New Orleans, La.,

for *Sept & Oct*, 1865.

Attached to hospital:

When....., 186 .

How employed.....

Last paid by Maj.

to....., 186 .

Bounty paid \$ 100 due \$ 100

Present or absent *Present*

Remarks:.....

Book mark:.....

Steward
(343) Copyist.

W | 1 Cav. | U.S.C.T.

Raphael Wright
Pt, Co. H, 1 Reg't U. S. Col'd Cavalry.

Appears on

Company Muster Roll

for Nov & Dec, 1865

Present or absent Absent

Stoppage, \$ 100 for

Due Gov't, \$ 100 for

Valuation of horse, \$ 100

Valuation of horse equipments, \$ 100

Remarks: Sick in Hospital
New Orleans

Book mark:

(358) J. Stewart Copyist.

W | *1 Cav* | *USCA*

Raphel Wright

Sgt, Co. K, 1 Reg't USCA

Appears on

Hospital Muster Roll

of **Corps d'Afrique U. S. A. General Hospital,**

at **New Orleans, La.,**

for *Nov & Dec*, 186*5*.

Attached to hospital:

When _____, 186 .

How employed _____

Last paid by Maj. _____

to _____, 186 .

Bounty paid \$ 100; due \$ 100

Present or absent _____

Remarks: *Discharged on Surg Cert. of disability Dec 23/65 F. I. given*

Book mark: _____

(343)

J. J. Johnson

Copyist.

W | 1 Cav. | U.S.C.T.

Raphael Wright

Pvt., Co. H., 1 Reg't U. S. Colored Cav.

Appears on Returns as follows:

Dec 18 64 Ft. Magruder
Va. Recruit Assgt. Dec 28/64

Aug 18 65 absent sick in
Post Hosp. Magruder.

Oct to Dec 18 65 absent sick
in Hosp at New Orleans La

Jan 18 66 Dec 23/65
New Orleans Dischgd
on Surgs cert of disability

Book mark:

Chas. Patton

(U) | 1 Cav. | U.S.C.T.

Raphael Wright
 Pt., Co. *A*, 1 Reg't U. S. Col'd Cavalry.

Appears on Co. Muster-out Roll, dated
Brazos Santiago Tex, Feb 4, 1866.
 Muster-out to date _____, 186 .
 Last paid to _____, 186 .

Clothing account:

Last settled _____, 186 ; drawn since \$ _____ 100
 Due soldier \$ _____ 100; due U. S. \$ _____ 100
 Am't for cloth'g in kind or money adv'd \$ _____ 100

Due U. S. for arms, equipments, &c., \$ _____ 100
 Bounty paid \$ _____ 100; due \$ _____ 100

Remarks: *Joined as Rect. Disch'd
 at Corps D'Arrique Hospit
 New Orleans La Dec 23/65
 Descriptive list furnished*

Book mark : _____

(361)

J. H. Stewart

Copyist.

Wright, Raphael

Cot, Co. H, 1 Reg't U.S.C. Cav.

2 Enclosures.

Bed Cards	Descriptive Lists
Burial Records	Final Statements
Certs. of Dis. for Discharge /	Furloughs
C. M. Charges	Med. Des. Lists
Med. Certificates	Orders

Other papers relating to—

Admission to Hosp'l	Furlough
Casualty Sheet (Officer's)	Med. Examination
Confinement	Misc. Information
Contracts	Pay or Clothing
Death or Effects	Personal Reports
Desertions	Rank
Discharge from Hosp'l	Transfer to Hosp'l
Discharge from Service	Transfer to V. R. C.
Duty	Transportation

NOTE 1.—This blank will be used for both enlistments and re-enlistments—enlistment of veterans, &c., &c., in the volunteer service. They will be made out in duplicate in all cases—one to accompany the recruiting return of the superintendent (not the recruiting officer) to the Adjutant General, and one to accompany the accounts of the officer who pays bounty, &c. The Regiment and Company in which the soldier last served should be given on the back.

NOTE 2.—An enlistment holds to service. A muster-in must, in all cases, precede payment of pay, bounty, pension, &c. A muster-in roll must, in all cases, be filed in the Adjutant General's Office as evidence of muster-in. The mustering officer, commissary, or assistant commissary of musters, as the case may be, will countersign both enlistments as having mustered the soldier into the service of the United States before either of them is given to the disbursing officer.

DECLARATION OF RECRUIT.

I, Raphael Wright desiring to VOLUNTEER as a Soldier in the Army of the United States, for the term of THREE YEARS, Do Declare, That I am Egyptian years and _____ months of age; that I have never been discharged from the United States service on account of disability or by sentence of a court-martial, or by order before the expiration of a term of enlistment; and I know of no impediment to my serving honestly and faithfully as a soldier for three years.

GIVEN at Storfolk Va the 21st day of December 1864

Witness: Joseph Selden Raphael Wright

1000
111
No. 72
Raphael Wright

Volunteered at St. Morris

Dec 22 1864

By W. M. Moore

37 Regiment of W. M. Moore

enlistment; last served in Company ()

1st Regt of 24th Cavalry

Discharged _____ 1864

CONSENT IN CASE OF MINOR.

I, _____ Do CERTIFY, That I am the _____ of _____; that the said _____ is _____ years of age; and I do hereby freely give my CONSENT to his volunteering as a SOLDIER in the ARMY OF THE UNITED STATES for the period of THREE YEARS.

GIVEN at _____ the _____ day of _____

Witness: _____

VOLUNTEER ENLISTMENT.

STATE OF

TOWN OF

Connecticut

at Large

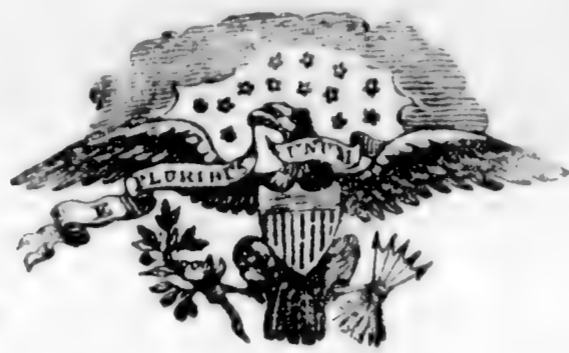

I, Raphael Wright born in Norfolk
 in the State of Virginia aged Eighteen years,
 and by occupation a Farmer Do HEREBY ACKNOWLEDGE to have
 volunteered this Twenty First day of December 1864
 to serve as a **Soldier** in the **Army of the United States of America**, for the
 period of **THREE YEARS** unless sooner discharged by proper authority: Do also
 agree to accept such bounty, pay, rations, and clothing, as are, or may be, estab-
 lished by law for volunteers. And I, Raphael Wright do
 solemnly swear, that I will bear true faith and allegiance to the **United States**
of America, and that I will serve them honestly and faithfully against all their
 enemies or opposers whomsoever; and that I will observe and obey the orders of
 the President of the United States, and the orders of the officers appointed over
 me, according to the Rules and Articles of War.

Sworn and subscribed to, at Fort Monroe
 this 22^d day of Dec 1864 } Raphael Wright
 BEFORE J. M. Monroe } his
Lt. 37th U.S.C.T. } mark

I CERTIFY, ON HONOR, That I have carefully examined the above-named Volunteer, agreeably
 to the General Regulations of the Army, and that, in my opinion, he is free from all bodily defects and
 mental infirmity, which would in any way disqualify him from performing the duties of a soldier.

W. C. Gray
Asst Surg 1st U.S.C.T.
 EXAMINING SURGEON.

I CERTIFY, ON HONOR, That I have minutely inspected the Volunteer, Wright
 previously to his enlistment, and that he was entirely sober when enlisted; that, to the best of my
 judgment and belief, he is of lawful age; and that, in accepting him as duly qualified to perform the duties
 of an able-bodied soldier, I have strictly observed the Regulations which govern the recruiting service.
 This soldier has Blk eyes, Blk hair, Blk complexion, is Five feet
Eight inches high.

James M. Monroe
Lt 37th Regiment of U.S.C.T. Volunteers,
 RECRUITING OFFICER.

(A. G. O. No. 74 & 76.)

Mustered into the service of the United States, in Company
 the 24th day of December, 1864, at Fort Monroe
Volunteer of 1st U.S.C.T.
1st Regiment of U.S.C.T. Volunteers, on
at Fort Monroe
at Fort Monroe
at Fort Monroe
at Fort Monroe

Headquarters, Department of Louisiana,
New Orleans, La., Dec. 21st 1865.

To be discharged.

By order of Major-General E. R. S. Canby:

E. R. S. Canby
Captain and A. A. G.

WHENEVER the injury...
in the line of his duty; and whenever other facts may aid
a judgment as to the cause, immediate or remote, of the
disability, and the circumstances attending it.
When the facts are not known to the company commander,
the certificate of any officer, or affidavit of other person
having such knowledge, will be appended—as the surgeon
in charge of a hospital, the officer commanding a detachment
of recruits, &c., &c.

NOTE 2.

When a probable case for pension, special care must be
taken to state the degree of disability—as 1/2, 3/4, &c., &c.;
to describe particularly the disability, wound, or disease;
the extent to which it deprives him of the use of any limb
or faculty, or affects his health, strength, activity, constitution,
or capacity to labor or earn his subsistence. The surgeon
will add, from his knowledge of the facts and circumstances,
and from the evidence in the case, his professional opinion
of the cause or origin of the disability. In the case of discharges
by Medical Inspectors, the last paragraph will state that the
“discharge was given by consent of the soldier, after a personal
examination, and for disability, the nature, degree, and origin of which
are correctly described in the within certificate.”

Par. 1260 Regulations, Edit. 1861.

Medical officers, in giving certificates of disability, are to
take particular care in all cases that have not been under
their charge; and especially in epilepsy, convulsions,
chronic rheumatism, derangement of the urinary organs,
ophthalmia, ulcers, or any obscure disease liable to be
feigned or purpose produced; and in no case shall such
certificate be given until after sufficient time and examination
to detect any attempt at deception.

DIRECTIONS.

This certificate will be made out in duplicate by the soldier's
company commander, or other officer commanding the separate detachment
to which he belongs, and sent by him to the surgeon who has
charge of the hospital where the soldier is sick. The surgeon will
then fill out and sign the surgeon's certificate, and forward these
papers to the regimental, detachment, or post commander, who will
forward them, with his action endorsed thereon, through the proper
channel, to his division commander; or, if the troops are not attached
to a division, to his corps, department, or other commander or officer
to whom the authority to discharge enlisted men may be specially
delegated.

These certificates, after having received the action of the highest
authority to which they are required to be sent, will be returned
through the same channel to the regimental, post, or detachment
commander, who will, if the discharge is authorized by the endorsement
of the proper authority, sign the soldier's discharge, and the last
certificate on this paper; see that the soldier is furnished with the
proper final statements in duplicate, and forward BOTH of these certificates
direct to the Adjutant-General, United States Army, at
Washington, D. C.; they will not, under any circumstances, be given
into the hands of the soldier.

ADJUTANT GENERAL'S OFFICE

John

Duplicate sent to Adjutant General

CERTIFICATE OF DISABILITY FOR DISCHARGE

IN THE CASE OF

1105 *24*
H 92th Reg't of Inf
Raphael Wright
a Private Co. "H"
1st Reg't of U.S.C.C.

Corps d'Afrique U. S. General Hospital.

New Orleans, La., Dec 18 1865

Respectfully Forwarded. *Discharge*
approved by board of
Examination
F. C. Fiquette
Surgeon & Medical Director
President of board

Imu

Received (A. G. Office) 186 .

Anton O. Reflex

Louisiana
New Orleans Dec 19 5
Respectfully forwarded to
The Adjutant General
General of the Department
Approved
J. H. ...
Artillery & Surgeon U.S. Army
Medical Director

ARMY OF THE UNITED STATES. CERTIFICATE OF DISABILITY FOR DISCHARGE.



Private Raphael Wright, of Captain Lieut Lewis A. Whitman's Company, (A) of the First Regiment of United States Col. Cary was enlisted by Lieut Monroe of the Regiment of at Fort Monroe Va on the Twenty-second day of December, 1864, to serve three years; he was born in Norfolk in the State of Virginia, is eighteen years of age, five feet eight inches high, fair complexion, blue eyes, fair hair, and by occupation when enlisted a Farmer. During the last two months said soldier has been unfit for duty 60 days.

STATION: Corps d'Afrique U.S. Gen Hosp. DATE: New Orleans La Dec. 18. 1865

F. E. Piquette Surgeon in Charge Commanding Company.

I CERTIFY that I have carefully examined the said Raphael Wright Private of Captain Lieut Whitman's Company, and find him incapable of performing the duties of a soldier because of Chronic Rheumatism contracted in line of duty since enlistment rendering him unfit for any branch of the service. Present degree of disability one quarter. He is not incapacitated from obtaining a livelihood in civil life.

J. Jackson Adj. Supt Surgeon. U.S.A.

DISCHARGED this Twenty-third day of December, 1865, at Corps d'Afrique U.S. Gen. Hosp. New Orleans La

F. E. Piquette Surgeon in Charge Commanding the Reg't

The Soldier desires to be addressed at

Town County State

* See Note 1 on the back of this. † See Note 2 on the back of this.

1321

Wright Richard

Co. A, 1 U. S. Col'd Cav.

Private Bugler

CARD NUMBERS.

1	5310927	26
2	5310796	27
8	5310868	28
4	5310939	29
5	5310965	30
6	5311041	31
7	5311132	32
8	5311222	33
9	5311328	34
10	5311435	35
11	5311538	36
12	5311642	37
13	5311743	38
14	5311844	39
15	5311944	40
16	9086570	41
17		42
18		43
19		44
20		45
21		46
22		47
23		48
24		49
25		50

ook Mark: V 88 P 169.69

ee also

W. | *1 Cav.* | **U.S.C.T.**

Richard Wright,

, Co. *H*, *1* Reg't U. S. Col'd *Cav.*

Appears on

Company Descriptive Book

of the organization named above.

DESCRIPTION.

Age *20* years; height *5* feet *4* inches.

Complexion *Black.*

Eyes *Black*; hair *Black.*

Where born *Suffolk V.*

Occupation

ENLISTMENT.

When *Dec 14*, 186*3*.

Where *Norfolk.*

By whom *Capt Brown*; term *3* y'rs.

Remarks:

Dickerson,

61 | 1 Cav. | U.S.C.T.

William Smith

Co. 1st, 1 Reg't U. S. Col'd Cavalry.

Age *20* years.

Appears on

Company Muster-in Roll

of the organization named above. Roll dated

August 1st, 186*3*.

Muster-in to date *August 1st*, 186*3*.

Joined for duty and enrolled:

When *June 1st*, 186*3*.

Where *Fort Smith*

Period *2* years.

Valuation of horse, \$ 100

Valuation of horse equipments, \$ 100

Remarks:

Book mark:-----

(356)

William Smith
Coptst.

21 | **1 Cav.** | **U.S.C.T.**

Richard Wright

2nd, Co. H, 1 Reg't U. S. Col'd Cavalry.

Appears on

Company Muster Roll

for *March 1st*, 186*1*.

Present or absent *Present*

Stoppage, \$ *100* for

Due Gov't, \$ *100* for

Valuation of horse, \$ *100*

Valuation of horse equipments, \$ *100*

Remarks:

Book mark:

(358)

J. C. Edwards
Copyist.

21 | 1 Cav. | U.S.C.T.

Richard Wright

Capt., Co. H, 1 Reg't U. S. Col'd Cavalry.

Appears on

Company Muster Roll

for Jan & Feb, 1864.

Present or absent Present

Stoppage, \$ 100 for

Due Gov't, \$ 100 for

Valuation of horse, \$ 100

Valuation of horse equipments, \$ 100

Remarks:

.....
.....
.....
.....
.....
.....
.....
.....
.....
.....

Book mark:

.....

(358)

W. R. [Signature]
Copyist.

1 Cav. U.S.C.T.

Edward Grant

Grant, Co. H, 1 Reg't U. S. Col'd Cavalry.

Appears on

Company Muster Roll

for *March 1864*, 1864.

Present or absent *Present*

Stoppage, \$ *100* for

Due Gov't, \$ *100* for

Valuation of horse, \$ *100*

Valuation of horse equipments, \$ *100*

Remarks:

Book mark:

(358)

Edward Grant
Copyist.

41 | 1 Cav. | U.S.C.T.

Richard Smith

Private, Co. H, 1 Reg't U. S. Col'd Cavalry.

Appears on

Company Muster Roll

for *May 1st 1864*, 1864.

Present or absent *Present*

Stoppage, \$ *100* for

Due Gov't, \$ *100* for

Valuation of horse, \$ *100*

Valuation of horse equipments, \$ *100*

Remarks:

*Appointed Surgeon
May 20, 1864*

Book mark:

1 Cav. U.S.C.T.

[Handwritten signature]

[Handwritten name], Co. H, 1 Reg't U. S. Col'd Cavalry.

Appears on

Company Muster Roll

for *[Handwritten date]*, 186*[Handwritten year]*.

Present or absent *[Handwritten status]*

Stoppage, \$ *[Handwritten amount]* for *[Handwritten reason]*

Due Gov't, \$ *[Handwritten amount]* for *[Handwritten reason]*

Valuation of horse, \$ *[Handwritten amount]*

Valuation of horse equipments, \$ *[Handwritten amount]*

Remarks: *[Handwritten notes]*

Book mark: *[Handwritten mark]*

(358)

[Handwritten signature]

Copyist.

A | 1 Cav. | U.S.C.T.

Richard Knight

Reg't, Co. H, 1 Reg't U. S. Col'd Cavalry.

Appears on

Company Muster Roll

for *Sept - Dec*, 186*4*.

Present or absent *Present*

Stoppage, \$ *100* for

Due Gov't, \$ *100* for

Valuation of horse, \$ *100*

Valuation of horse equipments, \$ *100*

Remarks:

Book mark:

(358)

J. Jackson

Copyist.

24

1 Cav. U.S.C.T.

Richard Knight

Quail, Co. H, 1 Reg't U. S. Col'd Cavalry.

Appears on

Company Muster Roll

for *Nov Dec*, 186*4*

Present or absent *Present*

Stoppage, \$ *100* for

Due Gov't, \$ *100* for

Valuation of horse, \$ *100*

Valuation of horse equipments, \$ *100*

Remarks:

Book mark:

(358)

J. Jackson
Copyist.

H | 1 Cav. | U.S.C.T.

Richard Wright

Bugler, Co. H, 1 Reg't U. S. Col'd Cavalry.

Appears on

Company Muster Roll

for *Jan - Feb*, 186 *5*.

Present or absent *Present*

Stoppage, \$ *100* for

Due Gov't, \$ *100* for

Valuation of horse, \$ *100*

Valuation of horse equipments, \$ *100*

Remarks:

Book mark:

(358)

O. M. Jackson

Copyist.

A | 1 Cav. | U.S.C.T.

Richard Wright

Wright, Co. H, 1 Reg't U. S. Col'd Cavalry.

Appears on

Company Muster Roll

for *March - April*, 1865.

Present or absent *Present*

Stoppage, \$ *100* for

Due Gov't, \$ *100* for

Valuation of horse, \$ *100*

Valuation of horse equipments, \$ *100*

Remarks:

Book mark:

(358)

J. M. Jackson
Copyist.

21 | **1 Cav. | U.S.C.T.**

Richard Bright

Bugler, Co. H, 1 Reg't U. S. Col'd Cavalry.

Appears on

Company Muster Roll

for *May-June*, 186 *5*.

Present or absent *Present*

Stoppage, \$ *100* for

Due Gov't, \$ *100* for

Valuation of horse, \$ *100*

Valuation of horse equipments, \$ *100*

Remarks:

Book mark: -----

(358)

R. M. Jackson
Copyist.

A | 1 Cav. | U.S.C.T.

Richard Knight

Reg't Co. H, 1 Reg't U. S. Col'd Cavalry.

Appears on

Company Muster Roll

for *July & Aug*, 186 *5*.

Present or absent *Present*

Stoppage, \$ *100* for

Due Gov't, \$ *100* for

Valuation of horse, \$ *100*

Valuation of horse equipments, \$ *100*

Remarks:

Book mark:

(358) *M Jackson* Copyist.

W | 1 Cav. | U.S.C.T.

Richard Wright

Bugler, Co. H, 1 Reg't U. S. Col'd Cavalry.

Appears on

Company Muster Roll

for Sept & Oct, 1865.

Present or absent Present

Stoppage, \$ 100 for

Due Gov't, \$ 100 for

Valuation of horse, \$ 100

Valuation of horse equipments, \$ 100

Remarks:

Book mark:

J. H. Stewart

(358)

Copyist.

W | **1 Cav.** | **U.S.C.T.**

Richard Wright

Dugler, Co. H, 1 Reg't U. S. Col'd Cavalry.

Appears on

Company Muster Roll

for *Nov & Dec*, 186 *2*

Present or absent *Present*

Stoppage, \$ 100 for

Due Gov't, \$ 100 for

Valuation of horse, \$ 100

Valuation of horse equipments, \$ 100

Remarks:

Book mark:

M Stewart

(358)

Copyist.

W | 1 Cav. | U.S.C.T.

Richard Wright

Bugler, Co. K, 1 Reg't U. S. Col'd Cavalry.

Appears on Co. Muster-out Roll, dated

Brazos Santiago Tex, Feb 4, 1866.

Muster-out to date Feb 4, 1866.

Last paid to Aug 31, 1865.

Clothing account:

Last settled _____, 186 ; drawn since \$ _____ 100

Due soldier \$ / 3 37 / 100; due U. S. \$ _____ 100

Am't for cloth'g in kind or money adv'd \$ _____ 100

Due U. S. for arms, equipments, &c., \$ _____ 100

Bounty paid \$ _____ 100; due \$ _____ 100

Remarks: Joined at Org reg

Book mark: ✓ 88 P 162.69

(361)

J. H. Stewart

Copyist.

1528

Wright William

Co H, 1 U. S. Col'd Cav.

Private

Private

CARD NUMBERS.

1	5310729	26
2	5310798	27
3	5310870	28
4	5310941	29
5	5311014	30
6	5300273	31
7	5300364	32
8	5311097	33
9	5311188	34
10	5311292	35
11	5311397	36
12	5311502	37
13	5311603	38
14	5311707	39
15	5311807	40
16	5311906	41
17	5312004	42
18	9086572	43
19		44
20		45
21		46
22		47
23		48
24		49
25		50

Book Mark:

See also

930342 - P.O. MEM

Wang, E.

N. | *1 Cav.* | **U.S.C.T.**

William Wright

, Co. *H*, *1* Reg't U. S. Col'd *Cav.*

Appears on

Company Descriptive Book

of the organization named above.

DESCRIPTION.

Age *19* years; height *5* feet *4* inches.

Complexion *Black.*

Eyes *Black*; hair *Black*

Where born *Princess Ann V.*

Occupation _____

ENLISTMENT.

When *Dec 12*, 186*3*.

Where *Norfolk.*

By whom *Capt Brown*; term *3* y'rs.

Remarks: _____

Dickerson

| **1 Cav. | U.S.C.T.**

William Wright

 , Co. , 1 Reg't U. S. Col'd Cavalry.

Age 19 years.

Appears on

Company Muster-in Roll

of the organization named above. Roll dated

 , 186 .

Muster-in to date , 186 .

Joined for duty and enrolled:

When , 186 .

Where

Period years.

Valuation of horse, \$ ¹⁰⁰

Valuation of horse equipments, \$ ¹⁰⁰

Remarks:

Book mark:

64 | 1 Cav. | U.S.C.T.

William Wright

Priv., Co. H, 1 Reg't U. S. Col'd Cavalry.

Appears on

Company Muster Roll

for *Dec 22 53*, 1863.

Present or absent *Present*

Stoppage, \$ *100* for

Due Gov't, \$ *100* for

Valuation of horse, \$ *100*

Valuation of horse equipments, \$ *100*

Remarks:

Book mark:

W. A. Edwards

Copyist.

C1 | **1 Cav. | U.S.C.T.**

William Wright

Priv., Co. H, 1 Reg't U. S. Col'd Cavalry.

Appears on

Company Muster Roll

for *Jan & Feb*, 1864.

Present or absent *Present*

Stoppage, \$ *100* for

Due Gov't, \$ *100* for

Valuation of horse, \$ *100*

Valuation of horse equipments, \$ *100*

Remarks:

Book mark:

W. R. Edwards

(358)

Copyist.

A | **1 Cav.** | **U.S.C.T.**

Wm. Vincent

Wm. Vincent, Co. H, 1 Reg't U. S. Col'd Cavalry.

Appears on

Company Muster Roll

for *September*, 186*4*.

Present or absent *Present*

Stoppage, \$ *100* for

Due Gov't, \$ *100* for

Valuation of horse, \$ *100*

Valuation of horse equipments, \$ *100*

Remarks:

Book mark:

(358)

Wm. Vincent

Copyist.

11 | *100* | U.S.C.T.

100
100, Co. *7*, Reg't U. S. Col'd. *100*

Appears on

Company Muster Roll

for *100*, 186*7*.

Present or absent *100*

Stoppage, \$ *100* for

Due Gov't, \$ *100* for

Valuation of horse, \$ *100*

Valuation of horse equipments, \$ *100*

Remarks:
100
100
100
100

Book mark:

(358)

100
Copyist.

W. I. Cav | U.S.C.T.

William Bright

, Co., 1 Reg't U. S. Col'd Cavalry

Appears on a

Detachment Muster Roll

of the organization named above

for May & June, 1864

Station in the field Va. near Petersburg

Present or absent Present

Stoppage, \$ 100 for

Due Gov't, \$ 100 for

Valuation of horse, \$ 100

Valuation of horse equipments, \$ 100

Remarks :

Book mark :

W. I. Cav

(344)

Copyist.

Dr 1 1 car | **U.S.C.T.**

* Wright

Pvt, Co., 1 Reg't U. S. Col'd Carly

Appears on a

Detachment Muster Roll

of the organization named above

for May & June, 1864.

Station Battlefield Hosp^l near Petersburg Va

Present or absent not stated

Stoppage, \$ 100 for

Due Gov't, \$ 100 for

Valuation of horse, \$ 100

Valuation of horse equipments, \$ 100

Remarks: Descriptive roll not sent

* As shown on roll

Filed with William Wright

Book mark:

(344) Hammer Copyist.

1 Cav. U.S.C.T.

....., Co. H, 1 Reg't U. S. Col'd Cavalry.

Appears on

Company Muster Roll

for, 186.....

Present or absent

Stoppage, \$.....¹⁰⁰ for

Due Gov't, \$.....¹⁰⁰ for

Valuation of horse, \$.....¹⁰⁰

Valuation of horse equipments, \$.....¹⁰⁰

Remarks:

Book mark:

(358)

Copyist.

N | 1 Cav. | U.S.C.T.

John Wright

Priv, Co. H, 1 Reg't U. S. Col'd Cavalry.

Appears on

Company Muster Roll

for *Sept & Oct*, 186*4*.

Present or absent *Present*

Stoppage, \$ *100* for

Due Gov't, \$ *100* for

Valuation of horse, \$ *100*

Valuation of horse equipments, \$ *100*

Remarks:

Book mark: -----

(358)

W Jackson

Copyist.

H | 1 Cav. | U.S.C.T.

William Wright
Plt, Co. H, 1 Reg't U. S. Col'd Cavalry.

Appears on

Company Muster Roll

for *Mo. De C*, 186 *4*

Present or absent *Present*

Stoppage, \$ *100* for

Due Gov't, \$ *100* for

Valuation of horse, \$ *100*

Valuation of horse equipments, \$ *100*

Remarks:
.....
.....
.....
.....
.....
.....
.....
.....
.....
.....

Book mark:

(358)

M Jackson
Copyist.

24 | 1 Cav. | U.S.C.T.

William Wright

Priv, Co. H, 1 Reg't U. S. Col'd Cavalry.

Appears on

Company Muster Roll

for *Jan - Feb*, 1865.

Present or absent *Present*

Stoppage, \$ *100* for

Due Gov't, \$ *100* for

Valuation of horse, \$ *100*

Valuation of horse equipments, \$ *100*

Remarks:

Book mark: -----

(358)

W Jackson
Copyist.

2 | **1 Cav.** | **U.S.C.T.**

William Bright

Plt....., Co. H, 1 Reg't U. S. Col'd Cavalry.

Appears on

Company Muster Roll

for *Men & Apl*....., 1865.

Present or absent *Present*.....

Stoppage, \$..... $\overline{100}$ for.....

Due Gov't, \$..... $\frac{30}{100}$ for *advance*.....

Valuation of horse, \$..... $\overline{100}$

Valuation of horse equipments, \$..... $\overline{100}$

Remarks: *For med (1)*
laber

Book mark:.....

(358)

M Jackson

Copyist.

27 | cad | U.S.C.T.

William Wright
Co., Co. 4, Reg't U. S. Col'd cad

Appears on

Company Muster Roll

for May & June, 1865.

Present or absent Present

Stoppage, \$ 100 for

Due Gov't, \$ 100 for

Valuation of horse, \$ 100

Valuation of horse equipments, \$ 100

Remarks: Due US Gov
our share May 30

Book mark:

(358)

W Jackson

Copyist.

27 | 1 Cav. | U.S.C.T.

William Knight

Capt., Co. H, 1 Reg't U. S. Col'd Cavalry.

Appears on

Company Muster Roll

for July-Aug, 1862.

Present or absent Present

Stoppage, \$ 100 for

Due Gov't, \$ 100 for

Valuation of horse, \$ 100

Valuation of horse equipments, \$ 100

Remarks: Due U.S. for
over U.S. Sabie Knot 308

Book mark:

(358)

M Jackson

Copyist.

W | **1 Cav.** | **U.S.C.T.**

Wm Wright

Pt, Co. H, 1 Reg't U.S. Col'd Cavalry.

Appears on

Company Muster Roll

for *Sept & Oct*, 186*5*.

Present or absent *Present*

Stoppage, \$ *100* for

Due Gov't, \$ *100* for

Valuation of horse, \$ *100*

Valuation of horse equipments, \$ *100*

Remarks:

Book mark: _____

J. Stewart

(358)

Copyist.

W | 1 Cav. | U.S.C.T.

William Wright

Pt, Co. H, 1 Reg't U. S. Cold Cavalry.

Appears on

Company Muster Roll

for Nov & Dec, 1865.

Present or absent Present

Stoppage, \$ 100 for

Due Gov't, \$ 100 for

Valuation of horse, \$ 100

Valuation of horse equipments, \$ 100

Remarks:

Book mark:

J. H. Stewart

(358)

Copyist.

W | **1 Cav.** | **U.S.C.T.**

William Wright

Pt, Co. *K*, 1 Reg't U. S. Col'd Cavalry.

Appears on **Co. Muster-out Roll**, dated

Brazos Santiago Tex, Feb 4, 1866.

Muster-out to date *Feb 4*, 1866.

Last paid to *Aug 31*, 1865.

Clothing account:

Last settled _____, 186 ; drawn since \$ _____ 100

Due soldier \$ _____ 100; due U. S. \$ *11* ^{*64*}/₁₀₀

Am't for cloth'g in kind or money adv'd \$ _____ 100

Due U. S. for arms, equipments, &c., \$ _____ 100

Bounty paid \$ _____ 100; due \$ _____ 100

Remarks: *Joined at Org Org*

Book mark : _____

(361)

J. H. Hewart

Copyist.

1529

Wurdschmann, Ferdinand H.

Co F, 1 U. S. Col'd Cav.

Personal papers herein.

1st Lieutenant 2nd Lieutenant

CARD NUMBERS.

1	5309277	26
2	5299277	27
3	5308884	28
4	5308993	29
5	5309180	30
6	9435796	31
7	9435872	32
8	B 372 - C.T. - 1865.	33
9	40725551	34
10		35
11		36
12		37
13		38
14		39
15		40
16		41
17		42
18		43
19		44
20		45
21		46
22		47
23		48
24		49
25		50

Book Mark: { G. 348 Vol 5, C.T. 1865 with
B 372 - C.T. - 1865.

See also 1st N.Y. Engineers

W. I. Cav. U.S.C.T.

F. H. Wundersmann

2d, Co. _____, _____ Reg't U. S. Col'd *Cav.*

Appears on

Regimental Descriptive Book

(List of Commissioned Officers)

of the regiment named above.

Rank *2d Lt*

Date of appointment *13 June* 186*6*

Remarks: _____

Danton

W. | 1. Cav | U.S.
Ferdinand H. Mordman,
2 Lt., Co. , 1. Reg't U.S. Col'd Cav.

Appears on

Regimental Descriptive Book
(List of Commissioned Officers)

of the regiment named above.

Rank *2 Lt*

Date of appointment....., 186 .

Remarks :

.....
.....
.....
.....
.....
.....
.....
.....
.....
.....
.....
.....
.....
.....
.....
.....

D. Dayton,

W | 1st Cav. | **U.S.C.T.**

Ferdinand H. Murdemann

2nd Lt, Co., 1st Reg't U. S. Col'd Cav.

Age 23 years.

Appears on an

Individual Muster-in Roll

of the organization named above. Roll dated

Brazos Santiago Tex, July 24, 1865.

Muster-in to date July 23, 1865.

Joined for duty and enrolled :

When July 23^d, 1865.

Where Brazos Santiago Tex.

Period 3 years.

Valuation of horse, \$ 100

Valuation of horse equipments, \$ 100

Remarks : Promoted from artificer 1st N.Y.
Eng. vice 2nd Lt. A.C. Sharp resigned.
Discharge from 1st N.Y. Engineers dated,
June 23, 1865.

Book mark : B 372 - E.T. - 1865.

Crenshaw

(336)

Copyist.

W

1 Cav. | U.S.C.T.

Ferdinand H Hurdemann

2^d Lt, Co. F, 1 Reg't U. S. Col'd Cavalry.

Appears on

Company Muster Roll

for *July & Aug*, 1865.

Present or absent *not stated*

Stoppage, \$ *100* for

Due Gov't, \$ *100* for

Valuation of horse, \$ *100*

Valuation of horse equipments, \$ *100*

Remarks:

Book mark:

(358)

J. H. Leonard

Copyist.

W. | **1 Cav.** | **U.S.C.T.**

Fred. H. Mordeman

2d Lieut., Co. F, 1 Reg't U. S. Col'd Cavalry.

Appears on

Company Muster Roll

for *Sept. Aug Oct.*, 186*5*.

Present or absent *Present*

Stoppage, \$ *100* for

Due Gov't, \$ *100* for

Valuation of horse, \$ *100*

Valuation of horse equipments, \$ *100*

Remarks: *(Harrest)*

Book mark:

B. J. Cooke

(358)

Copyist.

W. | 1 Cav. | U.S.C.T.

Fred C. Mordemann
2d Lieut, Co. F, 1 Reg't U. S. Col'd Cavalry.

Appears on

Company Muster Roll

for *Nov. & Dec*, 186 *5*.

Present or absent.....

Stoppage, \$.....100 for.....

Due Gov't, \$.....100 for.....

Valuation of horse, \$.....100

Valuation of horse equipments, \$.....100

Remarks: *Dismissed S. G. M.*
Nov. 3rd 1865

Book mark:

B. J. Cooke

(358)

Copyist.

W | 1 Cav. | U.S.C.T.

Ferd. H. Mordmann
2 Lt., Co. F., 1 Reg't U. S. Colored Cav.

Appears on Returns as follows:

<i>July 18 63</i>	<i>Present</i>
	<i>Appointed June 13/63</i>
<i>Aug 18 63</i>	<i>Present</i>
<i>Sept 18 63</i>	<i>Present</i>
	<i>in arrest</i>
<i>Oct 18 63</i>	<i>Present</i>
	<i>awaiting sentence</i>
<i>Nov 18 63</i>	<i>Dismissed Nov</i>
	<i>4/63 for Gen. C. M. orders</i>
	<i>Mr. J. H. Gos. Dept of P. & M.</i>
	<i>Oct 24/63</i>

Book mark:

F. H. Mordmann

W. | **1 Cav. | U.S.C.T.**

Ferdinand H. Gurdemann
2^d Lieut., Co. F, 1 Reg't U. S. Col'd Cavalry.

Appears on **Co. Muster-out Roll**, dated
Progreso, Santiago, Tex, Feb 4, 1866.

Muster-out to date _____, 186 .

Last paid to _____, 186 .

Clothing account:

Last settled _____, 186 ; drawn since \$ _____ 100

Due soldier \$ _____ 100; due U. S. \$ _____ 100

Am't for cloth'g in kind or money adv'd \$ _____ 100

Due U. S. for arms, equipments, &c., \$ _____ 100

Bounty paid \$ _____ 100; due \$ _____ 100

Remarks: *Discharged, dismissed by sentence of Genl Court Martial Order No. 4 Oct. 24th 65 (H'd Co Dpt Texas, Galveston Tx)*

Book mark: *7348, M. 5, C. 9, 1865.*

(361)

B. J. Cook

Copyist.

W | 1st Cav. | U. S. C. S.

Ferdinand H. Werdeman

, Co. , 1st Reg't U. S. C. Cav.

NOTATION.

Book mark: { 7348 - O. P. - 65 with
B-372 - C - J - 1865.

War Department,

Adjutant General's Office,

Washington, July 16, 1883.

See also Co. K. 1st N. Y. Engrs.

W. Allen

(488)

Copyist.

Wurdeman, Ferdinand H.

2^d Lt, Co.

1st Reg^t U.S.C. Cav.

5 Enclosures.

Bed Cards	Descriptive Lists
Burial Records	Final Statements
Certs. of Dis. for Discharge	Furloughs
C. M. Charges	Med. Des. Lists
Med. Certificates	Orders 2

Other papers relating to—

Admission to Hosp'l	Furlough
Casualty Sheet (Officer's)	Med. Examination
Confinement /	Misc. Information
Contracts	Pay or Clothing
Death or Effects	Personal Reports
Desertions	Rank 3/
Discharge from Hosp'l	Transfer to Hosp'l
Discharge from Service	Transfer to V. R. C.
Duty	Transportation /

H. D. Appleton Office
New York June 14/65

Murderer, ...
1st ...
1st ...
1st ...

Del Geo 25th A.C.
Brazos Santiago, Texas.
A. 3 P.M. July 1, 1865

Respectfully transmitted

By Command of
Maj Genl Witzel
D. G. ...
Lieut ...

A. 16 P.M. July 8/65

War Department
 Adjutant General's Office
 Washington, June 14th 1865

Commanding Officers
 1st U. S. Colored Cavalry,
 (Thro. Ad. Quartr. 25th Army Corps)
 New Orleans La.

Sir:-

I have the honor to
 inform you that Ferdinand K. Gurdeman
 has been appointed 2^d Lieutenant, 1st U. S.
 Colored Cavalry.

Very Respectfully,
 Your Obedient Servant,
 C. W. Foster

As. As. Genl. Vols.

(B 372, vol. 4, c. 2, 1865.)

Record and Pension Office,

WAR DEPARTMENT.

The slip hereto attached is a stub from
 "Requisition for Transportation Book,"
 Department of Washington.

U. S. REQUISITION FOR TRANSPORTATION.

No. *39*
 Date: *June 27/1864*
 For *1st Lt. Mendenham*
 Reg't *1st Reg't 116th Gunny*
 From *Washington DC*
 To *Army Ordnance Dept*
 Nature of Service: *To report on work*
manuscript filed

F. H. Wurdeman
L L 1-

C. M. Charges.

Hd Qrs 3rd Div 25th U.C.
 Brazos Santiago Texas
 August 26th 1865

General
 Court Martial Orders } Extract
 No 2

Before a General Court
 Martial which convened at Hd Qrs 3rd Div 25th U.C.
 pursuant to Special Order No 18 of Aug 3rd 1865
 from Hd Qrs 3rd Div 25th U.C. and of which Major
 William H. Critt 1st U.S.C. is President
 has assigned and tried

9th 2nd Lieut F H Wurdeman 1st U.S.C. on
 on the following Charges and Specifications
 Charges of Conduct unbecoming and Officer
 and a Gentleman

Specification In this that 2nd Lieut F H
 Wurdeman 1st U.S.C. on the 14th day of August
 1865 while on duty as Officer of the Guard
 of Post of Brazos Santiago Texas did go to and
 Private Keenan Sanders Co I 56th U.S.C. Troops
 who belong to the Headquarters Guard at Hd Qrs
 3rd Div B.A.G. and who was at the time a mem-
 ber of that Guard posted as a sentry over the
 horses and forage, belonging to Hd Qrs 3rd Div 25th U.C.
 and in charge thereof and did order the said
 Private Sanders to leave his post and get him
 some corn for his horse from the forage then in
 his charge belonging to Hd Qrs 3rd Div 25th U.C.
 he the said Lieut Wurdeman well knowing at
 the time that he had no command of the said
 sentry and when the said Private Keenan Sanders
 remonstrated and told him the said Lieut Wurdeman
 that he could not leave his post and

that no one but the General Servant could have the forage
 he the said Lieut Wurdeman in an excited manner
 called the said Private Sanders a Son of Bitch
 and cursed him and used divers other profane
 expressions and at said time threatened to tie
 him up and this while said Sanders was at
 his Post in obedience to the orders that had
 been properly given him
 Charge 2^d Conduct to the prejudice of good order
 and Military discipline
 Specifications "In this" that 2^d Lieut F. Wurdeman
 18 U.S.C. on the 14th day of Aug 1855 while on
 duty as Officer of the Guard at the Post of Hayes
 2^d Artillery was directed to send Private Reuben Sanders
 36 U.S.C. Troops who belong to the 1st Hd Regt
 at Hd Qrs 3^d Div 25 U.S.C. and in charge of
 and did order the said Private Sanders to leave
 his Post and go and get him some Corn for his
 horse from the forage then in charge of said
 Sanders belonging to Hd Qrs 3^d Div 25 U.S.C.
 They said Lieut Wurdeman well knowing at the time
 that he had no command of the said Sentry
 and when the said Private Reuben Sanders remon-
 strated and told the said Lt Wurdeman that
 he could not leave his Post and no one but the
 Genl Servant could have the forage he the said
 Lt Wurdeman called the said Private Reuben
 Sanders a "Son of Bitch" and at the same
 time used divers other profane ^{and unbecoming} expressions and
 threatened to tie him up and this while said
 Sanders was at his Post in obedience to the
 orders that had been properly given him
 To which Charge and Specifications the ac-
 cused pleaded as follows.

To the Specification 1st Charge Not guilty
 To the 1st Charge Not guilty
 To the Specification 2nd Charge Not guilty
 To the 2nd Charge Not guilty

Findings of the Court
 The Court having maturely considered the evidence adduced do find the said accused 2nd Lieut F. H. Murdeman 1st U. S. G. C. as follows

On the Specification 1st Charge Guilty
 Of the 1st Charge Guilty
 Of the Specification 2nd Charge Guilty
 Of the 2nd Charge Guilty

Sentence
 And the Court do therefore sentence him the said 2nd Lieut F. H. Murdeman P. U. S. C. to be dismissed the service

X The proceedings findings and sentence in the following case of 2nd Lieut F. H. Murdeman 1st U. S. G. C. are approved and confirmed and the sentence will be carried into execution

By Order of Court District of Columbia
 P. W. Bacon
 1st Lieut and Adj. 36th U. S. C. Troops

Brown, Santiago, Texas.

W 44 = 3D, 25 A (C) Sept 6th 1865.

Murdeman, F. W.

2nd Lieut, 1st U.S.C. Co.

Requests limits of
Confinement be
extended;

Filed 12-26-93

For file 31, 25, 26, 27, 28, 29, 30, 31, 32, 33, 34, 35, 36, 37, 38, 39, 40, 41, 42, 43, 44, 45, 46, 47, 48, 49, 50, 51, 52, 53, 54, 55, 56, 57, 58, 59, 60, 61, 62, 63, 64, 65, 66, 67, 68, 69, 70, 71, 72, 73, 74, 75, 76, 77, 78, 79, 80, 81, 82, 83, 84, 85, 86, 87, 88, 89, 90, 91, 92, 93, 94, 95, 96, 97, 98, 99, 100

Col. Geo W. H. S. Co.
 Brazos Santrago Co. Sept 16/65

Respectfully forwarded
Disapproved:

Wm. H. Seip,
 Maj. Comdg. Regt.

213. 11. 5. 213 35 2168

1st In. 2nd 1 Brigade
 3rd Div. 25th U.S.

Comdg. Infantry Co.
 1st Regt. of 1865.

Respectfully forwarded
 Disapproved
 James Lewis

Lieut. Col. 127. 1865.
 Comdg. 1 Brigade.

Brays, Santiago, Texas.
Sept. 6th. 1865.

1st Lieut. James W. Bacon
A. A. A. Gen. 3rd Div. 25th A. I.

Sir,

I have the
honor, respectfully to request, that
the limits of my confinement
be extended to include those of
the Post of Brays, Santiago, Texas.

Respectfully, Your
Obedt Servt.

F. H. Muddemann

2nd Lieut. 1st U.S.C. Co

Old In-land. Pic - a - 500000.
Murray's Landing Sept 17/15

General orders

No. 16

Do much of the same
as it appears the sentence
of the Lt. Col. G. Hardeman
with the 1st Co. 1st Regt. 1st Div.

Ad. No. 3rd Div 25th A.C.
Bureau Santiago
Sept. 9 1865

General Orders
No. 16

In view of G. C. M. C.
No. 2. from these Ad. No. as approved the
sentence of 2nd Lt. W. H. Murdeman 1866
is hereby recalled.

By order of Brig. Genl Clark
L. H. Drown
1st Lt. Regt. 36th U.S. Inf.
A. A. G.

Ad. No. 3rd Div 25th A.C.

1580

Wyatt Godfrey

Co H, 1 U. S. Col'd Cav.

Engler

Private

CARD NUMBERS.

1	5310683	26
2	5310752	27
3	5310822	28
4	5310894	29
5	5310964	30
6	5311040	31
7	5311131	32
8	5311221	33
9	5311327	34
10	5311434	35
11	5311537	36
12	5311641	37
13	5311742	38
14	5311921	39
15	5312016	40
16	9086508	41
17	W-57-C.T. 74	42
18	4072553	43
19		44
20		45
21		46
22		47
23		48
24		49
25		50

Book Mark W-57-C.T. 74

See also

W. | *1 Cav.* | **U.S.C.T.**

Godfrey Wyatt.

, Co. *W*, *1* Reg't U. S. Col'd *Cav.*

Appears on

Company Descriptive Book

of the organization named above.

DESCRIPTION.

Age *18* years; height *5* feet *8* inches.

Complexion *Yellow*

Eyes *Black*; hair *Black.*

Where born *Goucester, Va.*

Occupation _____

ENLISTMENT.

When *Dec 14*, 186*3*.

Where *Norfolk,*

By whom *Capt Brown*; term *3* y'rs.

Remarks: _____

Dickerson.

(383g)

Copyist.

Q | **1 Cav.** | **U.S.C.T.**

Andrew Small

Quar., Co. *H*, 1 Reg't U. S. Col'd Cavalry.

Age *18* years.

Appears on

Company Muster-in Roll

of the organization named above. Roll dated

Hamilton, Tenn., 186*3*.

Muster-in to date *Jan 2*, 186*3*.

Joined for duty and enrolled:

When *Dec 17*, 186*2*.

Where *Franklin, Tenn.*

Period *3* years.

Valuation of horse, \$ *100*

Valuation of horse equipments, \$ *100*

Remarks:

Book mark: *W-57-Q.T. 74*

(356)

Andrew Small
Copyist.

1 Cav. U.S.C.T.

William Grant

William Grant, Co. H, 1 Reg't U. S. Col'd Cavalry.

Appears on

Company Muster Roll

for *Dec 22 1865*, 186*5*.

Present or absent *Present*

Stoppage, \$ *100* for

Due Gov't, \$ *100* for

Valuation of horse, \$ *100*

Valuation of horse equipments, \$ *100*

Remarks:

Book mark:

William Grant

(358)

Copyist.

1 Cav. U.S.C.T.

..., Co. H, 1 Reg't U. S. Col'd Cavalry.

Appears on

Company Muster Roll

for ..., 186...

Present or absent

Stoppage, \$ 100 for

Due Gov't, \$ 100 for

Valuation of horse, \$ 100

Valuation of horse equipments, \$ 100

Remarks:

Book mark:

11 | 1 Cav. | U.S.C.T.

Henry Smith

Company, Co. II, 1 Reg't U. S. Col'd Cavalry.

Appears on

Company Muster Roll

for March 1864, 1864.

Present or absent Present

Stoppage, \$ 100 for

Due Gov't, \$ 100 for

Valuation of horse, \$ 100

Valuation of horse equipments, \$ 100

Remarks:

Book mark :

(358)

Henry Smith

Copyist.

1 Cav. U.S.C.T.

Andrew ...

..., Co. H, 1 Reg't U. S. Col'd Cavalry.

Appears on

Company Muster Roll

for *...*, 186*4*.

Present or absent *Present*

Stoppage, \$ *100* for

Due Gov't, \$ *100* for

Valuation of horse, \$ *100*

Valuation of horse equipments, \$ *100*

Remarks:

Book mark:

1 Cav. U.S.C.T.

James P. ...
..., Co. H, 1 Reg't U. S. Col'd Cavalry.

Appears on

Company Muster Roll

for ..., 186 ...

Present or absent *Present*

Stoppage, \$ 100 for

Due Gov't, \$ 100 for

Valuation of horse, \$ 100

Valuation of horse equipments, \$ 100

Remarks:

.....
.....
.....
.....
.....
.....
.....

Book mark:

.....

24 | 1 Cav. | U.S.C.T.

Godfrey Bryant

Reg't, Co. H, 1 Reg't U. S. Col'd Cavalry.

Appears on

Company Muster Roll

for *Sept Oct*, 186*4*.

Present or absent *Present*

Stoppage, \$ *100* for

Due Gov't, \$ *100* for

Valuation of horse, \$ *100*

Valuation of horse equipments, \$ *100*

Remarks:

Book mark:

J. Jackson
Copyist.

A | 1 Cav. | U.S.C.T.

Godfrey Hyatt

Regt, Co. H, 1 Reg't U. S. Col'd Cavalry.

Appears on

Company Muster Roll

for *Nov & Dec*, 1864.

Present or absent *Present*

Stoppage, \$ 100 for

Due Gov't, \$ 100 for

Valuation of horse, \$ 100

Valuation of horse equipments, \$ 100

Remarks:

.....
.....
.....
.....
.....
.....
.....
.....
.....

Book mark:

M Jackson
Copyist.

(358)

2 | 1 Cav. | U.S.C.T.

Godfrey Wyatt

Regt, Co. H, 1 Reg't U. S. Col'd Cavalry.

Appears on

Company Muster Roll

for *Jan & Feb*, 186 *5*.

Present or absent *Present*

Stoppage, \$ *100* for

Due Gov't, \$ *100* for

Valuation of horse, \$ *100*

Valuation of horse equipments, \$ *100*

Remarks:

Book mark:

(358)

M Jackson
Copyist.

24 | **1 Cav. | U.S.C.T.**

Godfrey Bryant
Bugler, Co. H, 1 Reg't U. S. Col'd Cavalry.

Appears on

Company Muster Roll

for *March - April*, 186*5*.

Present or absent *Present*

Stoppage, \$ *100* for

Due Gov't, \$ *0* ^{*30*}/_{*100*} for *Ordnance*

Valuation of horse, \$ *100*

Valuation of horse equipments, \$ *100*

Remarks: *For one (1)*
Sabre Shot

Book mark:

(358)

J. M. Jackson
Copyist.

21 | 1 Cav. | U.S.C.T.

Godfrey Thyer

Reg't Co. H, 1 Reg't U. S. Col'd Cavalry.

Appears on

Company Muster Roll

for May June, 1865.

Present or absent Present

Stoppage, \$ 100 for

Due Gov't, \$ 100 for

Valuation of horse, \$ 100

Valuation of horse equipments, \$ 100

Remarks: Due US for
and labor that 300

Book mark:

(358)

W M Jackson

Copyist.

24 | **1 Cav.** | **U.S.C.T.**

Godfrey Hyatt

Bugler, Co. H, 1 Reg't U. S. Col'd Cavalry.

Appears on

Company Muster Roll

for *July + Aug*, 186 *5*

Present or absent *Present*

Stoppage, \$ *100* for

Due Gov't, \$ *100* for

Valuation of horse, \$ *100*

Valuation of horse equipments, \$ *100*

Remarks: *Due US for*
Cur Sabre Knut 30¢

Book mark: *2000*

(358)

A. M. Jackson
Copyist.

W | 1 Cav. | U.S.C.T.

Godfrey Wyatt

Bugler, Co. H, 1 Reg't U. S. Col'd Cavalry.

Appears on

Company Muster Roll

for Sept & Oct, 1865.

Present or absent Present

Stoppage, \$ 100 for

Due Gov't, \$ 100 for

Valuation of horse, \$ 100

Valuation of horse equipments, \$ 100

Remarks:

Book mark:

J Stewart

(358)

Copyist.

W | 1 Cav. | U.S.C.T.

Godfrey Wyatt

Pt, Co. H, 1 Reg't U. S. Col'd Cavalry.

Appears on

Company Muster Roll

for Nov & Dec, 1865

Present or absent Present

Stoppage, \$ 100 for

Due Gov't, \$ 100 for

Valuation of horse, \$ 100

Valuation of horse equipments, \$ 100

Remarks: Relieved as Bugler
Dec 1, 1865

Book mark:

W Stewart

W | 1 Cav. | U.S.C.T.

Godfrey Wyatt

Buy
Mus, Co. A., 1 Reg't U. S. Colored Cav.
Pot.

Appears on Returns as follows:

May June 1863. on duty with
Regt Band

July 18 63 (Mus) on duty with
with Regt. Band

Aug to Dec 1863 (Pot) on duty
with Regt Band

Book mark :

Chas. Patton

W | **1 Cav.** | **U.S.C.T.**

Godfrey Wyatt
Pt *IX*, Co. *IX*, 1 Reg't U. S. Col'd Cavalry.

Appears on **Co. Muster-out Roll**, dated
Brazos Santiago Tex, Feb 4, 1866.

Muster-out to date _____, 186 .

Last paid to *Aug 31, 1865.*

Clothing account:

Last settled _____, 186 ; drawn since \$ _____ 100

Due soldier \$ *16* ^{*25*}/_{*100*}; due U. S. \$ _____ 100

Am't for cloth'g in kind or money adv'd \$ _____ 100

Due U. S. for arms, equipments, &c., \$ _____ 100

Bounty paid \$ _____ 100; due \$ _____ 100

Remarks: *Joined at org org*
was private until Dec 15/63
Bugler until Dec 1/65 no
discharge given

Book mark : _____

J. Stewart
 (361) Copyist.

N | *1st* *Law* | *U.S.A.*

Godfrey Wyatt
Pat., Co. *H*, *1st* Reg't *U.S.A.*

NOTATION.

Book mark: *N 57th Co. 5th 1874*

War Department,

Record and Pension Division,

Washington, *May 4th*, 18*92*.

It has this day (*May 4th*, 18*92*.)

been determined by this Department from evidence furnished by the Second Auditor of the Treasury that this man was mustered out with the company *1st*, 18*66*, and paid to include *Feb 25th*, 18*66*, date to which company was paid on discharge.

S. J. Mack

(464)

Appr.

1531 or Keymore
 Wynn Keymon
 Co A, 1 U. S. Col'd Cav.

Private Private

CARD NUMBERS.

1	5299314	26
2	5301262	27
3	5301349	28
4	5301435	29
5	5301521	30
6	5301608	31
7	5301704	32
8	5301817	33
9	5301922	34
10	5302032	35
11	5302409	36
12	9085-8281	37
13	40725526	38
14		39
15		40
16		41
17		42
18		43
19		44
20		45
21		46
22		47
23		48
24		49
25		50

Book Mark: V.183 P.260-74. PV32. P.
 F. 75.

See also

A | **1 Cav. | U.S.C.T.**

Keymore A. Myron
Plt, Co. *A*, 1 Reg't U.S. Col'd Cav.

Appears on

Company Descriptive Book

of the organization named above.

DESCRIPTION.

Age *27* years; height *5* feet *5 1/2* inches.

Complexion *Dark*

Eyes; *Black* hair *Black*

Where born *Jamestown Va*

Occupation *Farmer*

ENLISTMENT.

When *Jan 11 1864*

Where *Hampton Va*

By whom *Capt Hley*; term *3* y'rs.

Remarks: *Deserted from*
Steamer Meteor
while lying in
Hampton Roads
Va en route for
Texas June 13/65

Houston

W | 1 Cav. | U.S.C.T.

Keymore Wynn

Appears with rank of *2nd Lt* on

Muster and Descriptive Roll of a Detachment of U. S. Vols. forwarded

for the 1 Reg't U. S. Col'd Cavalry. Roll dated

Camp Mir Va. Jan 22, 1864.

Where born *Jamestown Va.*

Age *27* yrs; occupation *Farmer*

When enlisted *Jan 11, 1864.*

Where enlisted *Hampton Va*

For what period enlisted *3* years.

Eyes *Blk*; hair *Blk*

Complexion *Drk*; height *5 ft. 5 1/2 in.*

When mustered in _____, 186 .

Where mustered in _____

Bounty paid \$ 100; due \$ 100

Where credited _____

Company to which assigned _____

Remarks : _____

Book mark : _____

L.H. Harris

R | 1 Cav. | U.S.C.T.

Reynolds

R, Co. A, 1 Reg't U.S. Col'd Cavalry.

Appears on

Company Muster Roll

for *Jan, 4 Feb*, 1864.

Present or absent *Present*

Stoppage, \$ *100* for

Due Gov't, \$ *100* for

Valuation of horse, \$ *100*

Valuation of horse equipments, \$ *100*

Remarks: *Pay due from date of enlistment!*

(Mustered in Jan. 22, 64, at Ft. Monroe Va.)

Book mark:

O. J. Taylor

(358)

Copyist.

W

1 Cav. U.S.C.T.

Raymond Byam
Byam, Co. A, 1 Reg't U. S. Col'd Cavalry.

Appears on

Company Muster Roll

for *March & April*, 1864.

Present or absent *Present*

Stoppage, \$ 100 for

Due Gov't, \$ 100 for

Valuation of horse, \$ 100

Valuation of horse equipments, \$ 100

Remarks: *Due U. S. for Ordnance lost \$52.*

Book mark:

O. P. Taylor

(358)

Copyist.

W | **1 Cav.** | **U.S.C.T.**

Keymore Pyonre

Plt, Co. A, 1 Reg't U. S. Col'd Cavalry.

Appears on

Company Muster Roll

for *May & June*, 1864.

Present or absent *Present*

Stoppage, \$ *100* for

Due Gov't, \$ *100* for

Valuation of horse, \$ *100*

Valuation of horse equipments, \$ *100*

Remarks:

Book mark:

O. P. Taylor
Copyist.

W

1 Cav. U.S.C.T.

Keymore Nymon

ON, Co. A, 1 Reg't U. S. Col'd Cavalry.

Appears on

Company Muster Roll

for *July & Aug.*, 1864.

Present or absent *Absent*

Stoppage, \$ *100* for

Due Gov't, \$ *100* for

Valuation of horse, \$ *100*

Valuation of horse equipments, \$ *100*

Remarks: *Due U.S. for Ord-
nance loss \$3.43. Sick
in Genl. Hosptl. at Fort
Monroe, Va.*

Book mark:

O. J. Taylor

(358)

Copyist.

24 | 1 Cav. | U.S.C.T.

Raymond Wynn
Priv, Co. A, 1 Reg't U.S. Col'd Cavalry.

Appears on

Company Muster Roll

for Sept. & Oct., 1864.

Present or absent Present

Stoppage, \$ 100 for

Due Gov't, \$ 100 for

Valuation of horse, \$ 100

Valuation of horse equipments, \$ 100

Remarks: Due U.S. for
Ordinance Lost
\$343

Book mark:

Edwin

W | **1 Cav.** | **U.S.C.T.**

Kenneth Wynn

2d, Co. A, 1 Reg't U. S. Col'd Cavalry.

Appears on

Company Muster Roll

for *Nov & Dec*, 186*4*.

Present or absent *Present*

Stoppage, \$ 100 for

Due Gov't, \$ 100 for

Valuation of horse, \$ 100

Valuation of horse equipments, \$ 100

Remarks:

Book mark: -----

(358)

Johnson

Copyist.

W | **1 Cav.** | **U.S.C.T.**

Raymond Wynn

Priv., Co. A, 1 Reg't U. S. Col'd Cavalry.

Appears on

Company Muster Roll

for Jasny & Felby, 1865.

Present or absent Present

Stoppage, \$ 100 for

Due Gov't, \$ 100 for

Valuation of horse, \$ 100

Valuation of horse equipments, \$ 100

Remarks:

Book mark:

Tolman

24 | 1 Cav. | U.S.C.T.

Keymore Wynn
Pvt., Co. A, 1 Reg't U. S. Col'd Cavalry.

Appears on

Company Muster Roll

for March & April, 1865.

Present or absent Present

Stoppage, \$ 100 for

Due Gov't, \$ 100 for

Valuation of horse, \$ 100

Valuation of horse equipments, \$ 100

Remarks:
.....
.....
.....
.....
.....
.....
.....
.....

Book mark:

(358) Tobman Copyist.

W. X. | **1 Cav.** | **U.S.C.T.**

Wynn, Keymer
Priv., Co. A, 1 Reg't U. S. Col'd Cavalry.

Appears on

Company Muster Roll

for May & June, 1865.

Present or absent _____

Stoppage, \$ _____ 100 for _____

Due Gov't, \$ _____ 100 for _____

Valuation of horse, \$ _____ 100

Valuation of horse equipments, \$ _____ 100

Remarks: Deserted from
Steamer Meteor
June 13/65 at Hampton
Road, Va Due U.S.
Ordinance \$20.81 Camp
& Garrison \$11.40 Suttler
\$43.00

Book mark: _____

Thomas

(358)

Copyist.

W | 1 Cav. | U.S.C.T.

Raymore Wynn

Priv, Co. *A*, 1 Reg't U. S. Colored Cav.

Appears on Returns as follows:

*Aug 1864 absent sick in
Gent Hosp. Ft Monroe Va*

*June 1865 June 12/65. Fort
Monroe Va Deserted
from transport while lying
in Hampton Roads Va*

Book mark:

W. Wynn

H | *Car* | U.S.C.T.

Raymond Wynn

Privt, Co. A, 1 Reg't U. S. Col'd *Car*

Appears on **Co. Muster-out Roll**, dated

Brazos Santiago Tex, Feb, 1866.

Muster-out to date _____, 186 .

Last paid to *Dec 31*, 1864.

Clothing account:

Last settled _____, 186 ; drawn since \$ _____ 100

Due soldier \$ _____ 100 ; due U. S. \$ _____ 100

Am't for cloth'g in kind or money adv'd \$ _____ 100

Due U. S. for arms, equipments, &c., \$ *32 2/100*

Bounty paid \$ _____ 100 ; due \$ _____ 100

Remarks: *Joined as recruit*

Deserted at Fort Monroe

Va, June 13" 1865. Stopped

for one Remington Pistol and

holster, Sabre, Sabre Belt and

Plate, Cartg, and cap Box

Book mark: *V183, P260, 74*

D.P. Meteler

NARA 797

JAN. - 6

5302409

1891 *

Screw-driver and cone
wrench, one shelter tent,
canteen and Havers-
sack stolen.

PV 32, P. 8, 75

1532A
Gerby, Hiram
Co B, 1 U. S. Col'd Cav.

Private Private

CARD NUMBERS.

1	5303863	26
2	5303934	27
3	5304021	28
4	5304107	29
5	5314192	30
6	5300366	31
7	5304277	32
8	5304363	33
9	5304469	34
10	5304579	35
11	5304685	36
12	5304784	37
13	5304884	38
14	5304978	39
15	5305088	40
16	5305156	41
17	9086059	42
18	40725552	43
19		44
20		45
21		46
22		47
23		48
24		49
25		50

Book Mark

See also

G | 1 Cav. | U.S.C.T.

William Gerby
....., Co. *B*, 1 Reg't U.S. Col'd Cav.

Appears on

Company Descriptive Book

of the organization named above.

DESCRIPTION.

Age *24* years; height *5* feet *7* inches.

Complexion *Beach*

Eyes; *Beach* hair *Beach*

Where born *Birmingham*

Occupation *Laborer*

ENLISTMENT.

When *Dec 4/63*

Where *Norfolk Va*

By whom *Capt Brown*; term *3* y'rs.

Remarks:

.....
.....
.....
.....
.....
.....
.....
.....

Herrington

M. C. | *Car.* | **U.S.C.T.**

William Farley,
P. Co. C, | *1* Reg't U. S. Col'd *Car.*

Age *34* years.

Appears on

Company Muster-in Roll

of the organization named above. Roll dated

Ch. Hamilton, Va, *Dec. 22,* 1863.

Muster-in to date *Dec. 22,* 1863.

Joined for duty and enrolled:

When *Dec. 4*, 1863.

Where *Norfolk, Va*

Period *3* years.

Valuation of horse, \$ *100*

Valuation of horse equipments, \$ *100*

Remarks :

Book mark :

Hick

Y | **1 Cav.** | **U.S.C.T.**

William Yerby

Pat, Co. C, 1 Reg't U. S. Col'd Cavalry.

Appears on

Company Muster Roll

for Dec 22 to 31, 1863.

Present or absent Present

Stoppage, \$ 100 for

Due Gov't, \$ 100 for

Valuation of horse, \$ 100

Valuation of horse equipments, \$ 100

Remarks:

Book mark:

A. Kerman

(358)

Copyist.

G

1 Cav.

U.S.C.T.

Hiram Yerby

Pvt, Co. C, 1 Reg't U. S. Col'd Cavalry.

Appears on

Company Muster Roll

for *Jan'y + Feb*, 186*4*.

Present or absent *Present*

Stoppage, \$ *100* for

Due Gov't, \$ *100* for

Valuation of horse, \$ *100*

Valuation of horse equipments, \$ *100*

Remarks:

Book mark:

Adlerman

(358)

Copyist.

1 Cav. U.S.C.T.

Hiram Gerby

Plt, Co. C, 1 Reg't U. S. Col'd Cavalry.

Appears on

Company Muster Roll

for *Mar + Apr*, 1864.

Present or absent *Present*

Stoppage, \$ *100* for

Due Gov't, \$ *100* for

Valuation of horse, \$ *100*

Valuation of horse equipments, \$ *100*

Remarks:

Book mark:

Ackerman

G | 1 Cav. | U.S.C.T.

Hiram Yerby

Pst, Co. C, 1 Reg't U. S. Col'd Cavalry.

Appears on

Company Muster Roll

for *May + June*, 186*4*

Present or absent *Absent*

Stoppage, \$ *100* for

Due Gov't, \$ *100* for

Valuation of horse, \$ *100*

Valuation of horse equipments, \$ *100*

Remarks: *Absent on detached Service, Order from Hd Qrs, U.S.C. dated June 26/64*

Book mark:

Ackerman

(358)

Copyist.

Y | 1 Cav | U.S.C.T.

Hiram Yerby
Sgt, Co. , 1 Reg't U. S. Col'd Cavalry
Appears on a

Detachment Muster Roll

of the organization named above

for May & June , 1864

Station Battlefield Hosp near Petersburg Va

Present or absent Present

Stoppage, \$ 100 for

Due Gov't, \$ 100 for

Valuation of horse, \$ 100

Valuation of horse equipments, \$ 100

Remarks:

Book mark:

(344)

Hammer

Copyist.

Y | *160* | U.S.C.T

Miriam Yerby
Pvt, Co. C, 1st Reg't U. S. Col'd Cavalry

Appears on

Company Muster Roll

for *July & Aug*, 186*4*.

Present or absent *Present*

Stoppage, \$ *100* for

Due Gov't, \$ *100* for

Valuation of horse, \$ *100*

Valuation of horse equipments, \$ *100*

Remarks:

Book mark:

E. P. Mari

(358)

Compt.
Compr

Y | 1 Cav. | U.S.C.T.

Hiram Yeakley

Sgt, Co. C, 1 Reg't U. S. Col'd Cavalry.

Appears on

Company Muster Roll

for *Sept 4th 1864*, 186*4*.

Present or absent *Present*

Stoppage, \$ 100 for

Due Gov't, \$ 100 for

Valuation of horse, \$ 100

Valuation of horse equipments, \$ 100

Remarks:

Book mark:

J. McNamara

(358)

Copyist.

Y | 1 Cav. | U.S.C.T.

Miriam Yerby

Priv, Co. C, 1 Reg't U. S. Col'd Cavalry.

Appears on

Company Muster Roll

for *Nov. 2nd Dec.*, 186*1*.

Present or absent *Present*

Stoppage, \$ *100* for

Due Gov't, \$ *100* for

Valuation of horse, \$ *100*

Valuation of horse equipments, \$ *100*

Remarks:

Book mark:

(358) *J. McNamee* Copyist.

Y | 1 Cav. | U.S.C.T.

Hiram Yerby

Pvt, Co. C, 1 Reg't U. S. Col'd Cavalry.

Appears on

Company Muster Roll

for *Jan + Feb*, 186*5*.

Present or absent *Present*

Stoppage, \$ *100* for

Due Gov't, \$ *100* for

Valuation of horse, \$ *100*

Valuation of horse equipments, \$ *100*

Remarks: -----

Book mark: -----

J. M. Hance

(358) Copyist.

Y | 1 Cav. | U.S.C.T.

Heran Yerby

Pvt, Co. C, 1 Reg't U. S. Col'd Cavalry.

Appears on

Company Muster Roll

for Mar + Apr., 1865.

Present or absent Present

Stoppage, \$ 100 for

Due Gov't, \$ 100 for

Valuation of horse, \$ 100

Valuation of horse equipments, \$ 100

Remarks:

Book mark:

(358) J. McHance Copyist.

Y | 1 Cav. | U.S.C.T.

Hiram Yerby

Pvt, Co. C, 1 Reg't U. S. Col'd Cavalry.

Appears on

Company Muster Roll

for *May & June*, 1865.

Present or absent *Present*

Stoppage, \$ *100* for

Due Gov't, \$ *100* for

Valuation of horse, \$ *100*

Valuation of horse equipments, \$ *100*

Remarks:

Book mark:

(358)

J. M. Dancer

Copyist.

Y. | 1 Cav. | U.S.C.T.

Ivram Yerby

Pat, Co. C, 1 Reg't U. S. Col'd Cavalry.

Appears on

Company Muster Roll

for *July & Aug*, 1865.

Present or absent *Absent*

Stoppage, \$ *100* for

Due Gov't, \$ *100* for

Valuation of horse, \$ *100*

Valuation of horse equipments, \$ *100*

Remarks: *Post Hospital Brazos
Santiago since Aug. 14/65
Dues U.S. Camp + Garrison
Equipage, one Canteen
one Haversack \$ 0.90*

Book mark :

J. M. Hance

(358)

Copyist.

G

1 Cav. | U.S.C.T.

William Terby

Privt, Co. C, 1 Reg't U. S. Col'd Cavalry.

Appears on

Company Muster Roll

for *Sept & Oct*, 186*5*.

Present or absent *Absent.*

Stoppage, \$ *100* for

Due Gov't, \$ *100* for

Valuation of horse, \$ *100*

Valuation of horse equipments, \$ *100*

Remarks:

*In Post Hospit. Brazos
Santiago Tex.
Since Aug 14/65.*

Book mark:

Lummer

(358)

Copyist.

G

1 Cav. U.S.C.T.

Norman Yerby

Pvt., Co. C, 1 Reg't U. S. Col'd Cavalry.

Appears on

Company Muster Roll

for Nov & Dec, 1865.

Present or absent Present.

Stoppage, \$ 100 for

Due Gov't, \$ 45/100 for Ordnance

lost or destroyed.

Valuation of horse, \$ 100

Valuation of horse equipments, \$ 100

Remarks:

[Empty lines for remarks]

Book mark:

Currier

G | 1 Cav. | U.S.C.T.

Hermin Yerby
Paris, Co. *C*, 1 Reg't U. S. Col'd Cavalry.

Appears on Co. Muster-out Roll, dated
Beazo Santiago Tex, Feb 4, 186 *6*.
 Muster-out to date *Feb 4*, 186 *6*.
 Last paid to *Aug 31*, 186 *5*.

Clothing account:

Last settled....., 186 ; drawn since \$.....100
 Due soldier \$ *17*^{*81*}/100; due U. S. \$.....100
 Am't for cloth'g in kind or money adv'd \$.....100

Due U. S. for arms, equipments, &c., \$.....^{*45*}/100

Bounty paid \$ *None* 100; due \$ *None* 100

Remarks: *Joined at Org/Org,*
Stopped for Cartmire Cone
purchase + repair Cartmire Cone

Book mark :

James
 (361) Copyist.

4 | 1 Cav. - U.S.C.T.

Kenan Yerby

Priv, Co. *C*, 1 Reg't U. S. Colored Cav.

Appears on Returns as follows:

Aug 1865 absent Aug 14
In Post Hosp. Brazos. Santiago Texas

Ret'd Nov 1865 absent
In Post Hosp. at Brazos. Santiago Tex since Oct 27/65

Book mark:

W. D. Miller

1533
Yorks, William H

Co F, 1 U. S. Col'd Cav.

Personal papers herein.

Private

Private

CARD NUMBERS.

1	<i>5299888</i>	26
2	<i>5299897</i>	27
3	<i>5308661</i>	28
4	<i>5308769</i>	29
5	<i>5308875</i>	30
6	<i>5308978</i>	31
7	<i>5309084</i>	32
8	<i>5309177</i>	33
9	<i>5309272</i>	34
10	<i>9086353</i>	35
11	<i>40725560</i>	36
12		37
13		38
14		39
15		40
16		41
17		42
18		43
19		44
20		45
21		46
22		47
23		48
24		49
25		50

Book Mark: *P.M. 4. 3918 Aug 15/66 MRS.*

See also _____

7/10/16 Pgt. 16 May 116 2016

8833042. GAR.

A1845685 Pu. 2012

S-2019107 Prod 720. (elo)

R-2020611 avd

R4P706054

Thos. C. Hatch
Et.

Y. | 1 Cav. | U.S.C.T.

William Henry York.

....., Co. A, 1 Reg't U.S. Col'd Cav.

Appears on

Company Descriptive Book

of the organization named above.

DESCRIPTION.

Age 18 years; height 5 feet 4 inches.

Complexion Blk.

Eyes; Blk. hair Blk.

Where born Drenton N. J.

Occupation Waiter.

ENLISTMENT.

When Jan 9 - 1865.

Where Poughkeepsie N. Y.

By whom Capt Johnson, term 3 y'rs.

Remarks: Received \$100.

Bounty. Credited
to Amherst 12th
Cong Dist N. Y.

Dickerson.

Y *1600* U.S.C.T.
William H. Yorks

Appears with rank of *Pr* on

Muster and Descriptive Roll of a Detachment of U. S. Vols. forwarded

for the *1* Reg't U. S. Col'd *Co* Roll dated

Poughkeepsie NY Jan 12, 1865.

Where born *Newton Waiter*

Age *18* y'rs; occupation *waiter*

When enlisted *Jan 9*, 1865.

Where enlisted *Poughkeepsie City*

For what period enlisted *3* years.

Eyes *Black*, hair *Black*

Complexion *Black*; height *5 ft. 4* in.

When mustered in *Jan 9*, 1865.

Where mustered in *Poughkeepsie*

Bounty paid \$ *100* *100*; due \$ *100*

Where credited *12 Cong dist. Poughkeepsie City*

Company to which assigned

Remarks:

Book mark:

W. H. Yorks

C. W. York | **U.S.C.T.**

William H. York
Pr

Appears with rank of _____ on _____

Muster and Descriptive Roll of a Detachment of U. S. Vols. forwarded

for the *1* Reg't U. S. Col'd *Car* Roll dated *Hart Island NY, Jan 17, 1865.*

Where born *Newton N.J.*

Age *18* y'rs; occupation *Writer*

When enlisted *Jan 9*, 186*5*.

Where enlisted *Cokepsie*

For what period enlisted *3* years.

Eyes *Blk*; hair *Blk*

Complexion *Blk*; height *5* ft. *4* in.

When mustered in *Jan 9*, 186*5*.

Where mustered in *Cokepsie*

Bounty paid \$ *100* ¹⁰⁰; due \$ ¹⁰⁰

Where credited *12th English Cokepsie*

Company to which assigned _____

Remarks: _____

Book mark: _____

[Signature]

4

1 Cav. U.S.C.T.

William H. York

Priv, Co. F, 1 Reg't U. S. Col'd Cavalry.

Appears on

Company Muster Roll

for Jan & Feb, 1865.

Present or absent Present

Stoppage, \$ 100 for

Due Gov't, \$ 100 for

Valuation of horse, \$ 100

Valuation of horse equipments, \$ 100

Remarks: Pay due from date of enlistment

Book mark:

J. L. Leonard

(358)

Copyist.

4 | 1 Cav. | U.S.C.T.

William H York

Priv, Co. F, 1 Reg't U. S. Col'd Cavalry.

Appears on

Company Muster Roll

for Mar. & Apr, 1865.

Present or absent Present

Stoppage, \$ 100 for

Due Gov't, \$ 100 for

Valuation of horse, \$ 100

Valuation of horse equipments, \$ 100

Remarks:

Book mark:

J. W. Leonard

(358)

Copyist.

Y | 1 Cav. | U.S.C.T.

William H Yorks

Pvt., Co. F, 1 Reg't U. S. Col'd Cavalry.

Appears on

Company Muster Roll

for May & June, 1865.

Present or absent Present

Stoppage, \$ 100 for

Due Gov't, \$ 100 for

Valuation of horse, \$ 100

Valuation of horse equipments, \$ 100

Remarks:

Book mark:

A. L. Gernan

(358)

Copyist.

47 | 1 Cav. | U.S.C.T.

John S. York

M, Co. F, 1 Reg't U. S. Col'd Cavalry.

Appears on

Company Muster Roll

for July & Aug, 1865.

Present or absent absent

Stoppage, \$ 100 for

Due Gov't, \$ 100 for

Valuation of horse, \$ 100

Valuation of horse equipments, \$ 100

Remarks: In S. M. Dept. detached, service

Book mark:

J. W. [Signature]

(358)

Copyist.

W. H. Jones | 1 Cav. | U.S.C.T.

W. H. Jones
Priv, Co. F, 1 Reg't U. S. Col'd Cavalry.

Appears on

Company Muster Roll

for *Sept. & Oct.*, 1865.

Present or absent *Absent*

Stoppage, \$ *100* for

Due Gov't, \$ *100* for

Valuation of horse, \$ *100*

Valuation of horse equipments, \$ *100*

Remarks: *W. H. A. No. 64.*

Book mark:

B. J. Cook
Copyist.

G. | 1 Cav. | U.S.C.T.

Wm. H. York

Pvt, Co. F, 1 Reg't U. S. Col'd Cavalry.

Appears on

Company Muster Roll

for *Nov. and Dec.*, 1865.

Present or absent *Absent*

Stoppage, \$ 100 for

Due Gov't, \$ 100 for

Valuation of horse, \$ 100

Valuation of horse equipments, \$ 100

Remarks: *S. S. Spill Co. No. 64*
H'd Co 3^d Div. 25 A. C.

Book mark:

B. J. Cook

(358)

Copyist.

G | 1 Cav. | U.S.C.T.

D.M. Works

Pat, Co. *G*, 1 Reg't U. S. Colored Cav.

Appears on Returns as follows:

Aug 1863. *Ordinary Orderly*
Aug Post. Reg't Hdqrs

Sept 1863. *absent Opl. Ord*
No 67 + by Aug 19 + 22/63
D.M. Sept

Oct 10 - Dec 1863 *absent*
D.M. Sept. 30th by
Hdqrs. 25. a.c. Sept
10/63 Prazos

Book mark:

Chas. Patton

W. | **1 Cav. | U.S.C.T.**

William H. Goyne

Priv., Co. *F*, 1 Reg't U. S. Col'd Cavalry.

Appears on **Co. Muster-out Roll**, dated

Bravo, Santiago Tex, Feb. 4, 1866.

Muster-out to date *Feb. 4*, 1866.

Last paid to *Aug. 31*, 1865.

Clothing account:

Last settled....., 186 ; drawn since \$.....100

Due soldier \$ *10²⁸*.....100; due U. S. \$.....100

Am't for cloth'g in kind or money adv'd \$.....100

Due U. S. for arms, equipments, &c., \$.....100

Bounty paid \$ *100*.....100; due \$ *None*.....100

Remarks: *Joined as Recruit*

Book mark *Comp. 3918 May 15/66 MS.*

(361)

B. J. Cooke

Copyist.

Yorks, Wm A.
 _____, Co. _____, Reg't *1 S. 6. Cav.*

2 Enclosures.

Bed Cards	Final Statements
Burial Records	Furloughs or L. of A
Certs. of Dis. for Discharge	Med. Certificates
C. M. Charges	Med. Des. Lists
Descriptive Lists	Orders
Discharge Certificates	Pris. of War Record
Enlistment Papers <i>2</i>	Resignations

Other papers relating to—

Admission to Hosp'l	Furlough or L. of A
Casualty Sheet	Med. Examination
Confinement	Misc. Information
Contracts	Pay or Clothing
Death or Effects	Personal Reports
Desertion	Rank
Discharge from Hosp'l	Transfer to Hosp'l
Discharge from Service	Transfer to V. R. C.
Duty	Transportation
.....

DECLARATION OF RECRUIT.

I, William H. York, desiring to VOLUNTEER as a Soldier in the Army of the United States, for the term of Three YEAR; Do Declare, That I am Eighteen years and nine months of age; that I have never been discharged from the United States service on account of disability or by sentence of a court martial, or by order before the expiration of enlistment; and I know of no impediment to my serving honestly and faithfully as a soldier for five year's

GIVEN at the Pikeville he 9th day of Jan, 1866

Witness: C. V. Owen

No. 2388
Volunteered at Pikeville
By Wm. H. York, 1866
Regiment of W.D. Bates

Discharged _____, 186
Reg't of _____
enlistment; last served in Company ()

Not in regular army
1863
Colonel

CONSENT IN CASE OF MINOR.

I, _____ Do CERTIFY, That I am _____ the _____ of _____ that the said _____ is _____ years of age; and I do hereby freely give my CONSENT to his volunteering as a SOLDIER in the ARMY OF THE UNITED STATES for the period of _____ YEAR.

GIVEN at _____ the _____ day of _____

Witness: _____

(A. G. O. No. 74 & 76.)

NOTE 1.—This blank will be used for both enlistments and re-enlistments—enlistment of veterans, &c., &c., in the volunteer service. They will be made out in duplicate in all cases—one to accompany the recruiting return of the superintendent (not the recruiting officer) to the Adjutant General, and one to accompany the accounts of the office; who pays bounty, &c. The Regiment and Company in which the soldier last served should be given on the back.
NOTE 2.—An enlistment holds to service. A muster-in must, in all cases, precede payment of pay, bounty, pension, &c. A muster-in must, in all cases, be filed in the Adjutant General's Office as evidence of muster-in. The mustering officer, commissary, or assistant commissary of musters, as the case may be, will countersign both enlistments as having mustered the soldier into the service of the United States before either of them is given to the disbursing officer.

VOLUNTEER ENLISTMENT.

STATE OF NEW YORK.

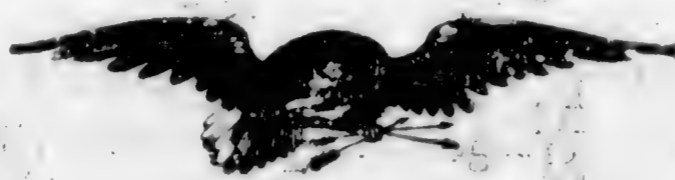

CITY OF ~~TOWN~~ OF *Pokepoc*

I, *William H. Yorks*, born in *Trouton* in the State of *New Jersey* aged *18* years and by occupation a *Waiter* do hereby acknowledge to have volunteered this *nineteenth* day of *January* 1865 to serve as a **SOLDIER** in the Army of the United States of America, for the period of *three* years and sooner discharged by proper authority: Do also agree to accept such bounty, pay, rations, and clothing, as are, or may be established by law for volunteers. And I, *William H. Yorks* do solemnly swear, that I will bear true faith and allegiance to the **United States of America**, and that I will serve them honestly and faithfully against all their enemies or opposers whomsoever; and that I will observe and obey the orders of the President of the United States, and the orders of the officers appointed over me, according to the Rules and Articles of War.

Sworn and subscribed to, at this *9th* day of *Jan.* 1865 BEFORE *Wm Johnston*

I CERTIFY, ON HONOR, That I have carefully examined the above named Volunteer, agreeably to the General Regulations of the Army, and that in my opinion, he is free from all bodily defects and mental infirmities, which would in any way disqualify him from performing the duties of a soldier.

Wm C Payne

EXAMINING SURGEON

I CERTIFY, ON HONOR That I have minutely inspected the Volunteer *W. H. Yorks* previously to his enlistment, and that he was entirely sober when enlisted; that, to the best of my judgment and belief, he is of lawful age, and that, in accepting him as duly qualified to perform the duties of an able-bodied soldier, I have strictly observed the Regulations which govern the recruiting service. This soldier has *black* eyes, *black* hair, *dark* complexion, is *5* feet *4* inches high.

Wm Johnston

Captain and Provost Marshal 9th Dist.

RECRUITING OFFICER

Lower Meriden
12th
and carried to City of
Put up 12th
Board
11th
9th
Carroll
1867
Pokepoc
Wm Johnston
Mustering Officer

DECLARATION OF RECRUIT.

I, *William D. Parks*, desiring to VOLUNTEER as a Soldier in the **Army of the United States**, for the term of *three* YEAR; Do Declare, That I am *18* years and *9* months of age; that I have never been discharged from the United States service on account of disability or by sentence of a court martial, or by order before the expiration of enlistment; and I know of no impediment to my serving honestly and faithfully as a soldier for *three* year.

GIVEN at the *City of Roxbury, Mass* he *9th* day of *January* 186*2*
Witness: *Wm. Heap* *William Heap*

No. *20388*
William D. Parks
Volunteered at *Roxbury, Mass.*
January 9th, 1862
By *Capt J. S. Johnston*
Regiment of *U. S. & C.*
enlistment; last served in Company ()
Reg't of
Discharged _____, 186*2*

CONSENT IN CASE OF MINOR.

I, _____ Do CERTIFY, That I am the _____ of _____; that the said _____ is _____ years of age; and I do hereby freely give my CONSENT to his volunteering as a SOLDIER in the ARMY OF THE UNITED STATES for the period of _____ YEAR.

GIVEN at _____ the _____ day of _____

Witness: _____

NOTE 1.—This blank will be used for both enlistments and re-enlistments—enlistment of veterans, &c., &c., in the volunteer service. They will be made out in duplicate in all cases—one to accompany the recruiting return of the superintendent (not the recruiting officer) to the Adjutant General, and one to accompany the accounts of the officer who pays bounty, &c. The Regiment and Company in which the soldier last served should be given on the back.
NOTE 2.—An enlistment holds to service. A muster-in must, in all cases, precede payment of pay, bounty, pension, &c. A muster-in must, in all cases, be filed in the Adjutant General's Office as evidence of muster-in. The mustering officer, commissary, or assistant commissary of musters, as the case may be, will countersign both enlistments as having mustered the soldier into the service of the United States before either of them is given to the disbursing officer.

500 PD

VOLUNTEER ENLISTMENT.

STATE OF NEW YORK.

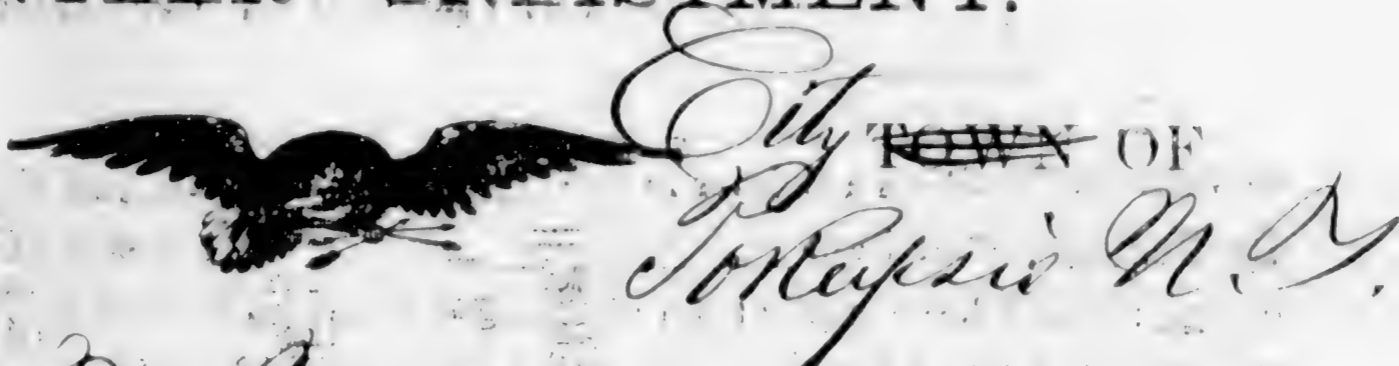

I, William H. York, born in Dutchess in the State of New Jersey aged 18 years, and by occupation a White Do hereby acknowledge to have volunteered this 9th day of January 1868 to serve as a SOLDIER in the Army of the United States of America, for the period of three YEARS unless sooner discharged by proper authority; Do also agree to accept such bounty, pay, rations, and clothing, as are, or may be, established by law for volunteers. And I, William H. York do solemnly swear, that I will bear true faith and allegiance to the United States of America, and that I will serve them honestly and faithfully against all their enemies or opposers whomsoever; and that I will observe and obey the orders of the President of the United States, and the orders of the officers appointed over me, according to the Rules and Articles of War

Sworn and subscribed to, at Poughkeepsie N.Y. this 9th day of January 1868 BEFORE me Wm H. York

I CERTIFY, ON HONOR, That I have carefully examined the above named Volunteer, agreeably to the General Regulations of the Army, and that, in my opinion, he is free from all bodily defects and mental infirmities, which would in any way disqualify him from performing the duties of a soldier.

Jos C Payne

EXAMINING SURGEON

I CERTIFY, ON HONOR, That I have minutely inspected the Volunteer William H. York previously to his enlistment, and that he was entirely sober when enlisted; that, to the best of my judgment and belief, he is of lawful age, and that, in respecting him, as duly qualified, to perform the duties of an able-bodied soldier, I have strictly observed the Regulations which govern the recruiting service. This soldier has Black eyes, Black hair, dark complexion, is 5 feet 4 inches high.

Wm H. York

Captain and Provost Marshal 1st Dist

RECRUITING OFFICER

(A. G. O. No. 74 & 75)

Vertical text on the right margin: Mustered into the service of the United States Army on the 9th day of January 1868 at Poughkeepsie N.Y. in the 12th Infantry, 1st Regt. Wm H. York

1334
Young Benjamin
Co E, 1 U. S. Col'd Cav.

Private Corporal

CARD NUMBERS.

1	5306624	26	-
2	5306897	27	
3	5306767	28	
4	5306841	29	
5	5308915	30	
6	5306986	31	
7	5307009	32	
8	5307094	33	
9	5307194	34	
10	5307298	35	
11	5307401	36	
12	5307559	37	
13	5307606	38	
14	5307695	39	
15	5307787	40	
16	9086232	41	
17		42	
18		43	
19		44	
20		45	
21		46	
22		47	
23		48	
24		49	
25		50	

Book Mark: V. J. P. 179. 68.

See also

Y. | 1 Cav. | U.S.C.T.

Benjamin Young.

....., Co. *E.*....., 1 Reg't U.S. Col'd Cav.

Appears on

Company Descriptive Book

of the organization named above.

DESCRIPTION.

Age *20* years; height *5* feet *3* inches.

Complexion *Yellow.*

Eyes; *Blk.* hair *Blk.*

Where born *Orlovlev, N.C.*

Occupation *Farmer.*

ENLISTMENT.

When *Dec 12 - 1863.*

Where *A C Monroe Va.*

By whom *N. C. Pond.*; term *3* y'rs.

Remarks:.....

.....

.....

.....

.....

.....

.....

.....

Dispersion.

9

1 Cav. | U.S.C.T.

Benjamin Young
Pvt, Co. E, 1 Reg't U. S. Col'd Cavalry.

Appears on

Company Muster Roll

for *Dec 21 to Dec 31*, 1863.

Joined for duty and enrolled:

When *Dec 12*, 1863.*

Where *Fort Monroe Va**

Period *3* years.*

Present or absent *Present*

Stoppage, \$ *100* for

Due Gov't, \$ *100* for

Valuation of horse, \$ *100*

Valuation of horse equipments, \$ *100*

Remarks:

* See enrollment on card from muster-in roll.

Book mark:

E. W. Moore

G 1 Cav. U.S.C.T.

Benjamin Young

Pi, Co. E, 1 Reg't U. S. Col'd Cavalry.

Age 20 years.

Appears on

Company Muster-in Roll

of the organization named above. Roll dated

Camp Hamilton Va, Dec 22, 1863.

Muster-in to date Dec 22, 1863.

Joined for duty and enrolled:

When Dec 12, 1863.*

Where Fort Monroe Va*

Period 3 years.*

Valuation of horse, \$ 100

Valuation of horse equipments, \$ 100

Remarks:

*Muster-in roll shows enrollment of all men of this company as of same date and place. See enrollment on subsequent card or cards.

Book mark:

O. H. Moore

4 | **1 Cav.** | **U.S.C.T.**

Benjamin Young
Co. E, Co. E, 1 Reg't U. S. Col'd Cavalry.

Appears on

Company Muster Roll

for *Jan & Feb*, 1864.

Joined for duty and enrolled :

When *Dec 12*, 1863.*

Where *Fort Monroe Va* *

Period *3* years.*

Present or absent *Present*

Stoppage, \$ *100* for

Due Gov't, \$ *100* for

Valuation of horse, \$ *100*

Valuation of horse equipments, \$ *100*

Remarks :

* See enrollment on card from muster-in roll.

Book mark : _____

[Signature]

6 | **1 Cav.** | **U.S.C.T.**

William Henry
Smith, Co. E, 1 Reg't U. S. Col'd Cavalry.

Appears on

Company Muster Roll

for March & April, 1864.

Joined for duty and enrolled :

When _____, 1864 .*

Where St Louis Mo *

Period 3 years.*

Present or absent Present

Stoppage, \$ _____ 100 for _____

Due Gov't, \$ _____ 100 for _____

Valuation of horse, \$ _____ 100

Valuation of horse equipments, \$ _____ 100

Remarks : _____

* ~~See~~ See enrollment on card from muster-in roll.

Book mark : _____

W. H. Smith

(358c)

Copyist.

1 Cav. U.S.C.T.

Benjamin Young
Co. E, 1 Reg't U. S. Col'd Cavalry.

Appears on

Company Muster Roll

for *May 11*, 1864.

Joined for duty and enrolled:

When *Dec 12*, 1863.*

Where *Fort Monroe Va**

Period *0* years.*

Present or absent *Present*

Stoppage, \$ *100* for

Due Gov't, \$ *100* for

Valuation of horse, \$ *100*

Valuation of horse equipments, \$ *100*

Remarks:

* See enrollment on card from muster-in roll.

Book mark:

Benjamin Young

4 | **1 Cav.** | **U.S.C.T.**

Benjamin Young
No., Co. E, 1 Reg't U. S. Col'd Cavalry.

Appears on

Company Muster Roll

for *July & Aug*, 186*7*.

Joined for duty and enrolled :

When *Dec 12*, 186*7*.*

Where *St Louis Mo* *

Period *3* years.*

Present or absent *Present*

Stoppage, \$ 100 for

Due Gov't, \$ 100 for

Valuation of horse, \$ 100

Valuation of horse equipments, \$ 100

Remarks :

* ~~See~~ See enrollment on card from muster-in roll.

Book mark :

C. H. Moore

Y | **1 Cav. | U.S.C.T.**

Benjamin Young
Capt., Co. E, 1 Reg't U. S. Col'd Cavalry.

Appears on

Company Muster Roll

for *Sept. & Oct.*, 1864.

Joined for duty and enrolled:

When *Dec. 12*, 1863.*

Where *Fort Monroe Va.* *

Period *3* years.*

Present or absent *Present.*

Stoppage, \$ *100* for

Due Gov't, \$ *1*^{*18*} *100* for *Ordinance*

Valuation of horse, \$ *100*

Valuation of horse equipments, \$ *100*

Remarks: *Promoted Capt*
Sept. 1/64

* See enrollment on card from muster-in roll.

Book mark:

(358c)

Wagner
 Copyist.

Y. | **1 Cav. | U.S.C.T.**
Benjamin Young
Co. E, 1 Reg't U. S. Col'd Cavalry.

Appears on

Company Muster Roll

for *Nov. & Dec.*, 186*4*.

Joined for duty and enrolled :

When *Dec. 12*, 186*3*.*

Where *St. Maurice, Va.* *

Period *3* years.*

Present or absent *Present.*

Stoppage, \$ *100* for

Due Gov't, \$ *1* ^{*18*}/_{*100*} for *Outrigger*

Valuation of horse, \$ *100*

Valuation of horse equipments, \$ *100*

Remarks: *Adopted Corp'l Sept. 1/64.*

* See enrollment on card from muster-in roll.

Book mark :

M. A. Green

1 Cav. U.S.C.T.

W. J. Young
Cpl., Co. E, 1 Reg't U. S. Col'd Cavalry.

Appears on

Company Muster Roll

for *Jan. & Feb.*, 186*5*.

Joined for duty and enrolled :

When *Dec. 14*, 186*5*.*

Where *St. Morris, Pa.* *

Period *3* years.*

Present or absent *Present*

Stoppage, \$ *100* for

Due Gov't, \$ *100* for

Valuation of horse, \$ *100*

Valuation of horse equipments, \$ *100*

Remarks:

* See enrollment on card from muster-in roll.

Book mark :

W. J. Young

Y. | **1 Cav.** | **U.S.C.T.**

Desj. Young
Corpl, Co. E, 1 Reg't U. S. Col'd Cavalry.

Appears on

Company Muster Roll

for *Mar 7 Apl.*, 1865.

Joined for duty and enrolled :

When *Dec. 12*, 1863.*

Where *H. Monroe* *

Period *3* years.*

Present or absent *Present.*

Stoppage, \$ *100* for

Due Gov't, \$ *100* for

Valuation of horse, \$ *100*

Valuation of horse equipments, \$ *100*

Remarks:

* See enrollment on card from muster-in roll.

Book mark : -----

Wagner
 (358c) Copyist.

Y. | **1 Cav.** | **U.S.C.T.**

Benj. Young
Corpl., Co. E, 1 Reg't U. S. Col'd Cavalry.

Appears on

Company Muster Roll

for *May & June*, 186*5*.

Joined for duty and enrolled :

When *Dec. 12*, 186*5*.*

Where *Ft. Monroe*.*

Period *3* years.*

Present or absent *Present*.

Stoppage, \$ *100* for

Due Gov't, \$ *100* for

Valuation of horse, \$ *100*

Valuation of horse equipments, \$ *100*

Remarks:

* See enrollment on card from muster-in roll.

Book mark:

(358c)

W. A. ...
 Copyist.

Y. | **1 Cav.** | **U.S.C.T.**

Benjamin Young
Buyle, Co. E, 1 Reg't U. S. Col'd Cavalry.

Appears on

Company Muster Roll

for July & Aug., 1865.

Joined for duty and enrolled:

When Dec. 3, 1863.*

Where Fl. Manassas, Va.*

Period 3 years.*

Present or absent Present.

Stoppage, \$ 100 for

Due Gov't, \$ 100 for

Valuation of horse, \$ 100

Valuation of horse equipments, \$ 100

Remarks: Reduced from Corporal
July 1, 1865. Due for ord
nance \$5.42

* See enrollment on card from muster-in roll.

Book mark :

Asst.
 Copyist.

Y | **1 Cav.** | **U.S.C.T.**

Benjamin Young
 Bugler, Co. E, 1 Reg't U. S. Col'd Cavalry.

Appears on

Company Muster Roll

for Sept + Oct, 1865.

Joined for duty and enrolled :

When Dec 12, 1863.*

Where Det Monroe *

Period 3 years.*

Present or absent Present

Stoppage, \$ 100 for

Due Gov't, \$ 100 for

Valuation of horse, \$ 100

Valuation of horse equipments, \$ 100

Remarks :

* See enrollment on card from muster-in roll.

Book mark :

A. H. Allen

2 1 Cav. U.S.C.T.

Benjamin Young
Capt., Co. E, 1 Reg't U. S. Col'd Cavalry.

Appears on

Company Muster Roll

for *Nov & Dec*, 186*5*.

Joined for duty and enrolled:

When *Dec 12*, 186*3*.*

Where *H. Monroe, Va.* *

Period *3* years.*

Present or absent *Present*

Stoppage, \$ *100* for

Due Gov't, \$ *100* for

Valuation of horse, \$ *100*

Valuation of horse equipments, \$ *100*

Remarks: _____

* See enrollment on card from muster-in roll.

Book mark: _____

Allen

Y 1 Cav | **U. S. C. T.**

Benjamin Young
Cap, Co. E, 1 Reg't U. S. Col'd Cavalry

Appears on **Co. Muster-out Roll**, dated

Brazos Santiago Texas, Feb 4, 186*6*.

Muster-out to date *Feb 4*, 186*6*.

Last paid to *Aug 31*, 186*5*.

Clothing account:

Last settled _____, 186 ____; drawn since \$ _____ ¹⁰⁰

Due soldier \$ _____ ¹⁰⁰; due U. S. \$ *4 71* ¹⁰⁰

Am't for cloth'g in kind or money adv'd \$ _____ ¹⁰⁰

Due U. S. for arms, equipments, &c., \$ _____ ¹⁰⁰

Bounty paid \$ *None* ¹⁰⁰ due \$ *None* ¹⁰⁰

Remarks: *Joined at Orgl org.*
Was Pvt until Sept 4/64,
then Corp until July 1/65,
then Bugler until Dec 17/65,
Discharge given at Brazos
Santiago Tex Feb 4/66 with a
view to final payment with
Lucas

~~Book mark:~~ _____

W. W. Allen

(361)

Copyist.

NARA 852

JAN. - 6

5307787

1891

out returning to the state
two copies pay rolls
furnished to O M to
facilitate payment.
Book-mark, v 7, P 179. 68.

1535

Young Cyrus
 Co E, 1 U.S. Col'd Cav.

Private Private

CARD NUMBERS.

1	5306631	26
2	5306698	27
3	5306768	28
4	5306842	29
5	5306916	30
6	5306987	31
7	5307078	32
8	5307178	33
9	5307278	34
10	5307384	35
11	5307482	36
12	5307578	37
13	5307673	38
14	5307761	39
15	5307853	40
16	9086233	41
17	4072553	42
18		43
19		44
20		45
21		46
22		47
23		48
24		49
25		50

Book Mark: V.116. P.253. 70.

See also

Y. | **1 Cav. | U.S.C.T.**

Cyrus Young,

....., Co. *E.*, 1 Reg't U.S. Col'd Cav.

Appears on

Company Descriptive Book

of the organization named above.

DESCRIPTION.

Age *35* years; height *5* feet *8* inches.

Complexion *Blk.*

Eyes; *Blk.* hair *Blk.*

Where born *Norfolk, Va.*

Occupation *Farmer.*

ENLISTMENT.

When *Dec 12 - 1863*

Where *At Monroe, Va.*

By whom *H. P. Pond.*; term *3* y'rs.

Remarks:

.....

Dickerson

G 1 Cav. | U.S.C.T.

Cyrus Young
Pri, Co. E, 4 Reg't U. S. Col'd Cavalry.

Age *35* years.

Appears on

Company Muster-in Roll

of the organization named above. Roll dated
Camp Hamilton Va, Dec 22, 1863.

Muster-in to date *Dec 22, 1863.*

Joined for duty and enrolled:

When *Dec 12, 1863.**

Where *Camp Hamilton Va.**

Period *1* years.*

Valuation of horse, \$ 100

Valuation of horse equipments, \$ 100

Remarks :

* Muster-in roll shows enrollment of all men of this company as of same date and place. See enrollment on subsequent card or cards.

Book mark :

D. M. Moore

G | **1 Cav.** | **U.S.C.T.**

Cyrus Young
Bil, Co. E, 1 Reg't U. S. Col'd Cavalry.

Appears on

Company Muster Roll

for *Dec 22 to Dec 31*, 186*7*.

Joined for duty and enrolled :

When *Dec 12*, 186*7*.*

Where *Fort Monroe Va**

Period *3* years.*

Present or absent *Present*

Stoppage, \$ *100* for

Due Gov't, \$ *100* for

Valuation of horse, \$ *100*

Valuation of horse equipments, \$ *100*

Remarks:

* See enrollment on card from muster-in roll.

Book mark:

D. W. ...

(358c)

Copyist.

Y | **1 Cav.** | **U.S.C.T.**

Cyrus Young
Co, Co. E, 1 Reg't U. S. Col'd Cavalry.

Appears on

Company Muster Roll

for Jan & Feb, 1867.

Joined for duty and enrolled :

When Dec 12, 1867.*

Where Fort Monroe Va *

Period 3 years.*

Present or absent Present

Stoppage, \$ 100 for

Due Gov't, \$ 100 for

Valuation of horse, \$ 100

Valuation of horse equipments, \$ 100

Remarks: _____

* ~~See~~ See enrollment on card from muster-in roll.

Book mark: _____

William

4 | **1 Cav.** | **U.S.C.T.**

James Young
RE, Co. E, 1 Reg't U. S. Col'd Cavalry.

Appears on

Company Muster Roll

for March & Apr, 1864.

Joined for duty and enrolled:

When _____, 1864.*

Where St. Louis, Mo.*

Period 3 years.*

Present or absent Present

Stoppage, \$ _____ 100 for _____

Due Gov't, \$ _____ 100 for _____

Valuation of horse, \$ _____ 100

Valuation of horse equipments, \$ _____ 100

Remarks: _____

* ~~See~~ See enrollment on card from muster-in roll.

Book mark: _____

James Young

1 Cav. U.S.C.T.

James Young
Pvt., Co. E, 1 Reg't U. S. Col'd Cavalry.

Appears on

Company Muster Roll

for May 1st 1864.

Joined for duty and enrolled :

When Dec 11, 1863.*

Where El Monroe Va.*

Period 3 years.*

Present or absent Present

Stoppage, \$ 100 for

Due Gov't, \$ 100 for

Valuation of horse, \$ 100

Valuation of horse equipments, \$ 100

Remarks:

* See enrollment on card from muster-in roll.

Book mark:

J. Monroe

1 Cav. U.S.C.T.

Thomas Young

Co. E, Co. E, 1 Reg't U. S. Col'd Cavalry.

Appears on

Company Muster Roll

for *July & Aug*, 1864.

Joined for duty and enrolled:

When *Dec 12*, 1863.*

Where *At Monroe Va* *

Period *2* years.*

Present or absent *Present*

Stoppage, \$ *100* for

Due Gov't, \$ *100* for

Valuation of horse, \$ *100*

Valuation of horse equipments, \$ *100*

Remarks:

* See enrollment on card from muster-in roll.

Book mark:

E. M. Moore

Y. | **1 Cav.** | **U.S.C.T.**

Cyrus Young

Priv., Co. E, 1 Reg't U. S. Col'd Cavalry.

Appears on

Company Muster Roll

for *Sept. & Oct.*, 186*4*.

Joined for duty and enrolled :

When *Dec. 12*, 186*3*.*

Where *Ft. Monroe, Va.**

Period *3* years.*

Present or absent *Present.*

Stoppage, \$ *100* for

Due Gov't, \$ *100* for

Valuation of horse, \$ *100*

Valuation of horse equipments, \$ *100*

Remarks:

* See enrollment on card from muster-in roll.

Book mark :

Wagner

1 Cav. U.S.C.T.

17
Cyrus Young
Opt., Co. E, 1 Reg't U.S. Col'd Cavalry.

Appears on

Company Muster Roll

for *Nov 7 Dec*, 1864.

Joined for duty and enrolled :

When *Dec. 12*, 1863.*

Where *St. Louis, Mo.* *

Period *3* years.*

Present or absent *Present*

Stoppage, \$ *100* for

Due Gov't, \$ *100* for

Valuation of horse, \$ *100*

Valuation of horse equipments, \$ *100*

Remarks:

* See enrollment on card from muster-in roll.

Book mark:

(358c)

Cyrus Young

Copyist.

Y. | 1 Cav. | U.S.C.T.

Cyrus Young
Co. E, 1 Reg't U. S. Col'd Cavalry.

Appears on

Company Muster Roll

for *Jan 7 Feb, 1863.*

Joined for duty and enrolled :

When *Dec. 12, 1863.**

Where *Lt. Monroe Va. **

Period *3* years.*

Present or absent *Present.*

Stoppage, \$ *100* for

Due Gov't, \$ *100* for

Valuation of horse, \$ *100*

Valuation of horse equipments, \$ *100*

Remarks:
.....
.....
.....

* See enrollment on card from muster-in roll.

Book mark :
.....

Wagner

(358c)

Copyist.

24 | **1 Cav. | U.S.C.T.**

Cyrus Young
Pr., Co. E, 1 Reg't U. S. Col'd Cavalry.

Appears on

Company Muster Roll

for *May & Apl.*, 1865.

Joined for duty and enrolled :

When *Dec. 12*, 1863.*

Where *St. Maurice* *

Period *3* years.*

Present or absent *Present.*

Stoppage, \$ *100* for

Due Gov't, \$ *100* for

Valuation of horse, \$ *100*

Valuation of horse equipments, \$ *100*

Remarks: _____

Filed with Cyrus Young.

* ~~43~~ See enrollment on card from muster-in roll.

Book mark: _____

(358c)

Wagner

Copyist.

4 | **1 Cav.** | **U.S.C.T.**

Cyrus Young
Part., Co. E, 1 Reg't U. S. Col'd Cavalry.

Appears on

Company Muster Roll

for *May & June*, 1865.*

Joined for duty and enrolled:

When *Dec. 12*, 1863.*

Where *Ft. Monroe*.*

Period *3* years.*

Present or absent *Present*.

Stoppage, \$ *100* for

Due Gov't, \$ *100* for

Valuation of horse, \$ *100*

Valuation of horse equipments, \$ *100*

Remarks:

* See enrollment on card from muster-in roll.

Book mark:

C. S. W.
 Copyist.

Y. | **1 Cav.** | **U.S.C.T.**

* *Cyrus Young*
Pat., Co. E, 1 Reg't U. S. Col'd Cavalry.

Appears on

Company Muster Roll

for *July 7 Aug.*, 186*6*.*

Joined for duty and enrolled :

When *Dec. 12*, 186*6*.*

Where *Ft. Monroe*, *

Period *3* years.*

Present or absent *Present*.

Stoppage, \$ *100* for

Due Gov't, \$ *100* for

Valuation of horse, \$ *100*

Valuation of horse equipments, \$ *100*

Remarks: *Due for ordnance*
\$ 2.0.

* Borne under "Present" as
"Edward Young."

* See enrollment on card from muster-in roll.

Book mark : _____

(358c)

W. H.
 Copyist.

My

1 Cav. U.S.C.T.

Cyrus Young

Priv., Co. E, 1 Reg't U. S. Col'd Cavalry.

Appears on

Company Muster Roll

for *Sept* * *Oct*, 186*5*.

Joined for duty and enrolled:

When *Dec 12*, 186*3*.*

Where *St. Maurice* *

Period *3* years.*

Present or absent *Absent*

Stoppage, \$ *100* for

Due Gov't, \$ *100* for

Valuation of horse, \$ *100*

Valuation of horse equipments, \$ *100*

Remarks: *On D. Seat Norfolk, Va*

* See enrollment on card from muster-in roll.

Book mark :

A. W. Allen

(358c)

Copyist.

3 | **1 Cav.** | **U.S.C.T.**

Cyrus Young
Priv., Co. E, 1 Reg't U. S. Col'd Cavalry.

Appears on

Company Muster Roll

for *Nov + Dec*, 186*5*.

Joined for duty and enrolled :

When *Dec 12*, 186*5*.*

Where *St Monroe* *

Period *3* years.*

Present or absent *Absent*

Stoppage, \$ *100* for

Due Gov't, \$ *100* for

Valuation of horse, \$ *100*

Valuation of horse equipments, \$ *100*

Remarks: *Dis at St Monroe, Va.*

* See enrollment on card from muster-in roll.

Book mark :

A W Allen

Y | 1 Cav. | U.S.C.T.

Cyrus Young

Priv, Co. *E*, 1 Reg't U. S. Colored Cav.

Appears on Returns as follows:

Oct 18 65 *Company 1866. absent*
on D. Hart Monroe
Va since Oct 5/65

Book mark:

Chas. Patton

(546)

Copyist.

71 / Car | U.S.C.T.

Cyrus Young
Pia, Co. E, / Reg't U. S. Col'd Car

Appears on **Co. Muster-out Roll**, dated
Brazos Santiago Texas, Feb 4, 1866.

Muster-out to date *Feb 4, 1866.*

Last paid to *Aug 31, 1865.*

Clothing account:

Last settled _____, 186 ; drawn since \$ _____ 100

Due soldier \$ *17*^{*01*}/₁₀₀; due U. S. \$ _____ 100

Am't for cloth'g in kind or money adv'd \$ _____ 100

Due U. S. for arms, equipments, &c., \$ _____ 100

Bounty paid \$ *none* 100; due \$ *none* 100

Remarks: *Joined at orgl org.*

Book mark: *VII 6, P 253, 70.*

Scott Allen

(361)

Copyist.

536
 Young, Daniel

Co L, 1 U. S. Col'd Cav.

Private

Private

CARD NUMBERS.

1	5299985	26
2	5299961	27
3	5314823	28
4	5314885	29
5	5314959	30
6	5315019	31
7	5315080	32
8	5315136	33
9	9087019	34
10	40725554	35
11		36
12		37
13		38
14		39
15		40
16		41
17		42
18		43
19		44
20		45
21		46
22		47
23		48
24		49
25		50

Book Mark: 412.318.

See also

Y | *1 Cav.* | **U.S.C.T**

Daniel Young

Appears with rank of *Priv* on

Muster and Descriptive Roll of a Detachment of Drafted Men and Substitutes forwarded

for the *1* Reg't U.S. Col'd *Cav.* Roll dated *Hart Island N.Y.H., Feb. 28, 1865*

Where born *England*

Age *23* years; occupation *Farmer*

Drafted and mustered in:

When *March 8*, 1865.

Where *Brooklyn*

Period *3* years.

Eyes *Blk.*; hair *Blk.*

Complexion *Blk.*; height *5 ft. 5 3/4 in.*

Paid bounty and advance pay, \$ *100*

Bounty due \$ *100*

Where credited *Comp. Dist. 3*
Sub. Dist. Brooklyn

Company to which assigned

Remarks: *Substitute for*
Arthur G. Seymour

Book mark:

(340)

Easterling

Copyist.

G | *1 Cav* | **U.S.C.T**

David Young

Appears with rank of *Priv.* on

Muster and Descriptive Roll of a Detachment of Drafted Men and Substitutes forwarded

for the *1* Reg't U.S. Col'd *Cav.* Roll dated *Heart Island, N.Y.H., Feb. 28,* 186*5*

Where born *England*

Age *23* years; occupation *Farmer*

Drafted and mustered in:

When *March 8*, 186*5*.

Where *Brooklyn*

Period *3* years.

Eyes *Blue*; hair *Blue*

Complexion *Black*; height *5 ft. 5 1/2 in.*

Paid bounty and advance pay, \$ *100*

Bounty due \$ *100*

Where credited *3^d Regt. Dist.*

Company to which assigned

Remarks: *Sub. Dist Brooklyn. Substitute for Arthur A. Seymour.*

Book mark:

E. A. ...

G | 1 Cav. | U.S.C.T.

Daniel Young
Pl Co. L, 1 Reg't U. S. Col'd Cavalry.

Age _____ years.

Appears on

Company Muster Roll*

for *from Enlistment, to April 3, 1865*

Joined for duty and enrolled:

When _____, 186 .

Where _____

Period *3* years.

Mustered in:

When *Mch. 8*, 186 *5*.

Where *Brooklyn N.Y.*

Present or absent *Present*

Stoppage, \$ *100* for _____

Due Gov't, \$ *100* for _____

Valuation of horse, \$ *100*

Valuation of horse equipments, \$ *100*

Remarks: *Substitute*

* First current roll. No muster-in roll of this company on file.

Book mark : _____

(3586)

Ref

Copyist.

G | 1 Cav. | U.S.C.T.

Ward Young

Pat, Co. L, 1 Reg't U.S. Col'd Cavalry.

Appears on

Company Muster Roll

for May & June, 1865

Present or absent Present

Stoppage, \$ 100 for

Due Gov't, \$ 100 for

Valuation of horse, \$ 100

Valuation of horse equipments, \$ 100

Remarks:

Book mark:

(358)

Reif

Copyist.

G | 1 Cav. | U.S.C.T.

Wm. Young

Plt, Co. L, 1 Reg't U. S. Col'd Cavalry.

Appears on

Company Muster Roll

for July & Aug., 1865.

Present or absent Present

Stoppage, \$ 100 for

Due Gov't, \$ 100 for

Valuation of horse, \$ 100

Valuation of horse equipments, \$ 100

Remarks:

Book mark:

(358)

C. R. [Signature] Copyist.

G | 1 Cav. | U.S.C.T.

Manuel Young

Priv., Co. L, 1 Reg't U. S. Col'd Cavalry.

Appears on

Company Muster Roll

for Sept. & Oct., 1865.

Present or absent Present

Stoppage, \$100 for

Due Gov't, \$100 for

Valuation of horse, \$100

Valuation of horse equipments, \$100

Remarks:

Book mark:

(358)

Reif Copyist.

(Y) | 1 Cav. | U.S.C.T.

Daniel Young

Plt, Co. L, 1 Reg't U. S. Col'd Cavalry.

Appears on

Company Muster Roll

for Nov. 1st Dec, 1865.

Present or absent Present

Stoppage, \$ 100 for

Due Gov't, \$ 100 for

Valuation of horse, \$ 100

Valuation of horse equipments, \$ 100

Remarks:

Book mark:

(358)

[Signature]

Copyist.

Y. | 1 Cav. | U.S.C.T.

Law Young

Pr, Co *L*, 1 Reg't U. S. Colored Cav.

Appears on Returns as follows:

Oct. 1863 *Co* *Cook*

Book mark :

Chas. E. Allen

(546)

Copyist.

G | 1 Cav. | U.S.C.T.

Daniel Young

Plt, Co. L, 1 Reg't U. S. Col'd Cavalry.

Appears on Co. Muster-out Roll, dated

Brazos Santiago Tex Feb. 4, 1866.

Muster-out to date Feb. 4, 1866.

Last paid to Aug. 31, 1865.

Clothing account:

Last settled, 186 ; drawn since \$ 109

Due soldier \$ 100; due U. S. \$ 26 52 100

Am't for cloth'g in kind or money adv'd \$ 100

Due U. S. for arms, equipments, &c., \$ 100

Bounty paid \$ None 100; due \$ None 100

Remarks: Joined as Rec't

Book mark: 412.318

(361)

Reif

Copyist.

1537

Young Edward
 Co E, 1 U. S. Col'd Cav.

Recruit

Private

CARD NUMBERS.

1	5249843	26
2	5249763	27
3	5307177	28
4	5307277	29
5	5307383	30
6	5307481	31
7	5307579	32
8	5307674	33
9	5307760	34
10	5307854	35
11	9086279	36
12	4072555	37
13		38
14		39
15		40
16		41
17		42
18		43
19		44
20		45
21		46
22		47
23		48
24		49
25		50

Book Mark:

See also

Y. | **1 Cav. | U.S.C.T.**

Edward Young.

 , Co. *E.*, 1 Reg't U.S. Col'd Cav.

Appears on
Company Descriptive Book
 of the organization named above.

DESCRIPTION.

Age *23* years ; height *5* feet *7* inches.
 Complexion *Blk.*
 Eyes ; *Blk.* hair *Blk.*
 Where born *Sussex Co., Va.*
 Occupation *Farmer.*

ENLISTMENT.

When *Dec 3/64*
 Where *Newport News*
 By whom *Lt Monroe* ; term *3* y'rs.

Remarks:

Dickerson.

Yd / Car U.S.C.T.

Edward Young
Rec't

Appears with rank of _____ on

Muster and Descriptive Roll of a Detachment of U. S. Vols. forwarded

for the *1* Reg't U. S. Col'd *Car* Roll dated

Newport News Va Dec 31, 1864.

Where born *Surrey Co Va*

Age *23* y'rs; occupation *laborer*

When enlisted *Dec 3, 1864.*

Where enlisted *Newport News*

For what period enlisted *3* years.

Eyes *blk*; hair *blk*

Complexion *blk*; height *5 ft. 6 in.*

When mustered in *Dec 3, 1864.*

Where mustered in *Newport News*

Bounty paid \$ *100*; due \$ *100*

Where credited *Massachusetts 1st dish*

Company to which assigned *Unattached recruit*

Remarks: _____

Book mark: _____

[Signature]

Y | **1 Cav. U.S.C.T.**
Edward Young

Appears with rank of *Rec't* on

Muster and Descriptive Roll of a Detachment of U. S. Vols. forwarded

for the 1 Reg't U. S. Col'd Cavalry. Roll dated *Newport News Va dec 31, 1864.*

Where born *Surry Co Va*

Age *23* yrs; occupation *labourer*

When enlisted *Dec 3, 1864*

Where enlisted *Newport News*

For what period enlisted *3* years.

Eyes *blk*; hair *blk*

Complexion *dark*; height *56* ft. in.

When mustered in *Dec 3, 1864*

Where mustered in *Newport News*

Bounty paid \$ *100* ¹⁰⁰; due \$ ¹⁰⁰

Where credited *Massachusetts 1st dist*

Company to which assigned _____

Remarks : _____

Book mark : _____

[Signature]

(339)

Copyist.

24 | **1 Cav. | U.S.C.T.**

Edward Perry
_____, Co. E, 1 Reg't U. S. Col'd Cavalry.

Appears on

Company Muster Roll

for *Nov & Dec*, 186*4*.

Joined for duty and enrolled :

When *Dec 3*, 186*4*.*

Where *Newport News, Va.* *

Period *3* years.*

Present or absent *Present*

Stoppage, \$ *100* for _____

Due Gov't, \$ *100* for _____

Valuation of horse, \$ *100*

Valuation of horse equipments, \$ *100*

Remarks: *See list from*
muster-in roll.

* ~~See~~ See enrollment on card from muster-in roll.

Book mark : _____

(358c)

W. J. ...

Copyist.

Y. | **1 Cav.** | **U.S.C.T.**

Edward Young
Priv., Co. E, 1 Reg't U. S. Cav'd Cavalry.

Appears on

Company Muster Roll

for *Jan 7 Feb.*, 1865.

Joined for duty and enrolled :

When *Dec., 3*, 1864.*

Where *New York News Co.* *

Period *3* years.*

Present or absent *Present.*

Stoppage, \$ *100* for

Due Gov't, \$ *100* for

Valuation of horse, \$ *100*

Valuation of horse equipments, \$ *100*

Remarks: *Pay due from*
Gov't's serv. Rec'd
\$100.00 N.Y. County.

* See enrollment on card from muster-in roll.

Book mark :

Wagner
 (358c) Copyist.

W. J. ... | **1 Cav. | U.S.C.T.**
Almond Young
Chf., Co. E, 1 Reg't U. S. Cold Cavalry.

Appears on

Company Muster Roll

for *Mar + Apl.*, 1865.

Joined for duty and enrolled :

When *Dec. 3*, 1864.*

Where *Newport News* *

Period *3* years.*

Present or absent *Present.*

Stoppage, \$ *100* for

Due Gov't, \$ *100* for

Valuation of horse, \$ *100*

Valuation of horse equipments, \$ *100*

Remarks: ** Pay due from*
indistinct
due U.S. per one period
\$20.
Supplies on roll.

* See enrollment on card from muster-in roll.

Book mark :

(358c)

Magnum

Copyist.

Y.

1 Cav.

U.S.C.T.

Edward Young

Priv., Co. E, 1 Reg't U. S. Col'd Cavalry.

Appears on

Company Muster Roll

for *May & June*, 1865.

Joined for duty and enrolled:

When *Dec 3*, 1864.*

Where *Newport News.* *

Period *3* years.*

Present or absent *Present.*

Stoppage, \$ *100* for

Due Gov't, \$ *100* for

Valuation of horse, \$ *100*

Valuation of horse equipments, \$ *100*

Remarks: *Due the U.S. for 1
Colt's Pistol lost \$20.*

* ~~See~~ See enrollment on card from muster-in roll.

Book mark:

(358c)

W. H. ...
Copyist.

14 | 1 Cav. | U.S.C.T.

x Edward Young
 Pvt., Co. E, 1 Reg't U. S. Col'd Cavalry.

Appears on

Company Muster Roll

for July & Aug., 1865.

Joined for duty and enrolled:

When Dec 3, 1864.*

Where Newport News *

Period 3 years.*

Present or absent Present.

Stoppage, \$ 100 for

Due Gov't, \$ 100 for

Valuation of horse, \$ 100

Valuation of horse equipments, \$ 100

Remarks:

x Borne under "Present" as
 "Cyrus Young."

* See enrollment on card from muster-in roll.

Book mark:

A. W. L.

4 | **1 Cav. | U.S.C.T.**

Edward Young
Priv., Co. E, 1 Reg't U. S. Col'd Cavalry.

Appears on

Company Muster Roll

for *Sept + Oct*, 186*5*.

Joined for duty and enrolled:

When *Dec 1*, 186*4*.*

Where *Ft. Monroe* *

Period *3* years.*

Present or absent *Present*

Stoppage, \$ *100* for

Due Gov't, \$ *100* for

Valuation of horse, \$ *100*

Valuation of horse equipments, \$ *100*

Remarks: _____

* ~~See~~ See enrollment on card from muster-in roll.

Book mark: _____

W. Allen

(358c)

Copyist.

7 | **1 Cav. | U.S.C.T.**

Edward Young

Priv., Co. E, 1 Reg't U. S. Col'd Cavalry.

Appears on

Company Muster Roll

for *Nov & Dec*, 186*5*.

Joined for duty and enrolled :

When *Dec 3*, 186*4*.*

Where *N. Port News* *

Period *3* years.*

Present or absent *Present*

Stoppage, \$ *100* for

Due Gov't, \$ *100* for

Valuation of horse, \$ *100*

Valuation of horse equipments, \$ *100*

Remarks: _____

* ~~See~~ See enrollment on card from muster-in roll.

Book mark: _____

A. W. Allen

W | 1 Cav. | U.S.C.T.

Edward Young

He, Co. *E*, 1 Reg't U. S. Colored Cav.

Appears on Returns as follows:

Dec 18 64 *Dec 3 64*
Grain Co from Reg't
Depot

Book mark:

Chas. J. Satter

(546)

Copyist.

Y | *1 Cav* | U.S.C.T.

Edward Young

Piv, Co. *C*, *1* Reg't U. S. Col'd *Cav*

Appears on **Co. Muster-out Roll**, dated

Brazos Santiago Texas, Feb 4, 1866 .

Muster-out to date *Feb 4*, 1866 .

Last paid to *Aug 31*, 1865 .

Clothing account:

Last settled....., 186 ; drawn since \$.....¹⁰⁰

Due soldier \$.....¹⁰⁰; due U. S. \$ *6* ^{*20*}/_{*100*}

Am't for cloth'g in kind or money adv'd \$.....¹⁰⁰

Due U. S. for arms, equipments, &c., \$.....¹⁰⁰

Bounty paid \$ *100* ^{*100*}/_{*100*}; due \$ *none* ^{*100*}/_{*100*}

Remarks: *Joined as a recruit.*

Book mark :

Aw Allen

(361)

Copyist.

Young Edward
1st, Co. _____, _____ Reg't *156600*

Enclosures.

Bed Cards	Final Statements
Burial Records	Furloughs or L. of A.
Certs. of Dis. for Discharge	Med. Certificates
C. M. Charges	Med. Des. Lists
Descriptive Lists	Orders
Discharge Certificates	Pris. of War Record
Enlistment Papers	Resignations

Other papers relating to—

Admission to Hosp'l	Furlough or L. of A.
Casualty Sheet	Med. Examination
Confinement	Misc. Information
Contracts	Pay or Clothing
Death or Effects	Personal Reports
Desertion	Rank
Discharge from Hosp'l	Transfer to Hosp'l
Discharge from Service	Transfer to V. R. C.
Duty	Transportation

NOTE 1.—This blank will be used for both enlistments and re-enlistments—enlistment of veterans, &c., &c., in the volunteer service. They will be made out in duplicate in all cases—one to accompany the recruiting return of the superintendent (not the recruiting officer) to the Adjutant-General, and one to accompany the accounts of the officer who pays bounty, &c. The Regiment and Company in which the soldier last served should be given on the back.

NOTE 2.—An enlistment holds to service. A muster-in must, in all cases, precede payment of pay, bounty, pension, &c. A muster-in roll must, in all cases, be filed in the Adjutant-General's Office as evidence of muster-in. The mustering officer, commissary, or assistant-commissary of musters, as the case may be, will countersign both enlistments as having mustered the soldier into the service of the United States before either of them is given to the disbursing officer.

DECLARATION OF RECRUIT.

I, Eduard Young desiring to VOLUNTEER as a Soldier in the Army of the United States, for the term of THREE YEARS, Do Declare, That I am twenty three years and _____ months of age; that I have never been discharged from the United States service on account of disability or by sentence of a court-martial, or by order before the expiration of a term of enlistment; and I know of no impediment to my serving honestly and faithfully as a soldier for three years.

GIVEN at Norfolk Va the 10 day of December 1864

Witness: H. K. Sturtevant Eduard Young
Master

No. 19

Eduard Young
Volunteered at Norfolk Va

By St M
3^d Regiment of Mass

Discharged _____ 18____
enlistment; last served in Company ()
1st Regt of Mass Cavalry

CONSENT IN CASE OF MINOR.

I, _____ Do CERTIFY, That I am _____ the _____ of _____; that the said _____ is _____ years of age; and I do hereby freely give my CONSENT to his volunteering as a SOLDIER in the ARMY OF THE UNITED STATES, for the period of THREE YEARS.

GIVEN at _____ the _____ day of _____

Witness: _____

VOLUNTEER ENLISTMENT.

STATE OF



TOWN OF

Mass

1st Dist

I, *Edward Young* born in *Sussex Co*
 in the State of *Virginia* aged *twenty three* years,
 and by occupation a *Sabon* DO HEREBY ACKNOWLEDGE to have
 volunteered this *first* day of *December* 1864,
 to serve as a **Soldier** in the Army of the United States of America, for the
 period of **THREE YEARS**, unless sooner discharged by proper authority: Do also
 agree to accept such bounty, pay, rations, and clothing, as are, or may be, estab-
 lished by law for volunteers. And I, *Edward Young* do
 solemnly swear that I will bear true faith and allegiance to the **United States**
of America, and that I will serve them honestly and faithfully against all their
 enemies or opposers whomsoever; and that I will observe and obey the orders of
 the President of the United States, and the orders of the officers appointed over
 me, according to the Rules and Articles of War.

Sworn and subscribed to, at *Newport News*
 on this *3* day of *Dec* 1864
 BEFORE *M. Monroe*
1st Lt 37th U.S.C.T.
Edward Young
mark

I CERTIFY, ON HONOR, That I have carefully examined the above-named Volunteer, agreeably
 to the General Regulations of the Army, and that, in my opinion, he is free from all bodily defects and
 mental infirmity, which would in any way disqualify him from performing the duties of a soldier.

W. H. Gray
Ass't. Surg. 1st Lt. U.S.C.
 EXAMINING SURGEON.

I CERTIFY, ON HONOR, That I have minutely inspected the Volunteer, *Edward Young*
 previously to his enlistment, and that he was entirely sober when enlisted; that, to the best of my
 judgment and belief, he is of lawful age; and that, in accepting him as duly qualified to perform the duties
 of an able-bodied soldier, I have strictly observed the Regulations which govern the recruiting service.
 This soldier has *black* eyes, *black* hair, *black* complexion, is *five* feet
six inches high.

James M. Monroe
1st Lt 37th Regiment of *U.S.C.T.* Volunteers,
 RECRUITING OFFICER.

Mustered into the service of the United States, in Company *First*,
 the *3rd* day of *December*, 1864, at *Newport News, Va.*
Produced to 1st District - Massachusetts
 Regiment of *U.S.C. Cavalry*, Volunteers, on
Philip Morris
Adj. G. U.S. Cavalry
Chief Muster Officer

1538

Young Felix E
 Co L, 1 U. S. Col'd Cav.

Private | Private

CARD NUMBERS.

1	5299899	26
2	5299900	27
3	5314824	28
4	5314886	29
5	5314960	30
6	5315020	31
7	5315081	32
8	5315137	33
9	9087024	34
10	40725556	35
11		36
12		37
13		38
14		39
15		40
16		41
17		42
18		43
19		44
20		45
21		46
22		47
23		48
24		49
25		50

Book Mark

See also

J. | 1 Cav. | U.S.C.T.

Felix Young
Pop. Co. *L.*, 1 Reg't U.S. Col'd Cav.

Appears on

Company Descriptive Book

of the organization named above.

DESCRIPTION.

Age *20* years; height *5* feet *4 1/2* inches.

Complexion *Blk*

Eyes; *Blk* hair *Blk*

Where born *Ohio*

Occupation *Shoemaker*

ENLISTMENT.

When *Jan. 21/65*

Where *N.Y. City*

By whom *L. Pyne*; term *3* y'rs.

Remarks:

Daygett

A. C. W. | **U.S.C.T.**

Felix E. Young

Appears with rank of *Private* on

Muster and Descriptive Roll of a Detachment of U. S. Vols. forwarded

for the *1st* Reg't U. S. Col'd *Carney* Roll dated *Carters Landing*, *Jan 21*, 1865.

Where born *Ohio*

Age *20* y'rs; occupation *Shoe Maker*

When enlisted *Jan 2*, 1865.

Where enlisted *New York*

For what period enlisted *3* years.

Eyes *Black*; hair *Black*

Complexion *Black*; height *5* ft. *7* in.

When mustered in *Jan 2*, 1865.

Where mustered in *New York*

Bounty paid \$ *100* ^{*00*} _{*100*}; due \$ *100*

Where credited *Young's*

Company to which assigned

Remarks:

Book mark:

[Signature]
Copyist.

4 | 1 Cav. | U.S.C.T.

Julius E Young

Appears with rank of *Private* on

Muster and Descriptive Roll of a Detachment of U. S. Vols. forwarded

for the 1 Reg't U. S. Col'd Cavalry. Roll dated

Fort Island NY 24, 1865.

Where born *Ohio*

Age *20* y'rs; occupation *Shoemaker*

When enlisted *Jan 21*, 1865.

Where enlisted *NY city*

For what period enlisted *3* years.

Eyes *BR*; hair *BR*

Complexion *BR*; height *5* ft. *4 1/3* in.

When mustered in *Jan 21*, 1865.

Where mustered in *NY city*

Bounty paid \$ *100*; due \$ *100*

Where credited *NY city - 9 Cong Dist Mass*

Company to which assigned

Remarks:

Book mark:

Atwood

Y | 1 Cav. | U.S.C.T.

Delix Young

Pr, Co. L, 1 Reg't U. S. Col'd Cavalry.

Age _____ years.

Appears on

Company Muster Roll*

for *from Julistmt, to apr, 30, 186 5.*

Joined for duty and enrolled:

When _____, 186 .

Where _____

Period *3* years.

Mustered in:

When *July, 21*, 186 *5.*

Where *W. G. City*

Present or absent *Present*

Stoppage, \$ *100* for _____

Due Gov't, \$ *100* for _____

Valuation of horse, \$ *100*

Valuation of horse equipments, \$ *100*

Remarks: *Substitute*

* First current roll. No muster-in roll of this company on file.

Book mark : _____

(3586)

Ref

Copyist.

Y | 1 Cav. | U.S.C.T.

Pelip Young

Pl, Co. L, 1 Reg't U. S. Col'd Cavalry.

Appears on

Company Muster Roll

for *May 1 June 5*, 186

Present or absent *Present*

Stoppage, \$ 100 for

Due Gov't, \$ 100 for

Valuation of horse, \$ 100

Valuation of horse equipments, \$ 100

Remarks:

Book mark: _____

Pl

(358) Copyist.

Y | **1 Cav.** | **U.S.C.T.**

Felix Young

Pl, Co. L, 1 Reg't U. S. Col'd Cavalry.

Appears on

Company Muster Roll

for *July & Aug., 1865*

Present or absent *Present*

Stoppage, \$ 100 for

Due Gov't, \$ 100 for

Valuation of horse, \$ 100

Valuation of horse equipments, \$ 100

Remarks:

Book mark:

(358)

Ref

Copyist.

G | 1 Cav. | U.S.C.T.

Delix Young

Pat, Co. L, 1 Reg't U. S. Col'd Cavalry.

Appears on

Company Muster Roll

for *Sept. & Oct., 1865*

Present or absent *Present*

Stoppage, \$ 100 for

Due Gov't, \$ 100 for

Valuation of horse, \$ 100

Valuation of horse equipments, \$ 100

Remarks:

Book mark:

(358)

Perf

Copyist.

Y | 1 Cav. | U.S.C.T.

Felix Young
Pvt, Co. L, 1 Reg't U. S. Col'd Cavalry.

Appears on

Company Muster Roll

for Nov. 1 Dec., 1865

Present or absent Present

Stoppage, \$ 100 for

Due Gov't, \$ 100 for

Valuation of horse, \$ 100

Valuation of horse equipments, \$ 100

Remarks:
.....
.....
.....
.....
.....
.....
.....
.....
.....
.....

Book mark:

(358) C. R. P. Copyist.

Cy | 1 Cav. | U.S.C.T.

Felix Brown

mus, Co. *L*, 1 Reg't U. S. Colored Cav.
mus

Appears on Returns as follows:

April 1863. on duty in Mass

May to Sept 1863. (Mus) on duty in Mass

*Oct Nov 1863. (Priv) on duty
Regt Mass J.C. Hayes, vice*

Book mark :

Chas. Brown

G | **1 Cav. | U.S.C.T.**

Delix Young
R, Co. *L*, 1 Reg't U. S. Col'd Cavalry.

Appears on **Co. Muster-out Roll**, dated
Brazos Santiago Tex. Dec. 4, 186*6*.
 Muster-out to date *Dec. 4*, 186*6*.
 Last paid to *Aug. 31*, 186*5*.

Clothing account:

Last settled....., 186 ; drawn since \$.....100
 Due soldier \$.....100; due U. S. \$ *59* 71/100
 Am't for cloth'g in kind or money adv'd \$.....100

Due U. S. for arms, equipments, &c., \$.....100

Bounty paid \$ *100* 100; due \$ *none* 100

Remarks: *Joined as Rec't.*

Book mark :

(361)

Rif

Copyist.

Young Felix E.
Co., *1st* Reg't *156th*

4 Enclosures.

Bed Cards	Final Statements
Burial Records	Furloughs or L. of A.
Certs. of Dis. for Discharge	Med. Certificates
C. M. Charges	Med. Des. Lists
Descriptive Lists	Orders
Discharge Certificates	Pris. of War Record
Enlistment Papers	Resignations

Other papers relating to—

Admission to Hosp'l	Furlough or L. of A.
Casualty Sheet	Med. Examination
Confinement	Misc. Information <i>✓</i>
Contracts	Pay or Clothing
Death or Effects	Personal Reports
Desertion	Rank
Discharge from Hosp'l	Transfer to Hosp'l
Discharge from Service	Transfer to V. R. C.
Duty	Transportation

Record and Pension Office,

WAR DEPARTMENT.

The slip hereto attached is a stub from a "Pass Book", Headquarters Department of Washington.

No. *14* *9* *15*

Name *H. E. Gentry*

Reg't *U. S. S. C.*

Reason *Pass on the*

Recommended by *Paulough*

Date *June 6*

Expires *" 7 63*

AFFIDAVIT OF

Pelley E Young

Dated *January 21st* 186*5*.

STATE OF NEW YORK,

County of *New York*

} SS :

I, *Felix E Young*, do solemnly swear that I am between the age of eighteen and forty-five years, and ~~not subject to draft, by reason of~~

SWORN TO BEFORE ME,

This *27th* day of *January*, 186*4* D.S.

Felix E Young
Charles H. Ryan
1st Lieut 6th Regt
Mustering Officer.

DECLARATION OF RECRUIT.

I *Philip B. Young* desiring to VOLUNTEER as a Soldier in the Army of the United States, for the term of THREE YEARS, Do Declare, That I am *Twenty* years and _____ months of age; that I have never been discharged from the United States service on account of disability or by sentence of a court-martial, or by order before the expiration of a term of enlistment; and I know of no impediment to my serving honestly and faithfully as a soldier for three years.

GIVEN at NEW YORK,

the *24th* day of *January*, 186*5*

Witness:

Wm. H. B. Endo *Philip B. Young*

No. 5516

X/

Philip B. Young
Volunteered at New York, *24th* 186*5*

By *Dr. John M. Brown*
Co. Regiment of *W. I. Jones*

enlistment; last served in Company ()

Reg't of _____

Discharged _____ 18 _____

Wm. S. Baldi

This is a copy of the original document filed in the National Archives and Records Administration.

CONSENT IN CASE OF MINOR.

I, _____ Do CERTIFY, That I am the _____ of _____, that the said _____ is _____ years of age; and I do hereby freely give my CONSENT to his volunteering as a SOLDIER in the ARMY OF THE UNITED STATES for the period of THREE YEARS.

GIVEN at _____ the _____ day of _____

Witness: _____

(A. G. O. No. 74 & 76.)

VOLUNTEER ENLISTMENT.

STATE OF NEW YORK.



CITY OF NEW YORK.

the day of 1864, at NEW YORK.

Mustered into the service of the United States, in Company /

1st New York Regiment of

James M. ... Volunteers, on

I, Felix E. Young born in Ohio in the State of aged Twenty years, and by occupation a Shoemaker Do HEREBY ACKNOWLEDGE to have volunteered this Twenty first day of January 1864, to serve as a Soldier in the Army of the United States of America, for the period of THREE YEARS unless sooner discharged by proper authority: Do also agree to accept such bounty, pay, rations, and clothing, as are, or may be, established by law for volunteers. And I, Felix E. Young do solemnly swear, that I will bear true faith and allegiance to the United States of America, and that I will serve them honestly and faithfully against all their enemies or opposers whomsoever; and that I will observe and obey the orders of the President of the United States, and the orders of the officers appointed over me, according to the Rules and Articles of War.

Sworn and subscribed to, at NEW YORK,

this 21 day of January 1864

BEFORE

Charles DeBryne } Felix E. Young
1st Lt. Co. 1st N.Y. Inf. } (mark)

I CERTIFY, ON HONOR, That I have carefully examined the above-named Volunteer, agreeably to the General Regulations of the Army, and that, in my opinion, he is free from all bodily defects and mental infirmity, which would in any way disqualify him from performing the duties of a soldier.

EXAMINING SURGEON.

I CERTIFY, ON HONOR, That I have minutely inspected the Volunteer Felix E. Young previously to his enlistment, and that he was entirely sober when enlisted; that, to the best of my judgment and belief, he is of lawful age; and that, in accepting him as duly qualified to perform the duties of an able-bodied soldier, I have strictly observed the Regulations which govern the recruiting service.

This soldier has Black eyes, Black hair, Black complexion, is 5 feet

4 1/4 inches high,

Charles DeBryne
1st Lt. Co. 1st N.Y. Inf. Regiment of W.S. Inf. N.Y. Volunteers

RECRUITING OFFICER.

DECLARATION OF RECRUIT.

I *Felix E. Young* desiring to VOLUNTEER as a Soldier in the Army of the United States, for the term of THREE YEARS, Do Declare, That I am *Twenty* years and _____ months of age; that I have never been discharged from the United States service on account of disability or by sentence of a court-martial, or by order before the expiration of a term of enlistment; and I know of no impediment to my serving honestly and faithfully as a soldier for three years.

GIVEN at NEW YORK,

the *24th* day of *January* 186*5*

Witness:

J. Co. No. 1. R. Eachs

Felix E. Young

Discharged

18

Reg't of

enlistment; last served in Company ()

By *Dr. James H. Jones*
Co. Regiment of N. S. Inftry

Volunteered at New York,

Felix E. Young

W. M. G. L. Parvley
No. *500*

CONSENT IN CASE OF MINOR.

I, _____ Do CERTIFY, That I am the _____ of _____, that the said _____ is _____ years of age; and I do hereby freely give my CONSENT to his volunteering as a SOLDIER in the ARMY OF THE UNITED STATES for the period of THREE YEARS.

GIVEN at _____

the _____ day of _____

Witness:

VOLUNTEER ENLISTMENT.

STATE OF NEW YORK.



CITY OF NEW YORK.

the day of, 1864, at NEW YORK.

Mustered into the service of the United States, in Company

1st Co. 68th Regt. of

1st Div. 3rd Corps, U.S. Army
Volunteers, on

I, Pelix E. Young born in Ohio
in the State of aged Twenty years,
and by occupation Shoemaker DO HEREBY ACKNOWLEDGE to have
volunteered this Twenty first day of January 1864,
to serve as a **Soldier** in the **Army of the United States of America**, for the
period of **THREE YEARS** unless sooner discharged by proper authority: Do also
agree to accept such bounty, pay, rations, and clothing, as are, or may be, estab-
lished by law for volunteers. And I, Pelix E. Young do
solemnly swear, that I will bear true faith and allegiance to the **United States
of America**, and that I will serve them honestly and faithfully against all their
enemies or opposers whomsoever; and that I will observe and obey the orders of
the President of the United States, and the orders of the officers appointed over
me, according to the Rules and Articles of War.

Sworn and subscribed to, at NEW YORK,
this 24th day of January 1864
BEFORE Charles DePue
1st Lt. Co. W.S. Infy

Pelix E. Young
M.C.

I CERTIFY, ON HONOR, That I have carefully examined the above-named Volunteer, agreeably
to the General Regulations of the Army, and that, in my opinion, he is free from all bodily defects and
mental infirmity, which would in any way disqualify him from performing the duties of a soldier.

Charles DePue
M.C.

EXAMINING SURGEON.

I CERTIFY, ON HONOR, That I have minutely inspected the Volunteer Pelix E. Young
previously to his enlistment, and that he was entirely sober when enlisted; that, to the best of my
judgment and belief, he is of lawful age; and that, in accepting him as duly qualified to perform the duties
of an able-bodied soldier, I have strictly observed the Regulations which govern the recruiting service.

This soldier has Blue eyes, Black hair, Black complexion, is 5 feet
4 1/4 inches high,
Charles DePue
1st Lt. Co. W.S. Infy Regiment of W.S. Infy Volunteers.

M.C. RECRUITING OFFICER.

(A. G. O. No 74 & 78.)

1907

Young George
Co D, 1 U. S. Col'd Cav.

Private Private

CARD NUMBERS.

1	5305253	26
2	5305322	27
3	5305395	28
4	5305474	29
5	5305550	30
6	53050279	31
7	5305626	32
8	5305730	33
9	5305820	34
10	5305941	35
11	5306057	36
12	5306160	37
13	5306257	38
14	5306355	39
15	5306458	40
16	5306541	41
17	9086105	42
18		43
19		44
20		45
21		46
22		47
23		48
24		49
25		50

Book Mark:

See also

REF 361955.
S 1348640 - P.O. MEM
S. 1404391 P.O. aff.

Thos. C. Hatch
Esq.

G. | 1 Cav. | U.S.C.T.

George Young,

Co. *D*; 1 Reg't U.S. Col'd Cav.

Appears on

Company Descriptive Book

of the organization named above.

DESCRIPTION.

Age *36* years; height *5* feet *7* inches.

Complexion *Dark.*

Eyes; *Dark.* hair *Dark.*

Where born *Gloucester Co. Va.*

Occupation *Labourer.*

ENLISTMENT.

When *Dec 10/63.*

Where *Norfolk Va.*

By whom *Capt Brown*; term *3* y'rs.

Remarks: *Corporal.*

Dickerson,

4 | **1 Cav.** | **U.S.C.T.**

George Young

Plt., Co. *R*, 1 Reg't U. S. Col'd Cavalry.

Age *20* years.

Appears on

Company Muster-in Roll

of the organization named above. Roll dated

Camp Hamilton Va Dec 22, 1863.

Muster-in to date *Dec 22*, 1863.

Joined for duty and enrolled:

When *Dec 10*, 1863.

Where *Norfolk Va*

Period *3* years.

Valuation of horse, \$.....100

Valuation of horse equipments, \$.....100

Remarks:

Book mark:

E. B. Thompson

(356)

Copyist.

4 | 1 Cav. | U.S.C.T.

George Yerring

Plt, Co. D, 1 Reg't U. S. Col'd Cavalry.

Appears on

Company Muster Roll

for *from Dec 27 to Dec 31*, 1863.

Present or absent *Present*

Stoppage, \$ 100 for

Due Gov't, \$ 100 for

Valuation of horse, \$ 100

Valuation of horse equipments, \$ 100

Remarks:

Book mark:

E. B. Monahan

(358)

Copyist.

Y | 1 Cav. | U.S.C.T.

George Young

Pvt, Co. D, 1 Reg't U. S. Col'd Cavalry.

Appears on

Company Muster Roll

for *Jan + Feb*, 1864.

Present or absent *Present*

Stoppage, \$ *100* for

Due Gov't, \$ *100* for

Valuation of horse, \$ *100*

Valuation of horse equipments, \$ *100*

Remarks:

Book mark:

E. B. Thompson

(358)

Copyist.

Y | **1 Cav.** | **U.S.C.T.**

George Young
Priv, Co. D, 1 Reg't U. S. Col'd Cavalry.

Appears on

Company Muster Roll

for *Mich & Apr*, 1864.

Present or absent *Present*

Stoppage, \$ 100 for

Due Gov't, \$ 100 for

Valuation of horse, \$ 100

Valuation of horse equipments, \$ 100

Remarks:
.....
.....
.....
.....
.....
.....
.....
.....
.....
.....

Book mark:

(358)

E. B. Thompson
Copyist.

G | 1 Cav. | U.S.C.T.

George Young
Ret, Co. D, 1 Reg't U.S. Col'd Cavalry.

Appears on

Company Muster Roll

for *May & June*, 1864.

Present or absent *Absent*

Stoppage, \$ *100* for

Due Gov't, \$ *100* for

Valuation of horse, \$ *100*

Valuation of horse equipments, \$ *100*

Remarks *Abs on det ch duty since June 26. In Sp. orders dated Oct 2nd 1864. A.C. June 26. 1864*

Book mark:

E. B. Thompson

(358)

Copyist.

27 | 1 Cav. | U.S.C.T.

George Young

, Co., | Reg't U. S. Col'd Cavalry

Appears on a

Detachment Muster Roll

of the organization named above

for May & June, 1864.

Station On the field Va^{near} Petersburg

Present or absent Present

Stoppage, \$ 100 for

Due Gov't, \$ 100 for

Valuation of horse, \$ 100

Valuation of horse equipments, \$ 100

Remarks :

Book mark :

Hammer

(344)

Copyist.

1 Cav. U.S.C.T.

G
George Young
Rt, Co. D, 1 Reg't U. S. Col'd Cavalry.

Appears on

Company Muster Roll

for *July & Aug.*, 186*1* /.

Present or absent *Present*

Stoppage, \$ *100* for

Due Gov't, \$ *100* for

Valuation of horse, \$ *100*

Valuation of horse equipments, \$ *100*

Remarks:

Book mark:

E. B. Thompson

(358)

Copyist.

M

1 Cav. | U.S.C.T.

George Young

Pvt

, Co. D, 1 Reg't U. S. Col'd Cavalry.

Appears on

Company Muster Roll

for *March 1861*, 186*1*.

Present or absent *Present*

Stoppage, \$ *100* for

Due Gov't, \$ *100* for

Valuation of horse, \$ *100*

Valuation of horse equipments, \$ *100*

Remarks:

Book mark:

Asm

(358)

Copyist.

1 Cav. U.S.C.T.

George Young
Pat, Co. D, 1 Reg't U.S. Col'd Cavalry.

Appears on

Company Muster Roll

for *Nov 1864*, 1864.

Present or absent *Present*

Stoppage, \$ *100* for

Due Gov't, \$ *100* for

Valuation of horse, \$ *100*

Valuation of horse equipments, \$ *100*

Remarks:

Book mark:

(358)

W. Brown

Copyist.

4 | 1 Cav. | U.S.C.T.

George Young

Pr, Co. D, 4 Reg't U. S. Col'd Cavalry.

Appears on

Company Muster Roll

for *June 27th*, 186*9*:

Present or absent *Present*

Stoppage, \$ *100* for

Due Gov't, \$ *100* for

Valuation of horse, \$ *100*

Valuation of horse equipments, \$ *100*

Remarks:

Book mark: -----

Abner

(358) Copyist.

11 | **1 Cav. | U.S.C.T.**

James Henry

11, Co. D, 1 Reg't U. S. Col'd Cavalry.

Appears on

Company Muster Roll

for *Mar 7 April*, 186*5*.

Present or absent *Present*

Stoppage, \$ *100* for

Due Gov't, \$ *100* for

Valuation of horse, \$ *100*

Valuation of horse equipments, \$ *100*

Remarks:

Book mark: -----

James

(358) Copyist.

4 | **1 Cav. | U.S.C.T.**

George Spring
Pvt, Co. D, 1 Reg't U. S. Col'd Cavalry.

Appears on

Company Muster Roll

for May & June, 1865.

Present or absent Present

Stoppage, \$ 100 for

Due Gov't, \$ 100 for

Valuation of horse, \$ 100

Valuation of horse equipments, \$ 100

Remarks:

Book mark : -----

(358)

W. H. ...

Copyist.

1 Cav. U.S.C.T.

James Spring
No 2, Co. D, 1 Reg't U. S. Col'd Cavalry.

Appears on

Company Muster Roll

for *May 21st*, 186*7*.

Present or absent *Present*

Stoppage, \$ *100* for

Due Gov't, \$ *100* for

Valuation of horse, \$ *100*

Valuation of horse equipments, \$ *100*

Remarks:

Book mark:

James Spring
(358) Copyist.

Y. | **1 Cav.** | **U.S.C.T.**

George Young

Priv., Co. D, 1 Reg't U. S. Col'd Cavalry.

Appears on

Company Muster Roll

for *Sept. & Octo.*, 186*5*.

Present or absent *present*

Stoppage, \$ *100* for

Due Gov't, \$ *100* for

Valuation of horse, \$ *100*

Valuation of horse equipments, \$ *100*

Remarks:

Book mark:

R. E. Wilson

(358)

Copyist.

7 | 1 Cav. | U.S.C.T.

George Young

Priv., Co. D, 1 Reg't U. S. Col'd Cavalry.

Appears on

Company Muster Roll

for *Nov. & Dec*, 186*5*.

Present or absent *present*

Stoppage, \$ *100* for

Due Gov't, \$ *100* for

Valuation of horse, \$ *100*

Valuation of horse equipments, \$ *100*

Remarks:

Book mark:

R. E. Wilson

(358)

Copyist.

Y | **1 Cav.** | **U.S.C.T.**

George Young
Priv., Co. D, 1 Reg't U. S. Col'd Cavalry.

Appears on **Co. Muster-out Roll**, dated
Brazos Santiago, Tex., Feb. 4, 1866.
Muster-out to date Feb. 4, 1866.
Last paid to Aug. 31, 1866.

Clothing account:

Last settled _____, 186 ; drawn since \$ 100
Due soldier \$ 12 ⁷² / 100; due U. S. \$ 100
Am't for cloth'g in kind or money adv'd \$ 100

Due U. S. for arms, equipments, &c., \$ 100

Bounty paid \$ 100; due \$ 100

Remarks: Joined at orig. reg.

Book mark : _____

R. E. Wilson

(361)

Copyist.

1540

Young, James

Co I, 1 U. S. Col'd Cav.

Personal papers herein.

Private

Private

CARD NUMBERS.

1	5299325	26
2	5312248	27
3	5312325	28
4	5312405	29
5	5313390	30
6	7086830	31
7	9086696	32
8	40725557	33
9		34
10		35
11		36
12		37
13		38
14		39
15		40
16		41
17		42
18		43
19		44
20		45
21		46
22		47
23		48
24		49
25		50

Book Mark: E.B. V. 10 P. 13.

See also

Y | **1 Cav. | U.S.C.T.**
James Young
 _____, Co. _____, 1 Reg't U.S. Col'd Cav.

Appears on

Company Descriptive Book

of the organization named above.

DESCRIPTION.

Age *24* years ; height *5* feet *5* inches.

Complexion *light*

Eyes; *brown* hair *dark*

Where born *Norfolk Co. Va.*

Occupation *Boatman*

ENLISTMENT.

When *Jan. 13th 64*

Where *Norfolk*

By whom *H. Hudson* ; term *3* y'rs.

Remarks: *Died at Bermuda*
100 When not known

W. C. G. H.

J. | 1 Cav. | U.S.C.T.

James Young

....., Co. *D.*, 1 Reg't U.S. Col'd Cav.

Appears on

Company Descriptive Book

of the organization named above.

DESCRIPTION.

Age *27* years ; height *5* feet *3* inches.

Complexion *light*

Eyes; *brown* hair *dark*

Where born *Norfolk Co Virginia*

Occupation *Boatman*

ENLISTMENT.

When *Jan. 17th 1864*

Where *Norfolk Va.*

By whom *L. H. Hudson* ; term *3* y'rs.

Remarks: *Dead.*

.....
.....
.....
.....
.....
.....
.....
.....
.....
.....

Gaggett

Y | 1 Cav. | U.S.C.T.

James Young
Private, Co. I, 1 Reg't U. S. Col'd Cavalry.

Appears on

Company Muster Roll

for *Jan'y & Febr*, 1864.

Present or absent *present*

Stoppage, \$ *100* for

Due Gov't, \$ *100* for

Valuation of horse, \$ *100*

Valuation of horse equipments, \$ *100*

Remarks:

Book mark: -----

M. A. Michael
(358) Copyist.

G | 1 Cav. | U.S.C.T.

James Young
Prk

Appears with rank of _____ on

Muster and Descriptive Roll of a Detachment of U. S. Vols. forwarded

for the 1 Reg't U. S. Col'd Cavalry. Roll dated

Camp Mine Va. Feby 22, 1864

Where born Norfolk Co. Va.

Age 29 y'rs; occupation Boatman

When enlisted Jan 19, 1864

Where enlisted Norfolk Va.

For what period enlisted 3 years.

Eyes Bro; hair Brk

Complexion Lh; height 5 ft. 5 in.

When mustered in _____, 186 .

Where mustered in _____

Bounty paid \$ 100; due \$ 100

Where credited _____

Company to which assigned _____

Remarks: _____

Book mark: _____

J. H. Harris

Y | 1 Cav. | U.S.C.T.

James Young
Private, Co. I, 1 Reg't U. S. Col'd Cavalry.

Appears on

Company Muster Roll
for *March & Apr*, 1864.

Present or absent *present*

Stoppage, \$ *100* for

Due Gov't, \$ *100* for

Valuation of horse, \$ *100*

Valuation of horse equipments, \$ *100*

Remarks:

Book mark:

M. A. Michaels

(358)

Copyist.

Y | 1 Cav. | U.S.C.T.

James Young
Private, Co. I, 1 Reg't U. S. Col'd Cavalry.

Appears on

Company Muster Roll

for *May & June*, 1864.

Present or absent

Stoppage, \$ 100 for

Due Gov't, \$ 100 for

Valuation of horse, \$ 100

Valuation of horse equipments, \$ 100

Remarks:

Book mark: *Died May 15/64*
E. B. V. - 11 P. 13

(358)

M. A. Michaels

Copyist.

4 | 1 Cav. | U.S.C.T.

James Young

Priv, Co. I, 1 Reg't U. S. Colored Cav.

Appears on Returns as follows:

May 18 64 absent. Orderly
for Gul Hink. since
Apr 29/64 at Camp Point

Book mark:

Chas. Dutton

(546)

Copyist.

Y. | *1 Cav.* | U. S. C. T.

James Young.
R., *Co.*, | *1* Reg't U. S. Col'd *Cav.*

Appears on **Co. Muster-out Roll**, dated

Cruzos Santiago Tex, Feb. 4, 1864.

Muster-out to date _____, 186 .

Last paid to _____, 186 .

Clothing account:

Last settled _____, 186 ; drawn since \$ _____ 100

Due soldier \$ _____ 100; due U. S. \$ _____ 100

Am't for cloth'g in kind or money adv'd \$ _____ 100

Due U. S. for arms, equipments, &c., \$ _____ 100

Bounty paid \$ _____ 100 due \$ _____ 100

Remarks: *Joined as recruit.*
Died at Bermuda 100
when - not known.

Book mark: *Died May 15/64,*
E. B. V 10 - P. 13.

(361)

Kelly,

Copyist.

Young, James
Pt, Co. I, 1 Reg't U.S.C. Cav.

3 Enclosures.

Bed Cards	Descriptive Lists
Burial Records	Final Statements
Certs. of Dis. for Discharge	Furloughs
C. M. Charges	Med. Des. Lists
Med. Certificates	Orders

Encl. pps - 2

Other papers relating to—

Admission to Hosp'l	Furlough
Casualty Sheet (Officer's)	Med. Examination
Confinement	Misc. Information
Contracts	Pay or Clothing
Death or Effects	Personal Reports
Desertions	Rank
Discharge from Hosp'l	Transfer to Hosp'l
Discharge from Service	Transfer to V. R. C.
Duty	Transportation

MICROFILM PUBLICATION M 1817

COMPILED MILITARY SERVICE RECORDS
OF VOLUNTEER UNION SOLDIERS WHO
SERVED WITH THE USCT (US COLORED TROOPS)
1ST REGIMENT OF CAVALRY

PERSONAL PAPERS' TARGET SHEET

PLEASE NOTE THE CHECKED INFORMATION ABOUT THE PERSONAL PAPERS IN
THIS FILE:

- NO PERSONAL PAPERS WERE FOUND IN THIS FILE WHEN THE
RECORDS WERE ARRANGED FOR MICROFILMING.
- 4 PERSONAL PAPER(S) FOUND IN THIS FILE WHEN THE RECORDS
WERE ARRANGED FOR MICROFILMING.

VOLUNTEER ENLISTMENT.

STATE OF

TOWN OF

Virginia



I, James Young born in Norfolk Co
 in the State of va aged 29 years,
 and by occupation a Boatsman Do HEREBY ACKNOWLEDGE to have
 volunteered this 19th day of January 1864,
 to serve as a **Soldier** in the **Army of the United States of America**, for the
 period of **THREE YEARS**, unless sooner discharged by proper authority: Do also
 agree to accept such bounty, pay, rations, and clothing, as are, or may be, estab-
 lished by law for volunteers. And I, James Young do
 solemnly swear, that I will bear true faith and allegiance to the **United States**
of America, and that I will serve them honestly and faithfully against all their
 enemies or opposers whomsoever; and that I will observe and obey the orders of
 the President of the United States, and the orders of the officers appointed over
 me, according to the Rules and Articles of War.

Sworn and subscribed to, at Norfolk
 this 19th day of January 1864,
 BEFORE Horace Hewlson
Lieut 1st U S Cavalry

James Young
 mark

I CERTIFY, ON HONOR, That I have carefully examined the above-named Volunteer, agreeably
 to the General Regulations of the Army, and that, in my opinion, he is free from all bodily defects and
 mental infirmity, which would in any way disqualify him from performing the duties of a soldier.

 EXAMINING SURGEON.

I CERTIFY, ON HONOR, That I have minutely inspected the Volunteer, _____
 previously to his enlistment, and that he was entirely sober when enlisted; that, to the best of my
 judgment and belief, he is of lawful age; and that, in accepting him as duly qualified to perform the duties
 of an able-bodied soldier, I have strictly observed the Regulations which govern the recruiting service.
 This soldier has brown eyes, dark hair, light complexion, is five feet
seven inches high.

Horace Hewlson
Lieut 1st Regiment of U S C Volunteers,
 RECRUITING OFFICER.

(A. G. O. No. 74 & 76.)

the _____ day of _____, 186 , at _____
 Mustered into the service of the United States, in Company _____ Regiment of _____ Volunteers, on

DECLARATION OF RECRUIT.

I, _____ desiring to VOLUNTEER as a Soldier in the Army of the United States, for the term of THREE YEARS, Do Declare, That I am _____ years and _____ months of age; that I have never been discharged from the United States service on account of disability or by sentence of a court-martial, or by order before the expiration of a term of enlistment; and I know of no impediment to my serving honestly and faithfully as a soldier for three years.

GIVEN at _____ the _____ day of _____

Witness: _____

No. _____

James Henry
Mustered at *Perforated* *Per*
19th *January* *1864,*
B. S. Deane
1st *Regiment of* *U.S.C.C.*

_____ enlistment; last served in Company ()

_____ Reg't of _____

Discharged _____ 18 _____

CONSENT IN CASE OF MINOR.

I, _____ Do CERTIFY, That I am _____ the _____ of _____; that the said _____ is _____ years of age; and I do hereby freely give my CONSENT to his volunteering as a SOLDIER in the ARMY OF THE UNITED STATES for the period of THREE YEARS.

GIVEN at _____ the _____ day of _____

Witness: _____

(A. G. O. No. 74 & 76.)

NOTE 1.—This blank will be used for both enlistments and re-enlistments—enlistment of veterans, &c., &c., in the volunteer service. They will be made out in duplicate in all cases—one to accompany the recruiting return of the superintendent (not the recruiting officer) to the Adjutant General, and one to accompany the accounts of the officer who pays bounty, &c. The Regiment and Company in which the soldier last served should be given on the back.
NOTE 2.—An enlistment holds to service. A muster-in must, in all cases, precede payment of pay, bounty, pension, &c. A muster-in roll must, in all cases, be filed in the Adjutant General's Office as evidence of muster-in. The mustering officer, commissary, or assistant commissary of musters, as the case may be, will countersign both enlistments as having mustered the soldier into the service of the United States before either of them is given to the disbursing officer.

NOV 2 1864

VOLUNTEER ENLISTMENT.

STATE OF

TOWN OF

Virginia



I, James Young born in Norfolk Co
 in the State of va aged _____ years,
 and by occupation a Boatman Do HEREBY ACKNOWLEDGE to have
 volunteered this 19th day of January 1864
 to serve as a **Soldier** in the **Army of the United States of America**, for the
 period of **THREE YEARS**, unless sooner discharged by proper authority: Do also
 agree to accept such bounty, pay, rations, and clothing, as are, or may be, estab-
 lished by law for volunteers. And I, James Young do
 solemnly swear, that I will bear true faith and allegiance to the **United States**
of America, and that I will serve them honestly and faithfully against all their
 enemies or opposers whomsoever; and that I will observe and obey the orders of
 the President of the United States, and the orders of the officers appointed over
 me, according to the Rules and Articles of War.

Sworn and subscribed to, at Norfolk
 this 19th day of January 1864,
 BEFORE George Hutton } James Young
Serjt - 1st U S Cavalry } merit

I CERTIFY, ON HONOR, That I have carefully examined the above-named Volunteer, agreeably to the General Regulations of the Army, and that, in my opinion, he is free from all bodily defects and mental infirmity, which would in any way disqualify him from performing the duties of a soldier.

EXAMINING SURGEON.

I CERTIFY, ON HONOR, That I have minutely inspected the Volunteer, _____ previously to his enlistment, and that he was entirely sober when enlisted; that, to the best of my judgment and belief, he is of lawful age; and that, in accepting him as duly qualified to perform the duties of an able-bodied soldier, I have strictly observed the Regulations which govern the recruiting service. This soldier has brown eyes, dark hair, light complexion, is five feet seven inches high.

George Hutton
 Serjt - 1st Regiment of U S C Volunteers,
 RECRUITING OFFICER.

(A. G. O. No. 74 & 76.)

Mustered into the service of the United States, in Company _____, Regiment of _____ Volunteers, on
 the _____ day of _____, 1864, at _____

WAR DEPARTMENT,

ADJUTANT GENERAL'S OFFICE,

WASHINGTON, *Aug 27th*, 1868.

SIR:

Final Statements in the cases of deceased soldiers are required to be sent to the Adjutant General's Office in duplicate, with one copy of the Inventory of Effects. The Descriptive List should also be sent to this Office in cases where the soldier was absent from his Company at the time of his death. Where there were no effects, it should be so stated on a blank Inventory, properly signed.

Certificates of Disability should be sent in duplicate. Special care should be taken that the date of discharge and signature of the discharging officer should be affixed.

No of the Final Statement *or* Inventory, has been received in the case of *Private James Young*, of Co. *"I"*, *1st* Regiment of *U.S. Cav.*, Volunteers, whose papers were forwarded to this Office. You will please forward the missing papers without delay.

I have the honor to be, sir,

He is reported as having Very respectfully,
died at Bermuda Hundred Your obedient servant,
Va. - date not known,

Samuel Grant

Assistant Adjutant General.
 (110)

~~Commanding Officer~~

Bot Lieut Colo.

J. J. Woodward

Asst. Surgeon, U.S. Army,

Surgeon General's Office

Washington, D.C.

H.P.

[OFFICE INDORSEMENT.]

War Department,

ADJUTANT GENERAL'S OFFICE,

March 7, 1874

The _____ of _____
 _____, _____, _____ Reg't U.S.
 Colored _____, is reported as follows:—

- On Company Muster Roll.
- For _____, 1864, _____, 1864
- Company Muster-out Roll.
- _____ 1864
- Company Descriptive Book.
- _____ 1864
- Company Morning Reports.
- _____ 1864
- Soldier's Final Statement.
- _____ 1864
- Soldier's Record of Death and Interment.
- _____ 1864
- Soldier's Inventory of Effects.
- _____ 1864
- Soldier's Certificate of Disability for Discharge.
- _____ 1864
- Soldier's Individual Muster-out Roll.
- _____ 1864
- Regimental Return.
- For _____, 1864, _____, 1864
- Regimental Quarterly Returns.
- _____ 1864
- Regimental Descriptive Book.
- _____ 1864
- By Surgeon General.
- _____ 1864

_____ May 15, 1864 is held to be
 the correct date, and the Company Muster
 Roll will be amended accordingly.

Thema D. Bennett
 E. B. 113 Dec letter to 2d. Adj. Genl.
 dated 16.11 April 2d 1874.
 Adjutant Reguter 311

CASUALTY SHEET

Complete,
 No. _____

James Young
 Private of Company _____
 1st Regiment of U.S.C.V.
 State Volunteers.

NATURE OF CASUALTY.

Died, May 15, 1864

Inventory of Effects
 forwarded to 2d
 Auditor Dec 8/68

P.

Surgeon General's Office,

Record and Pension Division,

Sept 27th, 1868.

Respectfully returned, to *the Adjutant General, U. S. Army,* with Inventory of Effects enclosed, in case of the within named man.

No evidence on file from which Final Statements can be prepared.



By Order of the Surgeon General:



J. H. Woodward
Brevet Major and Assistant Surgeon, U. S. Army.

R. of A., Vol. *14* No. *1256*

247

U.S. Cavalry
of ...
...

CASUALTY SHEET.

Name: *James Young*

Rank: *Private* Company: *"F"* Regiment: *1st*

Arm: *U.S. Cavalry* State: _____

Nature of Casualty: *Death*

CAUSE OF CASUALTY—(NAME OF DISEASE, &c.)

Measles

BY WHOM DISCHARGED.

FROM WHAT SOURCE THIS INFORMATION WAS OBTAINED.

*Mustering out Roll
Y 40567, 1864*

REMARKS.

DEGREE OF DISABILITY.

BY WHOM CERTIFIED.

*James M. Guise
2^d Lt. Condo Co.*

DATE OF DISCHARGE, DEATH, &c.

May 15 1864

PLACE OF DISCHARGE, DEATH, &c.

Bermuda Hundred, Va.

City Point, Va.

Young, Powers,
Clerk.

1341

Young Nelson

Co D, 1 U. S. Col'd Cav.
 Personal papers herein.

Private

Private

CARD NUMBERS.

1 5299326
 2 5312249
 3 5312326
 4 5312402
 5 5304568
 6 5312480
 7 5313389
 8 9086825
 9 9086697
 10 40725558
 11
 12
 13
 14
 15
 16
 17
 18
 19
 20
 21
 22
 23
 24
 25

26
 27
 28
 29
 30
 31
 32
 33
 34
 35
 36
 37
 38
 39
 40
 41
 42
 43
 44
 45
 46
 47
 48
 49
 50

Book Mark 158.406. E.B.V. 11. P. 30.

See also

Y | **1 Cav. | U.S.C.T.**

Nelson Young
 _____, Co. _____, 1 Reg't U.S. Col'd Cav.

Appears on

Company Descriptive Book

of the organization named above.

DESCRIPTION.

Age *36* years; height *5* feet *8* inches.

Complexion *light*

Eyes; *brown* hair *dark*

Where born *Norfolk Co., Va.*

Occupation *Boatman*

ENLISTMENT.

When *Jan. 28 " 64*

Where *Norfolk Va.*

By whom *J. W. Hudson*; term *3* y'rs.

Remarks: *Killed in action*
Aug. 28 " 64

Daggett

(383g)

Copyist.

Y | **1 Cav. | U.S.C.T.**

Nelson Young
 _____, Co. *B*, 1 Reg't U.S. Col'd Cav.

Appears on

Company Descriptive Book

of the organization named above.

DESCRIPTION.

Age *36* years; height *5* feet *8* inches.

Complexion *light*

Eyes; *brown* hair *dark*

Where born *Norfolk Co. Va.*

Occupation *Boatman*

ENLISTMENT.

When *Jan. 28 1864*

Where *Norfolk Va*

By whom *L. H. Hudson*; term *3* y'rs.

Remarks: *Killed in Action*
Aug. 28 1864.

(383g)

Daggett

 Copyist.

Y | **1 Cav. | U.S.C.T.**

Nelson Young
Plt

Appears with rank of on

Muster and Descriptive Roll of a Detachment of U. S. Vols. forwarded

for the 1 Reg't U. S. Col'd Cavalry. Roll dated

Camp Meade Va. July 22, 1864

Where born *Norfolk Co. Va.*

Age *36* y'rs; occupation *Boatman*

When enlisted *Jan 28, 1864*

Where enlisted *Norfolk Va.*

For what period enlisted *3* years.

Eyes *Bns*; hair *Dark*

Complexion *Lt*; height *5* ft. *8* in.

When mustered in, 186 ..

Where mustered in

Bounty paid \$ *100*; due \$ *100*

Where credited

Company to which assigned

Remarks :

Book mark :

S. H. Harris

Y. | 1 Cav. | U.S.C.T.

Nelson Young

Private, Co. I, 1 Reg't U. S. Col'd Cavalry.

Appears on

Company Muster Roll

for *Jan'y & Febr.*, 186*4*.

Present or absent *present*

Stoppage, \$ *100* for

Due Gov't, \$ *100* for

Valuation of horse, \$ *100*

Valuation of horse equipments, \$ *100*

Remarks:

.....
.....
.....
.....
.....
.....
.....
.....
.....

Book mark:

M. A. Michaels

(358)

Copyist.

U | 1 Cav. | U.S.C.T.

Nelson Young

Private, Co. I, 1 Reg't U. S. Col'd Cavalry.

Appears on

Company Muster Roll

for *March & Apr.*, 186*4*.

Present or absent *present*

Stoppage, \$ *100* for

Due Gov't, \$ *100* for

Valuation of horse, \$ *100*

Valuation of horse equipments, \$ *100*

Remarks:

Book mark: -----

M. A. Michaels

(358)

Copyist.

Y | 1 Cav. | U.S.C.T.

Nelson Young

Private, Co. I, 1 Reg't U. S. Col'd Cavalry.

Appears on

Company Muster Roll

for *May & June*, 186*4*.

Present or absent *Present*

Stoppage, \$ *100* for

Due Gov't, \$ *100* for

Valuation of horse, \$ *100*

Valuation of horse equipments, \$ *100*

Remarks:

Book mark:

M. A. Michael

(358)

Copyist.

Yl 1 Cav. | U.S.C.T.

Arlson Young
Priv. Co. I, 1 Reg't U. S. Col'd Cavalry

Appears on a

Detachment Muster Roll

of the organization named above

for May & June, 1864

Station Wilson's Landing, Va

Present or absent Present

Stoppage, \$ 100 for

Due Gov't, \$ 100 for

Valuation of horse, \$ 100

Valuation of horse equipments, \$ 100

Remarks:

Book mark:

(344)

Hammer

Copyist.

G. | 1 Cav. | U.S.C.T.

Nelson Young

Private; Co. I, 1 Reg't U. S. Col'd Cavalry.

Appears on

Company Muster Roll

for *July & Aug.*, 1864.

Present or absent

Stoppage, \$ 100 for

Due Gov't, \$ 100 for

Valuation of horse, \$ 100

Valuation of horse equipments, \$ 100

Remarks: *Killed while on a scout near Fort Pocahontas Va on the 18th of Aug. 1864. Free on or before April 19th 1864*

Book mark: *158.406*

M. A. Michaels

(358)

Copyist.

N | 1 Cav. | U.S.C.T.

Nelson Young

Par, Co. *J*, 1 Reg't U. S. Colored Cav.

Appears on Returns as follows:

Aug 18 64 Killed *Aug 18 64*
near Ft Pocahontas Va

Book mark :

W. J. Patton

(546)

Copyist.

Y. | *1 Car.* | **U. S. C. T.**

Nelson Young.

Co. I, 1 Reg't U. S. Col'd *Car.*

Appears on **Co. Muster-out Roll**, dated

Orizos Santiago Tex Feb 4, 1866.

Muster-out to date _____, 186 .

Last paid to _____, 186 .

Clothing account:

Last settled _____, 186 ; drawn since \$ _____ 100

Due soldier \$ _____ 100; due U. S. \$ _____ 100

Am't for cloth'g in kind or money adv'd \$ _____ 100

Due U. S. for arms, equipments, &c., \$ _____ 100

Bounty paid \$ _____ 100 due \$ _____ 100

Remarks: *joined as recruit.*

Killed in Skirmish Aug. 28/64, - where not known.

Book mark: *Died Aug. 18/64*

E. B. V. 11. P. 30.

Kelly,

Young, Nelson
Co. I, 1 Reg't *U.S.C. Cav*

5 Enclosures.

Bed Cards	Descriptive Lists
Burial Records	Final Statements <i>2</i>
Certs. of Dis. for Discharge	Furloughs
C. M. Charges	Med. Des. Lists
Med. Certificates	Orders

E. P. 2

Other papers relating to—

Admission to Hosp'l	Furlough
Casualty Sheet (Officer's)	Med. Examination
Confinement	Misc. Information
Contracts	Pay or Clothing
Death or Effects <i>/</i>	Personal Reports
Desertions	Rank
Discharge from Hosp'l	Transfer to Hosp'l
Discharge from Service	Transfer to V. R. C.
Duty	Transportation

NOTE 1.—This blank will be used for both enlistments and re-enlistments—enlistment of veterans, &c., &c., in the volunteer service. They will be made out in duplicate in all cases—one to accompany the recruiting return of the superintendent (not the recruiting officer) to the Adjutant General, and one to accompany the accounts of the officer who pays bounty, &c. The Regiment and Company in which the soldier last served should be given on the back.

NOTE 2.—An enlistment holds to service. A muster-in must, in all cases, precede payment of pay, bounty, pension, &c. A muster-in roll must, in all cases, be filed in the Adjutant General's Office as evidence of muster-in. The mustering officer, commissary, or assistant commissary of musters, as the case may be, will countersign both enlistments as having mustered the soldier into the service of the United States before either of them is given to the disbursing officer.

DECLARATION OF RECRUIT.

I, _____ desiring to VOLUNTEER as a Soldier in the Army of the United States, for the term of THREE YEARS, Do Declare, That I am _____ years and _____ months of age; that I have never been discharged from the United States service on account of disability or by sentence of a court-martial, or by order before the expiration of a term of enlistment; and I know of no impediment to my serving honestly and faithfully as a soldier for three years.

GIVEN at _____ the _____ day of _____

Witness: _____

No. _____

William Sperry

Volunteered at _____

25 January 1864

By *M. H. Harker*

1st Regiment of *Ad. C. C.*

_____ enlistment; last served in Company ()

_____ Reg't of _____

Discourged _____ 18 _____

CONSENT IN CASE OF MINOR.

I, _____ Do CERTIFY, That I am the _____ of _____; that the said _____ is _____ years of age; and I do hereby freely give my CONSENT to his volunteering as a SOLDIER in the ARMY OF THE UNITED STATES for the period of THREE YEARS.

GIVEN at _____ the _____ day of _____

Witness: _____

VOLUNTEER ENLISTMENT.

STATE OF

TOWN OF

Virginia



I, *Nelson Young* born in *Suffolk Co*

in the State of *Va* aged *36* years,

and by occupation a *Boatsman* Do HEREBY ACKNOWLEDGE to have

volunteered this *28th* day of *January* 186*4*

to serve as a **Soldier** in the **Army of the United States of America**, for the

period of **THREE YEARS**, unless sooner discharged by proper authority: Do also

agree to accept such bounty, pay, rations, and clothing, as are, or may be, estab-

lished by law for volunteers. And I *Nelson Young* do

solemnly swear, that I will bear true faith and allegiance to the **United States**

of America, and that I will serve them honestly and faithfully against all their

enemies or opposers whomsoever; and that I will observe and obey the orders of

the President of the United States, and the orders of the officers appointed over

me, according to the Rules and Articles of War.

Sworn and subscribed to, at *Chapel Hill*

this *28* day of *January* 186*4*,

BEFORE *Horace Hudson*

Lieut - 1st U S C Cavalry

Nelson Young
mark

I CERTIFY, ON HONOR, That I have carefully examined the above-named Volunteer, agreeably to the General Regulations of the Army, and that, in my opinion, he is free from all bodily defects and mental infirmity, which would in any way disqualify him from performing the duties of a soldier.

[Signature]
EXAMINING SURGEON.

I CERTIFY, ON HONOR, That I have minutely inspected the Volunteer, previously to his enlistment, and that he was entirely sober when enlisted; that, to the best of my judgment and belief, he is of lawful age; and that, in accepting him as duly qualified to perform the duties of an able-bodied soldier, I have strictly observed the Regulations which govern the recruiting service.

This soldier has *None* eyes, *dark* hair, *light* complexion, is *five* feet *eight* inches high.

Horace Hudson
Lieut - 1st U S C Cavalry Regiment of *U S C* Volunteers,

RECRUITING OFFICER.

(A. G. O. No. 74 & 76.)

Mustered into the service of the United States, in Company _____, Regiment of _____ Volunteers, on the _____ day of _____, 186 _____, at _____

VOLUNTEER ENLISTMENT.

STATE OF

TOWN OF

Virginia



I, *Nelson Gentry* born in *Norfolk Co*
 in the State of *Va* aged *36* years,
 and by occupation a *Boatsman* Do HEREBY ACKNOWLEDGE to have
 volunteered this *28th* day of *January* 1864,
 to serve as a **Soldier** in the **Army of the United States of America**, for the
 period of **THREE YEARS**, unless sooner discharged by proper authority: Do also
 agree to accept such bounty, pay, rations, and clothing, as are, or may be, estab-
 lished by law for volunteers. And I *Nelson Gentry* do
 solemnly swear, that I will bear true faith and allegiance to the **United States
 of America**, and that I will serve them honestly and faithfully against all their
 enemies or opposers whomsoever; and that I will observe and obey the orders of
 the President of the United States, and the orders of the officers appointed over
 me, according to the Rules and Articles of War.

Sworn and subscribed to, at *Norfolk*
 this *28* day of *January* 1864,
 BEFORE *Horace Hudson* } *Nelson Gentry*
Lieut - 1st U S Cavalry } *made*

I CERTIFY, ON HONOR, That I have carefully examined the above-named Volunteer, agreeably
 to the General Regulations of the Army, and that, in my opinion, he is free from all bodily defects and
 mental infirmity, which would in any way disqualify him from performing the duties of a soldier.

EXAMINING SURGEON.

I CERTIFY, ON HONOR, That I have minutely inspected the Volunteer,
 previously to his enlistment, and that he was entirely sober when enlisted; that, to the best of my
 judgment and belief, he is of lawful age; and that, in accepting him as duly qualified to perform the duties
 of an able-bodied soldier, I have strictly observed the Regulations which govern the recruiting service.
 This soldier has *Brown* eyes, *dark* hair, *light* complexion, is *five* feet
eight inches high.

Horace Hudson
Lieut - 1st U S Cavalry Regiment of *U. S. C.* Volunteers,

RECRUITING OFFICER.

the _____ day of _____, 1864, at _____
 Mustered into the service of the United States, in Company _____ Regiment of _____ Volunteers, on

INVENTORY OF THE EFFECTS

OF

Alson Young

Late of Company *P*

1st Reg't of *U. S. Col. Cavalry*

Volunteers, who died at *was killed at*

Capt. Pochun

on the *18th* day of *August* 186*4*



Inventory of the effects of Almon Young late
 a Private of Captain Orville Howard Company "B" of
 the 1st Regiment of U.S. Civil War Volunteers, who was enrolled as
 a Private at Ind. in the State of Indiana on
 the 25th day of February 1864, and mustered into the service of the United
 States as a Private on the 22nd day of February 1864, at Camp...
 in Company B, 1st Regiment of U.S. Civil War Volunteers, to serve 3
 years or during the war; he was born in Ind. Co. in the State
 of Indiana; he was 36 years of age, 5 feet 1 inches
 high, Fair complexion, Blue eyes, Dark hair, and by occupation, when enrolled,
 a Farmer; he died in Ind. Co. at
Fort Reservoir on the 18th day of August 1864, by
 reason of ...

INVENTORY.					
ARTICLES.	No.	ARTICLES.	No.	ARTICLES.	No.
Hats		Pairs trousers		Knapsacks	
Caps		Pairs flannel drawers			
Forage caps		Pairs cotton drawers			
Great coats	1	Flannel shirts			
Uniform coats		Cotton shirts			
Uniform jackets	1	Pairs boots			
Flannel sack coats		Pairs shoes			
Blouses		Pairs socks			
Stable frocks		Blankets			
Fatigue overalls		Haversacks			
				MONEY.	
				Specie	\$
				Notes	\$

I CERTIFY, ON HONOR, that the above inventory comprises all the effects of Almon Young
 deceased, and that the effects are in the hands
 of Orville Howard at Fort Reservoir
Ind. to be disposed of by a Council of Administration.

(DUPLICATES.)

STATION: Fort Reservoir, Ind.

DATE: August 18th 1864

Orville Howard
 Captain
 Commanding the Company.

FINAL STATEMENT

OF

Thompson Co. "F"
14th Reg't of U. S. Col. Cavalry

VOLUNTEERS.

NOTE 1.—Two of these certificates (or duplicates) are to be given to each Volunteer Soldier or drafted man who may be discharged previously to the discharge of his company, that he may at once receive from the Paymaster the pay, &c., due him, and the captain or other COMMISSIONED officer commanding the company will certify to the act of the delivery of the duplicate certificates; on these certificates the Soldier is "entitled to" his discharge, and should also present his discharge to the Paymaster to have the payment endorsed on it. The discharge is to be given back to the Soldier by the Paymaster; the latter only retaining as his voucher the duplicate certificates.

NOTE 2.—If the Soldier is entitled to pay for the use of his horse, the Company Commander will certify to that fact on the back of both these final statements, and also to the time he has pay due for having been so mounted on his own horse.

NOTE 3.—When a Soldier is furnished with final statements, his descriptive list, if he has one, should be taken up by the officer who gives the Soldier these statements, and endorsed with a statement to this effect by the officer. This endorsement should exhibit a full statement of the time for which the Soldier was allowed pay on his final statements, the clothing account, and all other charges against him or in his favor, so as to comprise a complete exhibit of his account. It will then be transmitted to the company commander of the Soldier, who will enter all the data necessary to a full understanding of the Soldier's account on the muster roll upon which the Soldier's discharge is reported. The descriptive list will then be destroyed. The object of this is, that the remaining portion of the Soldier's account may be settled upon the receipt of these muster rolls, and the Soldier receive any pay or allowances that may be due him at the time of his discharge, and which may not appear on his final statements from the fact that his descriptive list is incomplete. These accounts for back pay, &c., are settled by the 2d Auditor of the Treasury Department.

NOTE 4.—Charges for loss or injury to ordnance, horse equipments, and other miscellaneous charges, should appear under the heading of "Other Stoppages."

NOTE 5.—Bounty paid by State authorities, and not by the United States, will not be entered on this statement.

NOTE 6.—Amounts due the Sutler and Laundress must be entered on the muster roll on which the discharge, death, desertion, &c., is reported, as well as on the final statement, otherwise the amount cannot be collected from the United States.

NOTE 7.—This blank will be used for deceased volunteers and drafted men, as well as for others.

NOTE 8.—Where a Soldier dies in Hospital or on detached service, his descriptive list, if he has one, should be sent with his final statements, in duplicate, to the Adjutant General, Washington, D. C.

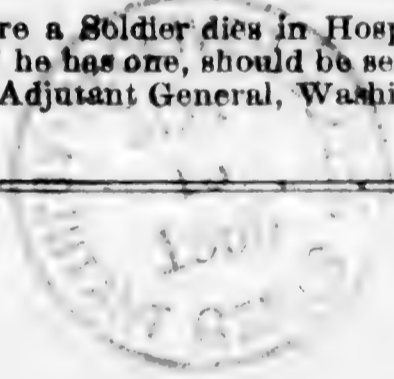

I certify, on honor, that Alson Young a Private of
 Captain Orlando Thomas Company (I) of the 1st Regiment of U.S. Col'd Cavalry
VOLUNTEERS, of the State of Virginia, born in Port Republic Co, State
 of Virginia, aged 30 years; 5 feet 8 inches high; Light complexion,
Blue eyes, Dark hair, and by occupation a Boatman having joined the company on
~~its original organization at~~ Port Republic and enrolled in it at the muster into
 the service of the United States at Port Republic, on the 12 day
 of February, 1864, (or was mustered in service as a recruit, by Capt. O. Thomas
at Port Republic on the 12th day of February,
 1864, or was drafted and mustered into the service of the United States from the 0
 Enrollment District of the State of Virginia, at Port Republic,
 on the 12 day of February, 1864) to serve in the Regiment, for
 the term of 3 years: and having served **HONESTLY** and
FAITHFULLY with his Company in the field to the present date, is now

entitled to a **DISCHARGE** by reason of Disability, Keck's Act, 1864
18th Feb 4 Port Republic James River

The said Alson Young was last paid by Paymaster
Wm H. ... to include the 1 day of February, 1864, and has
 pay due him from that time to the present date; he is entitled to pay and subsistence for
TRAVELING to place of enrollment, and whatever other allowances are authorized to volunteer
 soldiers, drafted men, or militia, so discharged. He has received from the United States **CLOTHING**
 amounting to 45¹³/₁₀₀ dollars, since the 2nd day of February,
 1864, when his clothing account was last settled. He has received from the United States
0⁰⁰/₁₀₀ dollars advanced **BOUNTY**.

There is to be stopped from him, on account of the State of Virginia, or other
 authorities, for **CLOTHING**, &c., received on entering service, 28⁴⁰/₁₀₀ dollars; and
 for other stoppages, viz: Sh. Ct.

0⁰⁰/₁₀₀ dollars.

He has been furnished with **TRANSPORTATION** in kind from the place of his discharge to
Port Republic; and he has been **SUBSISTED** for **TRAVELING** to his
 place of enrollment, up to the 12 day of February, 1864.

He is indebted to Capt. O. Thomas, **SUTLER**, 2⁰⁰/₁₀₀ dollars.
 He is indebted to ..., **LAUNDRESS**, 0⁰⁰/₁₀₀ dollars.

Given in Duplicate, at Port Republic James River this 18th day
 of February, 1864.

Orlando Thomas
Commanding Company.

[OFFICE INDORSEMENT.]

War Department,

ADJUTANT GENERAL'S OFFICE.

March 23, 1871.

The _____ of _____
 _____ Co. _____ Reg't U. S.
 Colored _____, is reported as follows:—

On Company Muster Roll.
 For _____, 186 _____, 186.
 Company Muster-out Roll.
 _____, 186.
 Company Descriptive Book.
 _____, 186
 Company Morning Reports.
 _____, 186
 Soldier's Final Statement.
 _____, 186
 Soldier's Record of Death and Interment.
 _____, 186
 Soldier's Inventory of Effects.
 _____, 186
 Soldier's Certificate of Disability for Discharge.
 _____, 186
 Soldier's Individual Muster-out Roll.
 _____, 186
 Regimental Return.
 For _____, 186 _____, 186
 Regimental Quarterly Returns.
 _____, 186
 Regimental Descriptive Book.
 _____, 186
 By Surgeon General.
 _____, 186

Aug 18, 1864 is held to be
 the correct date, and the Company Muster Roll
 Roll will be amended accordingly.

Thoma D. ...
see letter Asst. Adj. Gen.
to 2nd and May 4. 71
based on ...

FINAL STATEMENT

OF

1st Reg't of U.S.A.
Reg't of ...

VOLUNTEERS.

NOTE 1.—Two of these certificates (or duplicates) are to be given to each Volunteer Soldier or drafted man who may be discharged previously to the discharge of his company, that he may at once receive from the Paymaster the pay, &c., due him, and the captain or other COMMISSIONED officer commanding the company will certify to the act of the delivery of the duplicate certificates; on these certificates the Soldier is "entitled to" his discharge, and should also present his discharge to the Paymaster to have the discharge endorsed on it. The discharge is to be given back to the Soldier by the Paymaster; the latter only retaining as his voucher the duplicate certificates.

NOTE 2.—If the Soldier is entitled to pay for the use of his horse, the Company Commander will certify to that fact on the back of both these final statements, and also to the time he has pay due for having been so mounted on his own horse.

NOTE 3.—When a Soldier is furnished with final statements, his descriptive list, if he has one, should be taken up by the officer who gives the Soldier these statements, and endorsed with a statement to this effect by the officer. This endorsement should exhibit a full statement of the time for which the Soldier was allowed pay on his final statements, the clothing account, and all other charges against him or in his favor, so as to comprise a complete exhibit of his account. It will then be transmitted to the company commander of the Soldier, who will enter all the data necessary to a full understanding of the Soldier's account on the muster roll upon which the Soldier's discharge is reported. The descriptive list will then be destroyed. The object of this is, that the remaining portion of the Soldier's account may be settled upon the receipt of these muster rolls, and the Soldier receive any pay or allowances that may be due him at the time of his discharge, and which may not appear on his final statements from the fact that his descriptive list is incomplete. These accounts for back pay, &c., are settled by the 2d Auditor of the Treasury Department.

NOTE 4.—Charges for loss or injury to ordnance, horse equipments, and other miscellaneous charges, should appear under the heading of "Other Stoppages."

NOTE 5.—Bounty paid by State authorities, and not by the United States, will not be entered on this statement.

NOTE 6.—Amounts due the Sutler and Laundress must be entered on the muster roll on which the discharge, death, desertion, &c., is reported, as well as on the final statement, otherwise the amount cannot be collected from the United States.

NOTE 7.—This blank will be used for deceased volunteers and drafted men, as well as for others.

NOTE 8.—Where a Soldier dies in Hospital or on detached service, his descriptive list, if he has one, should be sent with his final statements, in duplicate, to the Adjutant General, Washington, D. C.

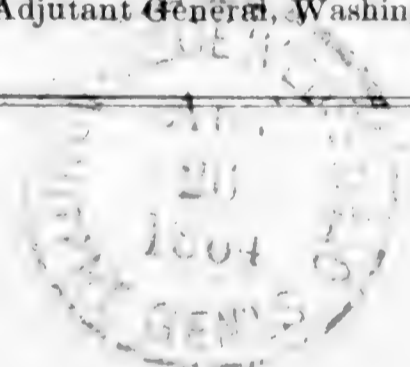

I certify, on honor, that Mason L. Horn a Private of
 Captain Mills Horn Company (D) of the 1st Regiment of U. S. Civil Cavalry
VOLUNTEERS, of the State of Virginia, born in Frank Co, State
 of Virginia, aged 36 years; 5 feet 8 inches high; light complexion.
Brown eyes, dark hair, and by occupation a Blacksmith having joined the company on
 its original organization at the 28th of January 1864 enrolled in it at the muster into
 the service of the United States at Frank Co, on the 1 day
 of February, 1864 (or was mustered in service as a recruit, by Capt. T. Martin
Camp on the 22nd day of February
 1864, or was drafted and mustered into the service of the United States from the
 Enrollment District of the State of Virginia, at Frank Co,
 on the 1 day of February, 1864) to serve in the Regiment, for
 the term of 3 years and having served **HONESTLY** and
FAITHFULLY with his Company in in the field to the present date, is now
 entitled to a **DISCHARGE** by reason of death. Killed August
18th 1864 at Fort Beaumont James River Va

The said Mason L. Horn was last paid by Paymaster
unpaid to include the 1 day of February, 1864, and has
 pay due him from that time to the present date; he is entitled to pay and subsistence for
TRAVELING to place of enrollment, and whatever other allowances are authorized to volunteer
 soldiers, drafted men, or militia, so discharged. He has received from the United States **CLOTHING**
 amounting to 47 ¹⁵/₁₀₀ dollars, since the 28th day of January,
 1864, when his clothing account was last settled. He has received from the United States
100 dollars advanced **BOUNTY**.

There is to be stopped from him, on account of the State of Virginia, or other
 authorities, for **CLOTHING**, &c., received on entering service, 23 ⁹⁶/₁₀₀ dollars; and
 for other stoppages, viz 1.01

..... 100 dollars.
 He has been furnished with **TRANSPORTATION** in kind from the place of his discharge to
; and he has been **SUBSISTED** for **TRAVELING** to his
 place of enrollment, up to the 1 day of February, 1864.

He is indebted to C. B. Post, **SUTLER**, 2 ⁰⁰/₁₀₀ dollars.
 He is indebted to, **LAUNDRESS**, ⁰⁰/₁₀₀ dollars.

Given in Duplicate, at Fort Beaumont James River Va the 18th day
 of August, 1864.

Mills Horn
Captain
 Commanding Company.

1342

Young, Randolph
Co A, 1 U. S. Col'd Cav.

Private Private

CARD NUMBERS.

1	5299467	26
2	5311107	27
3	5311203	28
4	5311199	29
5	5311309	30
6	5311413	31
7	5311517	32
8	5311618	33
9	5311722	34
10	5311822	35
11	5311922	36
12	5312017	37
13	9086601	38
14	8276-RCY-1868	39
15	4072-5559	40
16		41
17		42
18		43
19		44
20		45
21		46
22		47
23		48
24		49
25		50

Book Mark S. 276. Vol. 5. R.L.T. 1868.

See also

Y. | *1 Cav.* | **U.S.C.T.**

Randolph Young,

, Co. *H*, | *1* Reg't U. S. Col'd *Caval.*

Appears on

Company Descriptive Book

of the organization named above.

DESCRIPTION.

Age *23* years; height *5* feet..... inches.

Complexion *Black.*

Eyes *Black*; hair *Black.*

Where born *Smithfield Mass.*

Occupation

ENLISTMENT.

When *Aug. 24/64*, 18*64* .

Where *Norfolk*

By whom *L. Horton*; term *3* y'rs.

Remarks:

.....

Dickerson

Y. | **1 Cav. | U.S.C.T.**

George Young

Appears with rank of *Priv.* on

Muster and Descriptive Roll of a Detachment of U. S. Vols. forwarded

for the 1 Reg't U. S. Col'd Cavalry. Roll dated

Newport News Va Aug 31, 1864.

Where born *Smithfield Mass.*

Age *20* y'rs; occupation *Labourer*

When enlisted *August*, 1864

Where enlisted *Newport*

For what period enlisted *3* years.

Eyes *Black*; hair *Black*

Complexion *Dun*; height *5* ft. *8* in.

When mustered in *Aug 25*, 1864.

Where mustered in *Newport News*

Bounty paid \$ *100*; due \$ *100*

Where credited *Newport News*

Company to which assigned *()*

Remarks :

Book mark :-----

(339)

George Young
Copyist.

1 Cav. U.S.C.T.

James H. ...

..., Co. H, 1 Reg't U. S. Col'd Cavalry.

Appears on

Company Muster Roll

for *June 9*, 186*7*.

Present or absent *Present*

Stoppage, \$ *100* for

Due Gov't, \$ *100* for

Valuation of horse, \$ *100*

Valuation of horse equipments, \$ *100*

Remarks:

*Rec'd ...
...
...
...*

Book mark:

(358)

James H. ...

Copyist.

Y | 1 Cav. | U.S.C.T.

Randolph Young

Recruit Co. H, 1 Reg't U. S. Col'd Cavalry.

Appears on

Company Muster Roll

for *Sept - Oct*, 186*4*

Present or absent

Stoppage, \$ 100 for

Due Gov't, \$ 100 for

Valuation of horse, \$ 100

Valuation of horse equipments, \$ 100

Remarks: *Deserted from
Co Sept 13th*

Book mark:

(358)

M Jackson
Copyist.

Y

1 Cav. U.S.C.T.

Randolph Young

Priv, Co. H, 1 Reg't U. S. Col'd Cavalry.

Appears on

Company Muster Roll

for *Sept - Dec*, 186*4*.

Present or absent *Absent*

Stoppage, \$ *100* for

Due Gov't, \$ *100* for

Valuation of horse, \$ *100*

Valuation of horse equipments, \$ *100*

Remarks: *Deserted Sept 15"
1864 - recaptured
Sept 17"/64 - Absent
in Confinement
awaiting sentence
of G.C.M.*

Book mark:

(358)

M Jackson

Copyist.

14 | 1 Cav. | U.S.C.T.

Randolph Young

Priv., Co. H, 1 Reg't U. S. Col'd Cavalry.

Appears on

Company Muster Roll

for Nov & Dec, 1864

Present or absent Absent

Stoppage, \$ 100 for

Due Gov't, \$ 100 for

Valuation of horse, \$ 100

Valuation of horse equipments, \$ 100

Remarks: Absent under arrest at Norfolk Va. Awaiting sentence Court Martial

Book mark:

(358)

M. Jackson Copyist.

G | 1 Cav. | U.S.C.T.

Randolph Young
Cot, Co. H, 1 Reg't U. S. Col'd Cavalry.

Appears on

Company Muster Roll

for *Jan & Feb*, 1865.

Present or absent *Absent*

Stoppage, \$ *100* for

Due Gov't, \$ *100* for

Valuation of horse, \$ *100*

Valuation of horse equipments, \$ *100*

Remarks *Absent under arrest at Norfolk Va for desertion*

Book mark:

(358)

M Jackson

Copyist.

G | 1 Cav. | U.S.C.T.

Randolph Young
Priv, Co. H, 1 Reg't U. S. Col'd Cavalry.

Appears on

Company Muster Roll

for *Month of April*, 186 *5*.

Present or absent *Absent*

Stoppage, \$ *100* for

Due Gov't, \$ *100* for

Valuation of horse, \$ *100*

Valuation of horse equipments, \$ *100*

Remarks: *Absent under arrest at Marpoh Va for desertion*

Book mark:

(358)

Jackson
Copyist.

W. V. Law | U.S.C.T.

Randolph Young
Capt, Co. I, Reg't U. S. Col'd Cal

Appears on

Company Muster Roll

for *May June*, 1867.

Present or absent *Absent*

Stoppage, \$ 100 for

Due Gov't, \$ 100 for

Valuation of horse, \$ 100

Valuation of horse equipments, \$ 100

Remarks: *Absent under arrest at Norfolk Va for desertion*

Book mark:

(358)

W. Jackson
Copyist.

24 | 1 Cav. | U.S.C.T.

Randolph Young

Priv, Co. H, 1 Reg't U. S. Col'd Cavalry.

Appears on

Company Muster Roll

for July & Aug, 1865.

Present or absent Absent

Stoppage, \$ 100 for

Due Gov't, \$ 100 for

Valuation of horse, \$ 100

Valuation of horse equipments, \$ 100

Remarks: Absent in
Confinement at
Norfolk Va for
desertion

Book mark:

(358)

O. Jackson
Copyist.

Y 1 bar | U.S.C.T

Randolph Young
Priv, Co. H, 1 Reg't U. S. Col'd *Bar*

Appears on

Company Muster Roll

for *Sept + Oct*, 1865.

Present or absent *absent*

Stoppage, \$ *100* for

Due Gov't, \$ *100* for

Valuation of horse, \$ *100*

Valuation of horse equipments, \$ *100*

Remarks: *Confinement*
Marshall jail.

Book mark:

(358)

Pepper
copyist Copyist.

Y / bar U.S.C.T

Randolph Young

Priv, Co. H, 1 Reg't U. S. Col'd bar

Appears on

Company Muster Roll

for Nov + Dec, 1865?

Present or absent absent

Stoppage, \$ 100 for

Due Gov't, \$ 100 for

Valuation of horse, \$ 100

Valuation of horse equipments, \$ 100

Remarks: In confinement at Norfolk City Jail

Book mark:

Remmes
A. D. W. J. Copyists

(353)

Y. | 1 Cav. | U.S.C.T.

Randolph Young

Prvt, Co. H., 1 Reg't U. S. Colored Cav.

Appears on Returns as follows:

Aug 1864 Aug 26. N. New
 Return from Depot
 Absent Aug 27.
 Retained Aug 31.

Oct to Dec 1864 absent in Court
 at Norfolk Va awaiting
 sentence for desertion.
 Jan + Feby 1865: absent Norfolk
 Va awaiting trial for
 desertion.
 Mch to July 1865 - absent under
 arrest at Norfolk Va
 for desertion
 Aug to Oct 1865. absent in Con-
 finement at Norfolk Va
 Nov 1865 to Jan 1866 absent
 under arrest Norfolk Va

Book mark:

Wm. Carter

Y | **1 Cav. | U.S.C.T.**

Randolph Young

Pt, Co. *K*, 1 Reg't U. S. Col'd Cavalry.

Appears on **Co. Muster-out Roll**, dated

Brazos Santiago Tex, Feb 4, 1866.

Muster-out to date _____, 186 .

Last paid to *Dec 31*, 1864 .

Clothing account:

Last settled _____, 186 ; drawn since \$ _____ $\overline{100}$

Due soldier \$ _____ $\overline{100}$; due U. S. \$ _____ $\overline{100}$

Am't for cloth'g in kind or money adv'd \$ _____ $\overline{100}$

Due U. S. for arms, equipments, &c., \$ _____ $\overline{100}$

Bounty paid \$ *100* $\overline{100}$ ^{*00*}; due \$ *none* $\overline{100}$

Remarks: *Joined as Rec't*
Deserted at Newport News
Va. Aug 26/64 Retaken
Aug 31/64 & confined in
Jail Norfolk Va.

Book mark: *S 276 vol. 5 R. 62, 1868*

J. H. Stewart

Y | *1st Cav* | *U.S.C.S.*

Randolph Young

, Co. . . . , *1st Reg't* *U.S.C.S.*
Cav.

NOTATION.

Book mark: *S-276-R-6-J-1868.*

War Department,

Adjutant General's Office,

Washington, *July 22, 1868.*

Call from

returned with report.

The above book mark was noted on rolls in order to
preserve results of search in this case.

W. Allen

(475)

Copyist.

Young Randolph

1st Lt 1156 Co
 , Co. _____, Reg't _____

5 Enclosures.

Bed Cards	Final Statements
Burial Records	Furloughs or L. of A.
Certs. of Dis. for Discharge	Med. Certificates
C. M. Charges	Med. Des. Lists
Descriptive Lists	Orders
Discharge Certificates	Pris. of War Record
Enlistment Papers	Resignations

Other papers relating to—

Admission to Hosp'l	Furlough or L. of A.
Casualty Sheet	Med. Examination
Confinement	Misc. Information <i>34</i>
Contracts	Pay or Clothing
Death or Effects	Personal Reports
Desertion	Rank
Discharge from Hosp'l	Transfer to Hosp'l
Discharge from Service	Transfer to V. R. C.
Duty	Transportation

MICROFILM PUBLICATION M 1817

COMPILED MILITARY SERVICE RECORDS
OF VOLUNTEER UNION SOLDIERS WHO
SERVED WITH THE USCT (US COLORED TROOPS)
1ST REGIMENT OF CAVALRY

PERSONAL PAPERS' TARGET SHEET

PLEASE NOTE THE CHECKED INFORMATION ABOUT THE PERSONAL PAPERS IN
THIS FILE:

- NO PERSONAL PAPERS WERE FOUND IN THIS FILE WHEN THE
RECORDS WERE ARRANGED FOR MICROFILMING.
- 6 PERSONAL PAPER(S) FOUND IN THIS FILE WHEN THE RECORDS
WERE ARRANGED FOR MICROFILMING.

NOTE 1.—This blank will be used for both enlistments and re-enlistments—enlistment of veterans, &c., &c., in the volunteer service. They will be made out in duplicate in all cases—one to accompany the recruiting return of the superintendent (not the recruiting officer) to the Adjutant-General, and one to accompany the accounts of the officer who pays bounty, &c. The Regiment and Company in which the soldier last served should be given on the back.

NOTE 2.—An enlistment holds to service. A muster-in must, in all cases, precede payment of pay, bounty, pension, &c. A muster-in roll must, in all cases, be filed in the Adjutant-General's Office as evidence of muster-in. The mustering officer, commissary, or assistant-commissary of musters, as the case may be, will countersign both enlistments as having mustered the soldier into the service of the United States before either of them is given to the disbursing officer.

DECLARATION OF RECRUIT.

I, *Randolph Young* desiring to VOLUNTEER as a Soldier in the Army of the United States, for the term of THREE YEARS, Do Declare, That I am *twenty* years and _____ months of age; that I have never been discharged from the United States service on account of disability or by sentence of a court-martial, or by order before the expiration of a term of enlistment; and I know of no impediment to my serving honestly and faithfully as a soldier for three years.

GIVEN at *Norfolk Va* the *24* day of *August 1864*

Witness: *CH Brewster* *Randolph Young*

No. *46*

Randolph Young

Volunteered at *Norfolk Va*

August 24 18*64*,

By *Genl J M Winton*

38th Regiment of A S C G

enlistment; last served in Company ()

Regt of

Discharged

18

CONSENT IN CASE OF MINOR.

I, _____ Do CERTIFY, That I am _____; that the _____ years of age; and I do hereby freely give my CONSENT to his volunteering as a SOLDIER in the ARMY OF THE UNITED STATES, for the period of THREE YEARS.

GIVEN at _____ the _____ day of _____

Witness: _____

VOLUNTEER ENLISTMENT.

STATE OF

TOWN OF

Mass

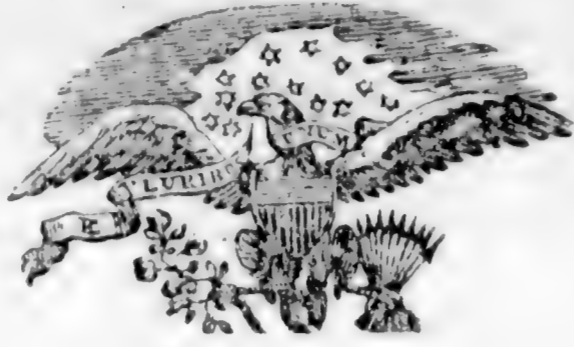

Or large

I, *Randolph Young* born in *Smithfield*
 in the State of *Massachusetts* aged *twenty* years,
 and by occupation a *labourer* Do HEREBY ACKNOWLEDGE to have
 volunteered this *twenty fourth* day of *August* 1864,
 to serve as a **Soldier** in the **Army** of the **United States of America**, for the
 period of **THREE YEARS**, unless sooner discharged by proper authority: Do also
 agree to accept such bounty, pay, rations, and clothing, as are, or may be, estab-
 lished by law for volunteers. And I, *Randolph Young* do
 solemnly swear, that I will bear true faith and allegiance to the **United States**
of America, and that I will serve them honestly and faithfully against all their
 enemies or opposers whomsoever; and that I will observe and obey the orders of
 the President of the United States, and the orders of the officers appointed over
 me, according to the Rules and Articles of War.

Sworn and subscribed to, at *Norfolk Va*
 this *24* day of *August* 1864, *Randolph Young*
 BEFORE *J. A. [Signature]* *mark*
Sent & Recruiting Officer

I CERTIFY, ON HONOR, That I have carefully examined the above-named Volunteer, agreeably
 to the General Regulations of the Army, and that, in my opinion, he is free from all bodily defects and
 mental infirmity, which would in any way disqualify him from performing the duties of a soldier.

W. H. [Signature]
Sur. Surg. [Signature]
 EXAMINING SURGEON.

I CERTIFY, ON HONOR, That I have minutely inspected the Volunteer,
 previously to his enlistment, and that he was entirely sober when enlisted; that, to the best of my
 judgment and belief, he is of lawful age; and that, in accepting him as duly qualified to perform the duties
 of an able-bodied soldier, I have strictly observed the Regulations which govern the recruiting service,
 This soldier has *black* eyes, *black* hair, *dark* complexion, is *5* feet
3 inches high.

J. A. [Signature]
38th Regiment of *USCG* Volunteers,
Sent & RECRUITING OFFICER.

(A. G. O. No. 74 & 75.)

Mustered into the service of the United States, in Company *[Signature]*, *1st* Regiment of *USCG* Volunteers, on
 the *25* day of *August*, 1864, at *Norfolk Va*
[Signature] *Major or Surgeon*
[Signature] *Sur. Surg.*
[Signature] *Volunteer*
[Signature] *Volunteer*
[Signature] *Volunteer*

Hard Labor Prison
OFFICE PROVOST MARSHAL,
DISTRICT OF EASTERN VIRGINIA.

NORFOLK, VA., 24th Jan'y 1865.

Lt. Col. O. L. Mann.

Provost Marshal. Dist. Eastern Virginia.

Randolph Young

1st No S. C. Cav.

Received.

Provost Marshal's Office,

Head Quarters District of Eastern Virginia,

Norfolk, Va., Jan. 24th 1865.Capt. A. B. Nichol,
Capt. Pison Laborer

Captain;

The Brig. Genl.

Commanding directs, - in pursuance of
orders from Head Quarters Department -
that the execution of Private Randolph
Young 1st U.S. Cavalry (Col'd), be suspended
until further orders

Very Respectfully

Your Obedt. Servt.

O. S. Munn

A. Col. (and) Provost Marshal

Dist. E. Va.

U. S. Dist. Ct. Virginia
Norfolk, Va. Jan. 24th 1865.

Order that the execution
of Private Randolph Young
13th U. S. Col. be ~~to~~ be
suspended until further orders.

28-22-20-95

Private Randolph Young
13th U. S. Col. Cavalry
No. 28-22-20-95
for execution

Head Quarters District Eastern Va
 Norfolk Va January 21st 1865.

Sir
 Lieut Col C. S. Mann
 Court Marshal

Col
 The Brig Genl Comdg
 directs in pursuance of orders from Head Quarters
 Department that the execution of Private Randolph
 Young 1st West Cavalry (Col'd), be suspended until
 further orders.

I am, Sir,

Your Obedt Servant
 Wickham Hoffman
 A. A. Genl

Hd Quarters Dist Col
Jan 24th 1865

C. O. C. Ord
Maj Genl Comdg

directs that the execution
of death upon Priv Randolph
young be suspended at
present,

~~of the~~

filed 12-26-95

W. H.

United States Military Telegraph.

By Telegraph from W. D. East Va.

Dated Jan. 24 1865.

To Gen. Shiple

or to Comdg Officer.

Suspend the execution
of sentence of death
of private Randolph
Young, 1st U.S. C. Cav.,
who was to be executed
tomorrow.

E. O. C. Ord

Maj-Gen. Comd

Acknowledge receipt of this

(Wrappers)
J. A. S. v. M. in 1865
M. A. S. v. Dept. of Va
J. A. S. v. M. in 1865
J. A. S. v. M. in 1865

Genl. E. C. C.
Major Genl. Co. Va.

Notes in relation to case
of Genl. Randolph Young
(old) - Desires if practi-
-cally to review the papers
in his case - - -

Copy of Pro. Martial Code Dept. of Va
J. A. S. v. M. in 1865
Respectfully returned to Major
Genl. E. C. C. Va. Dept. of Va.
I am more reasonable
tho' man should not be shot,
he having been found guilty
of deserting three times, and
U. S. Army

of having enlisted into two
different Regiments while
belonging to the 1st U. S. Colored
Troop -

The proceedings in
his case have been forwarded
to Washington by the Judge
Advocate of the Dept.

The sentence of this
man is published in Genl.
Coul's Martial Orders, No
3, Jan 3rd 1865 -

John Boughton
Genl. Co. of Pro. Martial
Dept. of Va

James V. H. 1865
 Md. Des. Dept of Va
 Dep. Monroe Va
 May 25 65

Comd. S. C. Co.
 Major's sub Comd
 627 (Hagerman) W. Va.

Writes in relation to case
 of Pri. David A. J. Young
 (Cold) - Desires if practi-
 -cable to review the papers
 in his Case - - -

RECEIVED
 U.S. DEPT. OF COMMERCE
 JUN 22, 1865
 Ft. Monroe, Va.

to make the inquiry
and examine the man
reporting to me the circum-
stances - should the
proceedings of the court be
within reach I would like
to know them -

Yours - E O Cord

May 24 1893

Cord

NARRAI 1994

Off. Pro. Mar. Dist. E. Va.,
Norfolk, Va., Jan. 27/68.

Respectfully returned to
Col. Conghlin. Upon ap-
plication to Maj. Hen-
nessy, Judge Advocate,

I learn that the proceed-
ings of the Court in the
Case of the within named
Private Randolph Young
can be obtained only at
Department Hd Qrs.

Q. S. Munn

Lt. Col. @ Pro. Marshal,
Dist. E. Va.

MAR 1985

1542 - Randolph Young

Warranted 3x & was to be
shot. Execution suspended
for further review since colored
troops had fought so well

1543

Young William
Co D, 1 U. S. Col'd Cav.

Private

Private

CARD NUMBERS.

1	5312100	26
2	5312172	27
3	5312247	28
4	5312324	29
5	5312401	30
6	5300567	31
7	5312475	32
8	5312567	33
9	5312672	34
10	5312781	35
11	5312885	36
12	5312984	37
13	5313084	38
14	5313179	39
15	5313270	40
16	5313362	41
17	R. P. 44614	42
18	9086876	43
19	9086689	44
20		45
21		46
22		47
23		48
24		49
25		50

Book Mark: 44614. R. P. D. 1889.

See also

Y | **1 Cav. | U.S.C.T.**

William Young

....., Co. *F*, 1 Reg't U.S. Col'd Cav.

Appears on

Company Descriptive Book

of the organization named above.

DESCRIPTION.

Age *40* years; height *5* feet *5* inches.

Complexion *light*

Eyes; *Brown* hair *Dark*

Where born *Norfolk Co., Va.*

Occupation *Farmer*

ENLISTMENT.

When *Dec. 9" 1863*

Where *Norfolk*

By whom *Capt. Brown*; term *3* y'rs.

Remarks:

.....

Daygett

2. | **1 Cav. | U.S.C.T.**

William Young

....., Co. D., 1 Reg't U.S. Col'd Cav.

Appears on

Company Descriptive Book

of the organization named above.

DESCRIPTION.

Age 170 years; height 5 feet 5 inches.

Complexion light

Eyes; brown hair dark

Where born Norfolk Co., Va.

Occupation Farmer

ENLISTMENT.

When Dec. 9th 1863

Where Norfolk, Va.

By whom Capt. A. Brown; term 3 y'rs.

Remarks:

.....

.....

.....

.....

.....

.....

.....

.....

.....

.....

W. Young

C | **1 Cav.** | **U.S.C.T.**

William Young

Private, Co. *A*, 1 Reg't U. S. Col'd Cavalry.

Age *40* years.

Appears on

Company Muster-in Roll

of the organization named above. Roll dated

Camp Hamilton Va, Dec. 22, 1863.

Muster-in to date *Dec. 22, 1863.*

Joined for duty and enrolled:

When *Dec. 9th*, 1863.

Where *Norfolk Va.*

Period *3* years.

Valuation of horse, \$.....100

Valuation of horse equipments, \$.....100

Remarks:

.....

.....

.....

Book mark: *44614-R.P.D-1889*

M.A. Michael

(356)

Copyist.

W. | **1 Cav. | U.S.C.T.**

William Young
Private, Co. I, 1 Reg't U. S. Col'd Cavalry.

Appears on

Company Muster Roll

for *Dec. 22 to 31st*, 1863.

Present or absent *present*

Stoppage, \$ 100 for

Due Gov't, \$ 100 for

Valuation of horse, \$ 100

Valuation of horse equipments, \$ 100

Remarks:

Book mark:

M. A. Michaels

(358)

Copyist.

U | 1 Cav. | U.S.C.T.

William Young
Private, Co. I, 1 Reg't U. S. Col'd Cavalry.

Appears on

Company Muster Roll

for *Jan'y & Feb.*, 186*4*.

Present or absent *present*.

Stoppage, \$ *100* for

Due Gov't, \$ *100* for

Valuation of horse, \$ *100*

Valuation of horse equipments, \$ *100*

Remarks:

Book mark: -----

(M.A. Michaels)

(358)

Copyist.

4 | 1 Cav. | U.S.C.T.

William Young
Private, Co. I, 1 Reg't U. S. Col'd Cavalry.

Appears on

Company Muster Roll

for *March & Apr*, 186 *4*

Present or absent *present*

Stoppage, \$ 100 for

Due Gov't, \$ 100 for

Valuation of horse, \$ 100

Valuation of horse equipments, \$ 100

Remarks:

Book mark:

M. A. Michaels

(358)

Copyist.

4 | 1 Cav. | U.S.C.T.

William Young

Private, Co. I, 1 Reg't U. S. Col'd Cavalry.

Appears on

Company Muster Roll

for *May & June*, 186 *4*.

Present or absent *present*

Stoppage, \$ *100* for

Due Gov't, \$ *100* for

Valuation of horse, \$ *100*

Valuation of horse equipments, \$ *100*

Remarks:

Book mark:

M. A. Michael

(358)

Copyist.

Yl 1 Cav. U.S.C.T.

William Young
Pvt, Co. D, 1 Reg't U. S. Col'd Cavalry

Appears on a

Detachment Muster Roll

of the organization named above

for May & June, 1864.

Station Wilson's Landing, Va

Present or absent Present

Stoppage, \$ 100 for

Due Gov't, \$ 100 for

Valuation of horse, \$ 100

Valuation of horse equipments, \$ 100

Remarks:

Book mark:

(344)

Hammer

Copyist.

Y | 1 Cav. | U.S.C.T.

William Young

Private, Co. I, 1 Reg't U. S. Col'd Cavalry.

Appears on

Company Muster Roll

for *July & Aug.*, 186*4*.

Present or absent *present*

Stoppage, \$ *100* for

Due Gov't, \$ *100* for

Valuation of horse, \$ *100*

Valuation of horse equipments, \$ *100*

Remarks: *free on or before
April 10th 1861.*

Book mark:

M. A. Michaels

(358)

Copyist.

4 | 1 Cav. | U.S.C.T.

William Young

Mr., Co. I, 1 Reg't U. S. Col'd Cavalry.

Appears on

Company Muster Roll

for Sept & Oct, 1864

Present or absent Present

Stoppage, \$ 100 for

Due Gov't, \$ 100 for

Valuation of horse, \$ 100

Valuation of horse equipments, \$ 100

Remarks: To be stopped from his pay for advance cert #190

Book mark:

Copyist

Y | 1 Cav. | U.S.C.T.

William Young

Pr, Co. I, 1 Reg't U. S. Col'd Cavalry.

Appears on

Company Muster Roll

for *Nov & Dec*, 186 *X*

Present or absent *Present*

Stoppage, \$ *100* for

Due Gov't, \$ *100* for

Valuation of horse, \$ *100*

Valuation of horse equipments, \$ *100*

Remarks: *Due US for Advances*
A. 1.90

Book mark:

Cutter
Copyist.

G | 1 Cav. | U.S.C.T.

William Young

Priv, Co. I, 1 Reg't U. S. Col'd Cavalry.

Appears on

Company Muster Roll

for *Jan'y & Feb'y*, 1865.

Present or absent *Present*

Stoppage, \$ *100* for

Due Gov't, \$ *100* for

Valuation of horse, \$ *100*

Valuation of horse equipments, \$ *100*

Remarks: *Due us for advance \$ 1.90*

Book mark:

Butts
Copyist.

G | 1 Cav. | U.S.C.T.

William Young

No., Co. I, 1 Reg't U. S. Col'd Cavalry.

Appears on

Company Muster Roll

for Mar & Apr, 1865.

Present or absent Present

Stoppage, \$ 100 for

Due Gov't, \$ 100 for

Valuation of horse, \$ 100

Valuation of horse equipments, \$ 100

Remarks:

Book mark:

(358)

Copyist.

G | 1 Cav. | U.S.C.T.

William Young
Plt, Co. I, 1 Reg't U. S. Col'd Cavalry.

Appears on

Company Muster Roll

for *May June*, 186*5*.

Present or absent *Present*

Stoppage, \$ *100* for

Due Gov't, \$ *100* for

Valuation of horse, \$ *100*

Valuation of horse equipments, \$ *100*

Remarks:

Book mark: -----

(358)

Leuty
Copyist.

G | 1 Cav. | U.S.C.T.

William Young

Pr, Co. I, 1 Reg't U. S. Col'd Cavalry.

Appears on

Company Muster Roll

for *July & Aug*, 1865.

Present or absent *Present*

Stoppage, \$ *100* for

Due Gov't, \$ *100* for

Valuation of horse, \$ *100*

Valuation of horse equipments, \$ *100*

Remarks:

Book mark: _____

(358)

Cutter
Copyist.

Y. | 1 Cav. | U.S.C.T.

William Young.

Pr., Co. I, 1 Reg't U. S. Col'd Cavalry.

Appears on

Company Muster Roll

for *Sept - Oct.*, 186*5*.

Present or absent *Present*

Stoppage, \$ 100 for

Due Gov't, \$ 100 for

Valuation of horse, \$ 100

Valuation of horse equipments, \$ 100

Remarks:

Book mark:

(358)

Kelly

Copyist.

Y. | 1 Cav. | U.S.C.T.

William Young.

Pi., Co. I, 1 Reg't U. S. Col'd Cavalry.

Appears on

Company Muster Roll

for *Nov. + Dec*, 186*5*.

Present or absent *Present*

Stoppage, \$ 100 for

Due Gov't, \$ 100 for

Valuation of horse, \$ 100

Valuation of horse equipments, \$ 100

Remarks:

Book mark:

(358)

Kelly,

Copyist.

Y. | 1 Cav. | U.S.C.T.

William Young

P., Co. *I*, 1 Reg't U. S. Col'd Cavalry.

Appears on Co. Muster-out Roll, dated

Ortiz Santiago Tex, Feb. 4, 1866.

Muster-out to date *Feb. 4*, 1866.

Last paid to *Aug. 31*, 1865.

Clothing account:

Last settled _____, 186 ; drawn since \$ _____ 100

Due soldier \$ *7.61* 100; due U. S. \$ _____ 100

Am't for cloth'g in kind or money adv'd \$ _____ 100

Due U. S. for arms, equipments, &c., \$ _____ 100

Bounty paid \$ _____ 100; due \$ *100.00* 100

Remarks: *Joined at Orig. Co.
Free before Apr 19/61*

Book mark: *44614 = 1889 R & P O*

(361)

Kelly

Copyist.

Cf. I. Gay U.S. Col'd

Wm. J. Young

Co. I. 1. Reg't 1st Cavalry

NOTATION.

Book mark: *RTP 44614*

War Department,

Record and Pension Division,

Washington, *Oct 29*, 1889.

*Certificate in lieu
furnished to the
claimant*

O. C. [Signature]

1544

Jack

Co. F. V. S., 1 U. S. Col'd Cav.

Servant.

Servant.

CARD NUMBERS.

1	5300837	26
2		27
3		28
4		29
5		30
6		31
7		32
8		33
9		34
10		35
11		36
12		37
13		38
14		39
15		40
16		41
17		42
18		43
19		44
20		45
21		46
22		47
23		48
24		49
25		50

Book Mark:

See also

Z

1 Car. | U.S.C.T.

Zach.

Rank Servant, Reg't U. S. Col'd.

Appears on

Field and Staff Muster Roll

for Jan. + Feb. 186 4

Present or absent

Stoppage, \$ 100 for

Due Gov't, \$ 100 for

Valuation of horse, \$ 100

Valuation of horse equipments, \$ 100

Remarks:

(Servant to Surgeon B. S. Manly.)

Not found on other rolls of F. & S.

Book mark:

McDavis

1545 End

Joe

Co F + S, 1 U. S. Col'd Cav.

Servant

Servant

CARD NUMBERS.

1	9300863	26
2		27
3		28
4		29
5		30
6		31
7		32
8		33
9		34
10		35
11		36
12		37
13		38
14		39
15		40
16		41
17		42
18		43
19		44
20		45
21		46
22		47
23		48
24		49
25		50

Book Mark :

See also

Z

1 Cav. U.S.C.T.

Loe

Rank *Servant* Reg't U. S. Col'd

Appears on

Field and Staff Muster Roll

for *March & April* 186 *4* *5*

Present or absent

Stoppage, \$ *100* for

Due Gov't, \$ *100* for

Valuation of horse, \$ *100*

Valuation of horse equipments, \$ *100*

Remarks:

*(Servant to Surg. Bradford
S. Manly.)*

Not found on other rolls of F & S

**Compiled by Thos. E. Hatch Esq*

Book mark:

McDavis

ROLL

16

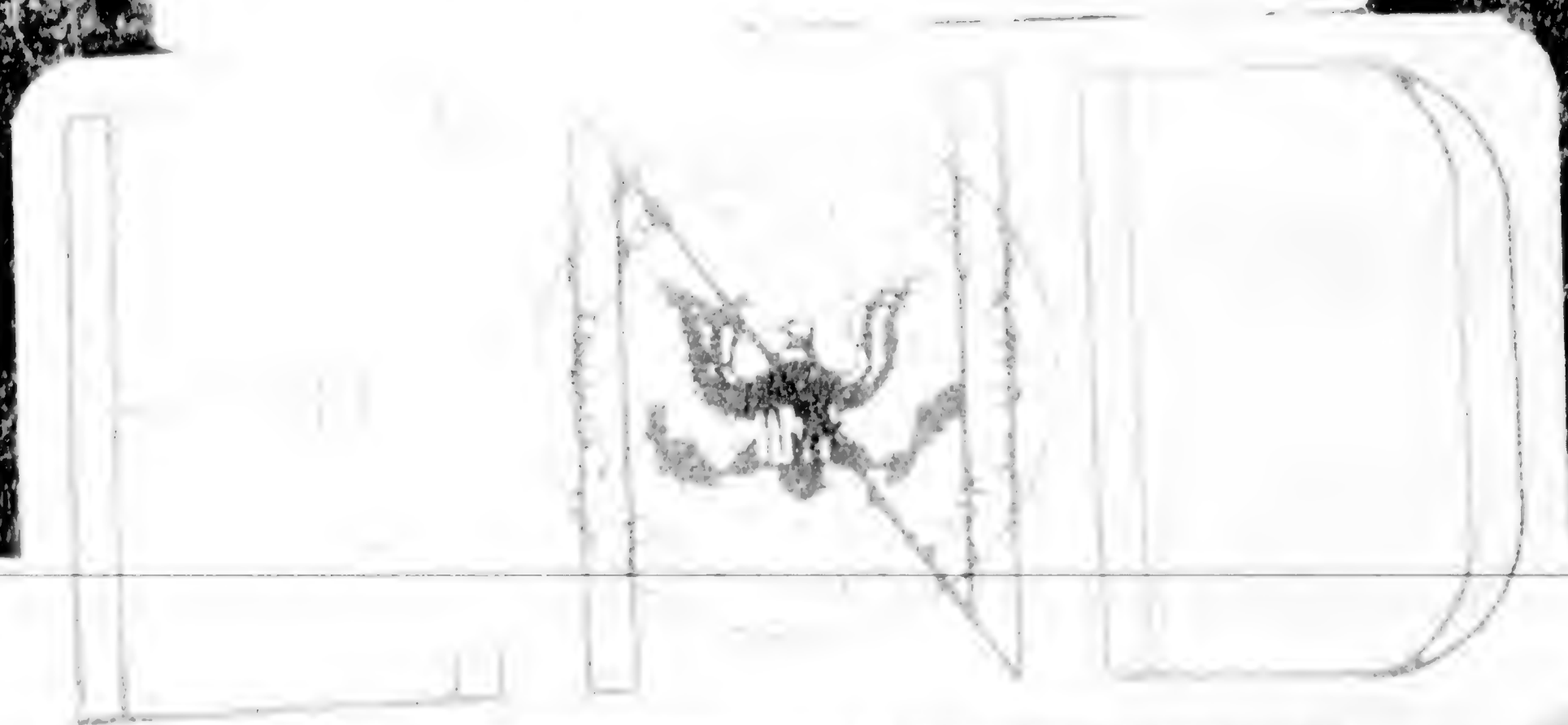

MICROCOPY

18 17

COPY

IMAGE EVALUATION TEST TARGET (QA-3)

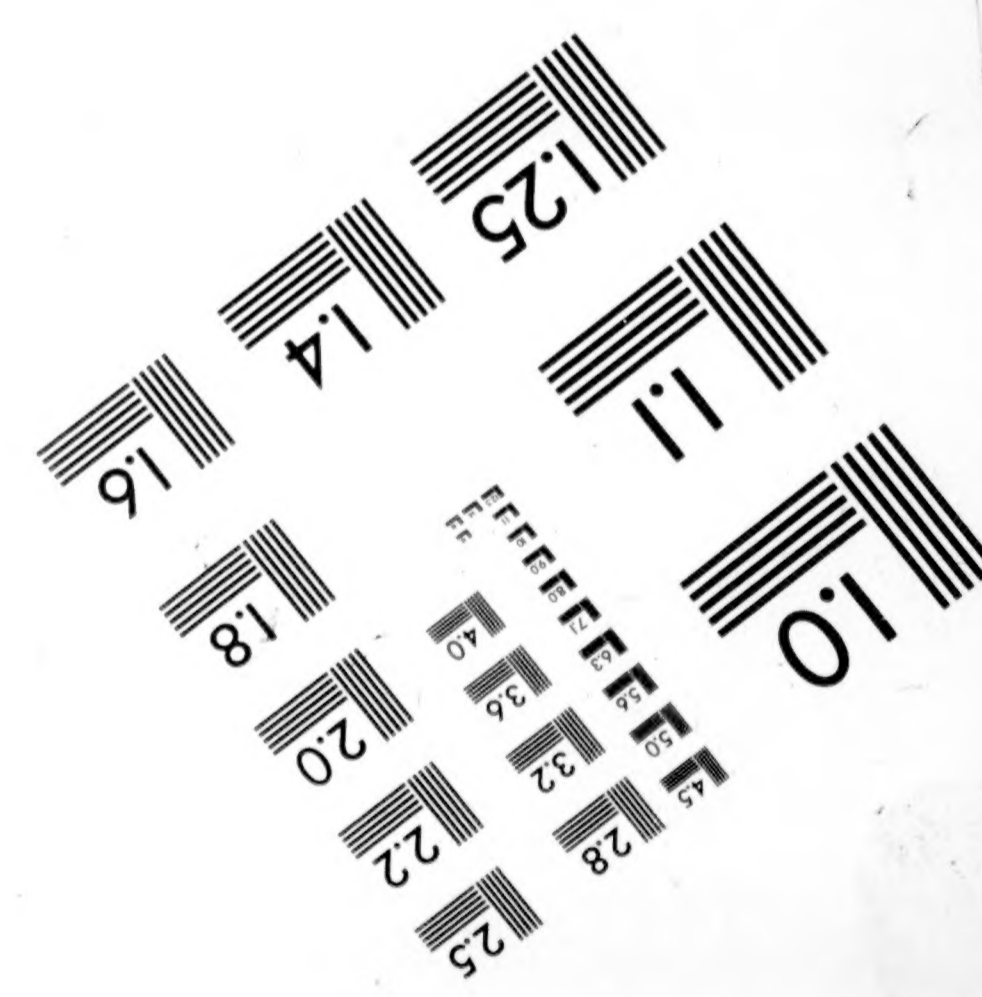
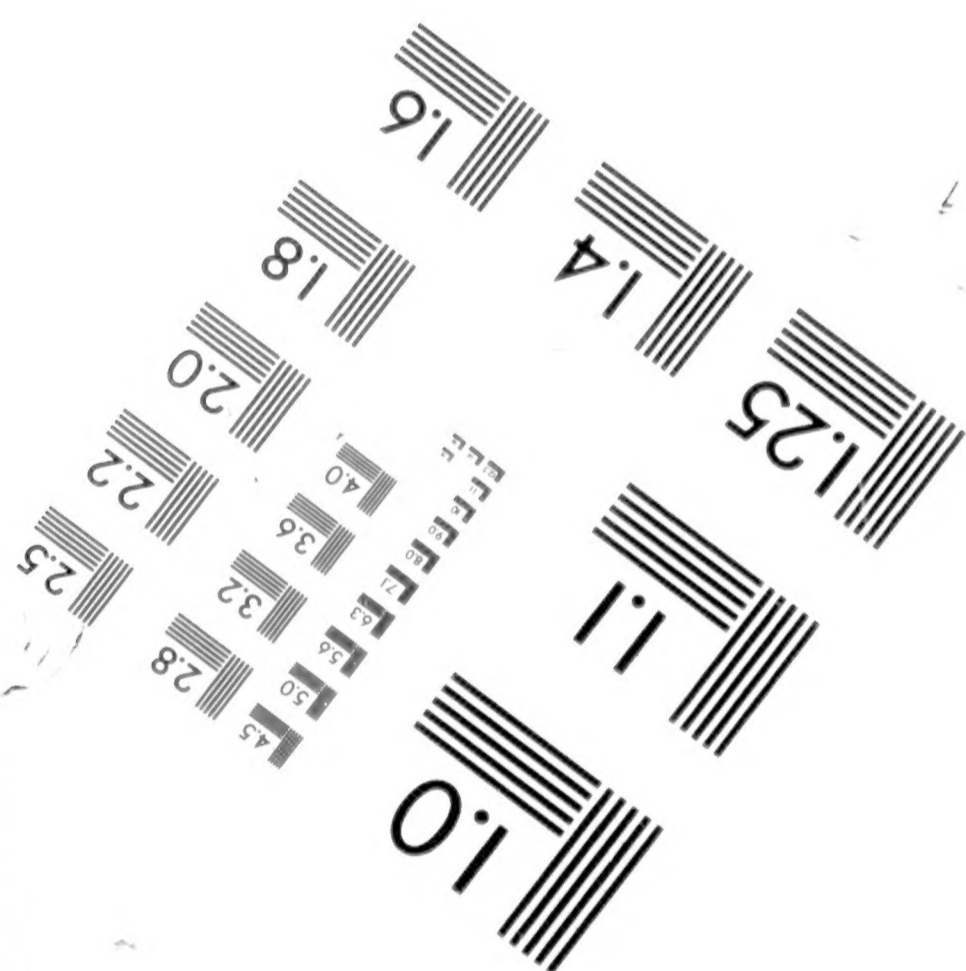
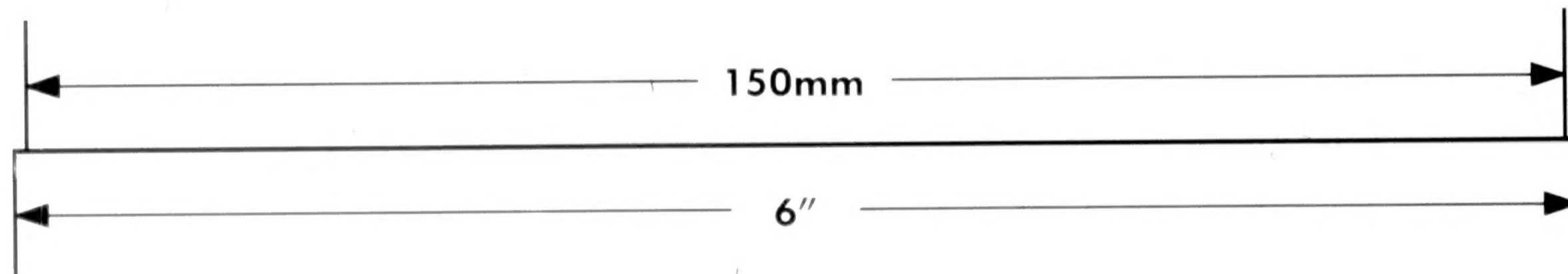
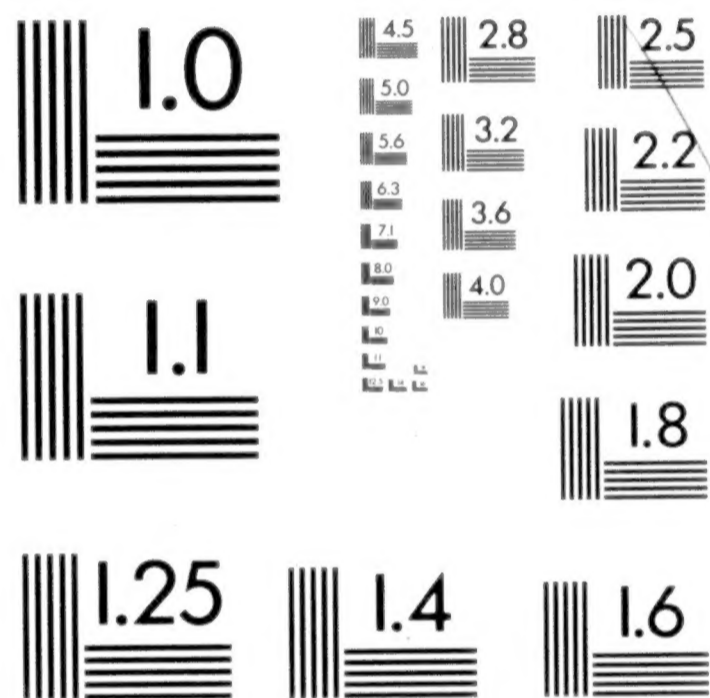
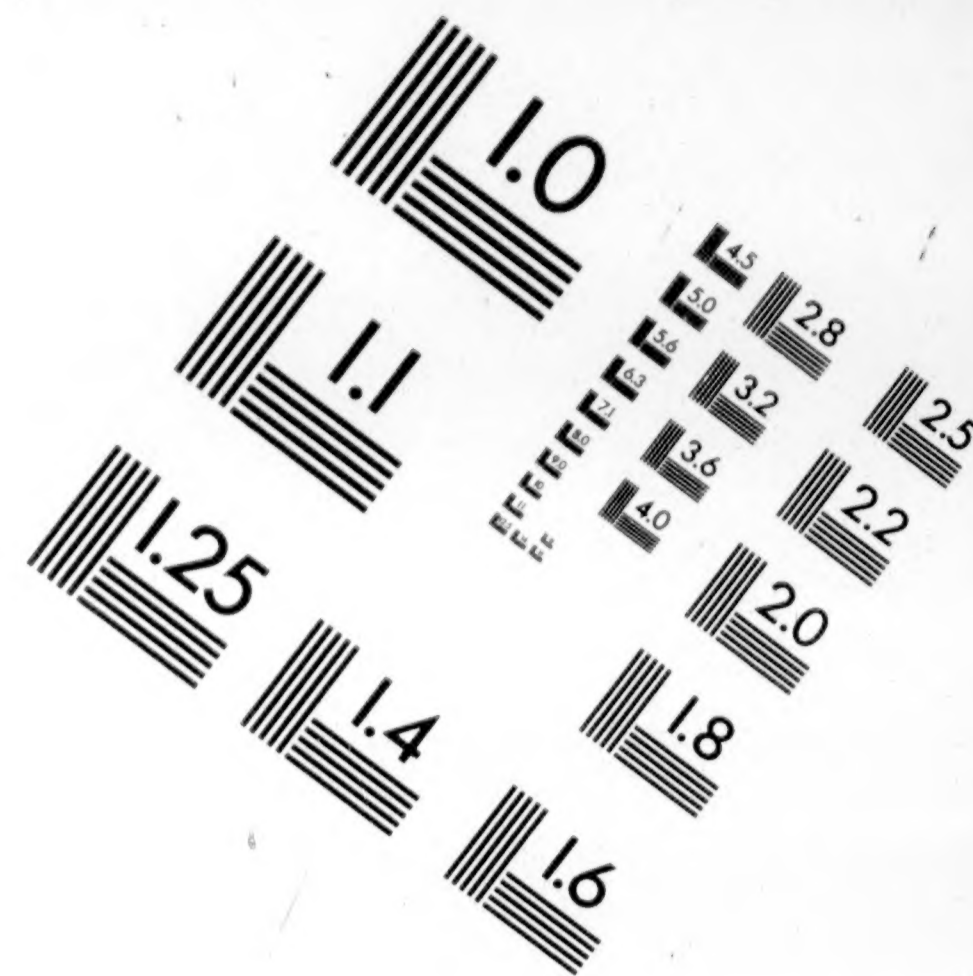
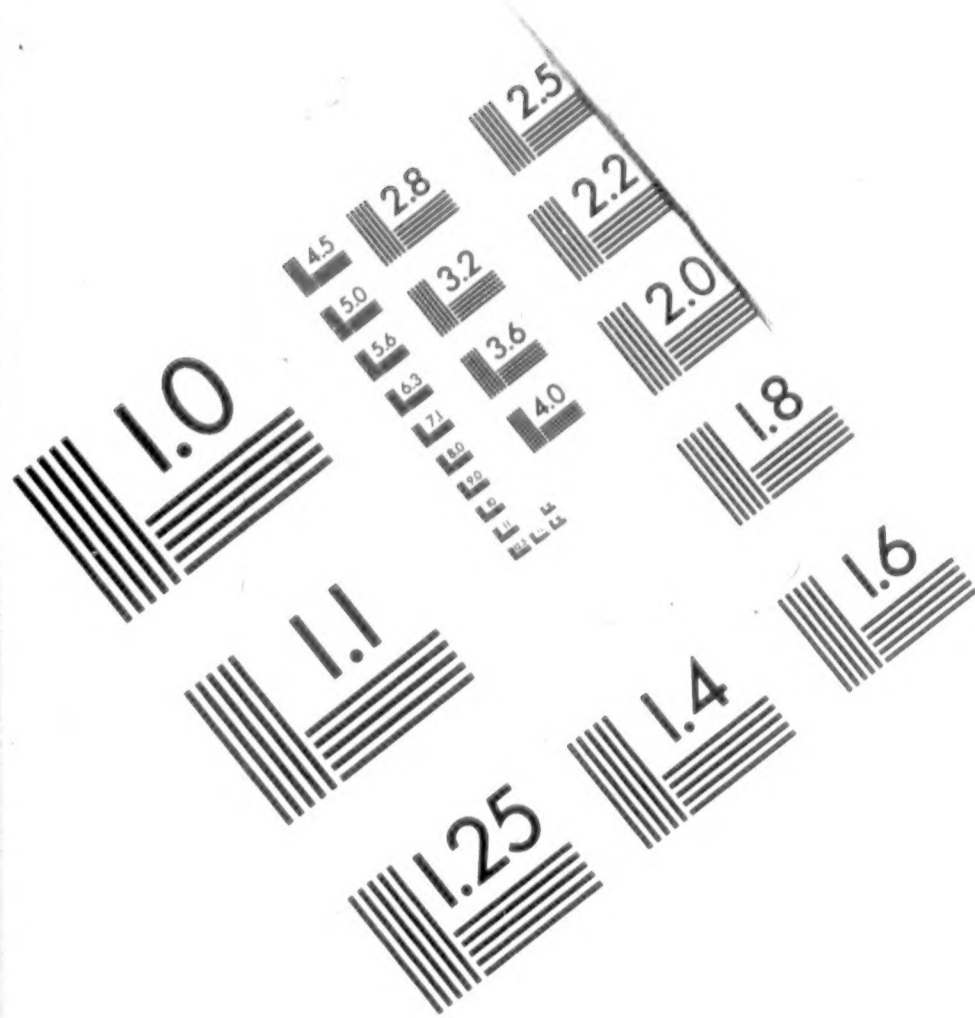

APPLIED IMAGE, Inc
 1653 East Main Street
 Rochester, NY 14609 USA
 Phone: 716/482-0300
 Fax: 716/288-5989

© 1993, Applied Image, Inc., All Rights Reserved

THE END

PLEASE

REWIND

